



RUBI



CATALOGUE 2024

**THE PROFESSIONAL'S
CHOICE SINCE 1951**

07.	Mixing
172	Electric Mixers
180	Mixing Paddles

08.	Tools for fixing tiles and Finishings
190	Trowels, Notched trowels, Floats, Rubber trowels and Spatulas
206	Markers, Chisels, Templates and Auxiliary tools for tiling
214	Mallets, Nippers and Grout Mortar Applicators

09.	Accessories for tile fixing and Finishing
222	Measurement and guides
224	Tile Spacers
230	Levelling Systems

10.	Rubble chutes, buckets & tubs
238	Rubble Chutes
240	Plastic Products for Construction

11.	Safety equipment
246	Safety equipment for building professionals

12.	Accessories for cleaning and Finishing
252	Products and Accessories for cleaning and Finishing of tiles

13.	Pal box and displays
260	Palbox and displays
269	Index by References





THE BEST OPTION FOR EACH JOB SINCE 1951

At RUBI Group, we are experts in the design, manufacture and distribution of revolutionary machinery and tools for cutting, laying and maintaining tiles. Our relentless dedication to excellence has positioned us as the undisputed leaders in the industry. Every product we create is the result of our passion for innovation and our unwavering commitment to quality.

With the invention of the first hydraulic mosaic tile cutter in history, invented and patented by the Boada brothers in 1951, RUBI has always worked with a clear mission: to provide differentiated solutions to construction professionals by providing maximum efficiency, profitability and safety for the optimal installation of ceramic tiles.

In this way, by placing the installer at the centre of our strategy, we ensure that **innovation, the high quality of our products and excellence are fundamental principles throughout our product range.** The RUBI brand is currently recognised by the most demanding construction and design professionals in more than 120 countries, thanks to our robust international network of subsidiaries and branches.

WE PROVIDE QUALITY AND INNOVATION TO THE WORLD





RUBI IS RUBI ALL OVER THE WORLD

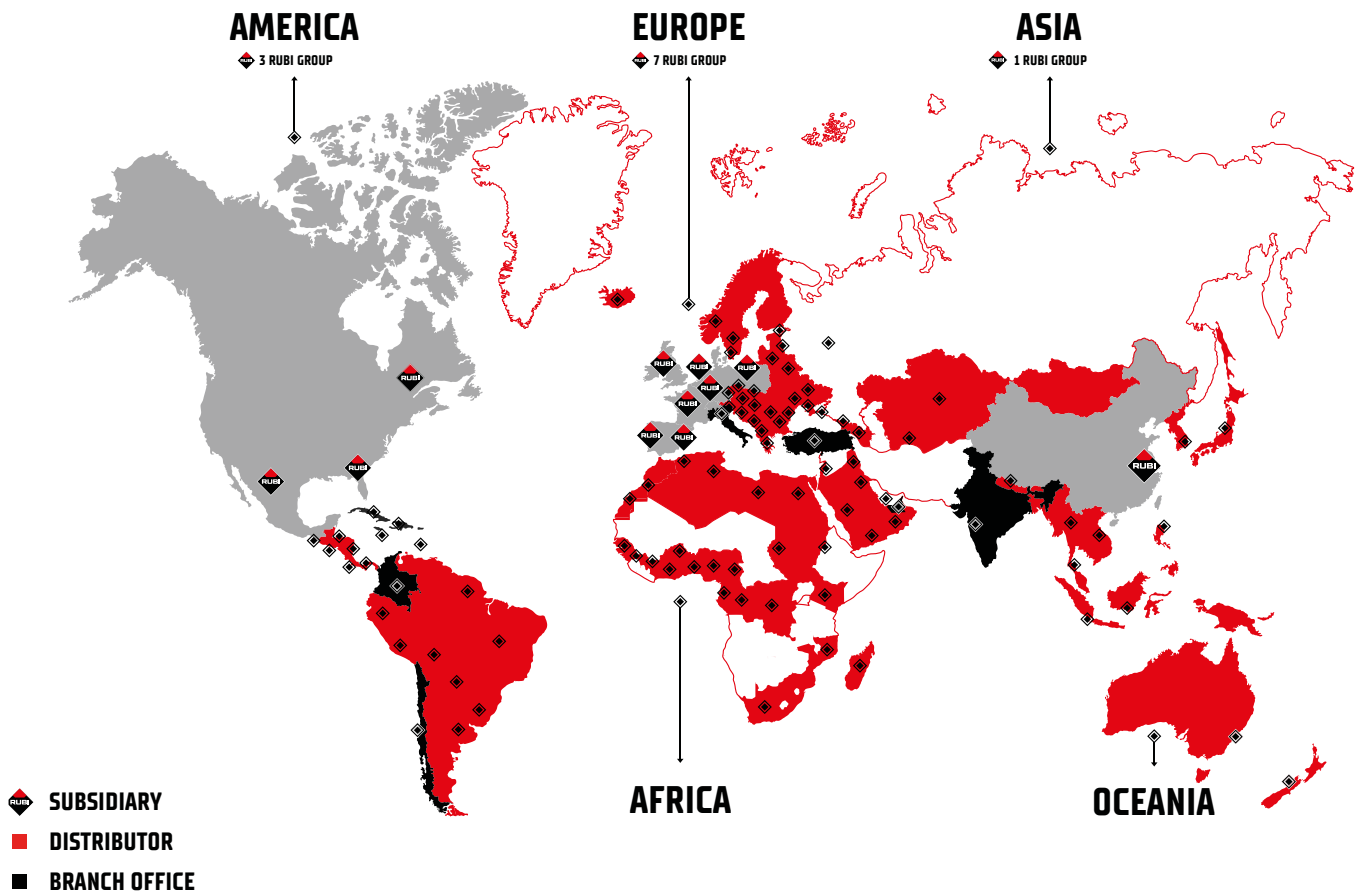

+600 People in the RUBI Team

120 Countries with RUBI brand distribution

2 Production and logistics centres

+100 Official Distributors

11 International subsidiaries

At RUBI Group, our multidisciplinary team is highly qualified and undergoes continual training. We are firmly committed to excellence, respect and passion, core values that guide our actions every day.

Our team is made up of more than 600 professionals in 11 subsidiaries and 9 branches around the world. Our experience and know-how support us in providing quality solutions at an international level.



BETTER PROFESSIONALS. BETTER PLACES.

THE RUBI 'BETTER PROFESSIONALS, BETTER PLACES' COMMITMENT.

At RUBI Group we are guided by our corporate purpose "Better Professionals. Better Places" that reflects our focus on two fundamental aspects, improving the quality and performance of our industry through the professionals whose talent is recognised by all, as well as the places they transform with their creativity.

We strive to change the future by being leaders in training exceptional professionals and contributing to building exceptional places, for the benefit of a better world.



Training for construction students at the BTP CFA apprenticeship centre in Antibes, France.

SDG FOR A SUSTAINABLE AND EQUITABLE FUTURE

Our commitment focuses on sustainable development as part of our Corporate Social Responsibility strategy, which encompasses the three key areas of sustainability: social, environmental and economic.

In doing so, we draw on 8 of the 17 Sustainable Development Goals (SDGs) set by the United Nations for the period 2015–2030, which guide us on our path towards a future with a focus on sustainability.

We firmly believe that environmental policies and social and economic sustainability are the responsibility of the



Collaboration with the Vicente Ferrer Foundation in the construction of housing for vulnerable people in Anantapur, India.



entire RUBI team. Only in a fairer, more equal and more sustainable world can we continue growing and working together with society and our environment.

TOGETHER WE ARE BUILDING A SUSTAINABLE AND EQUITABLE FUTURE FOR ALL.



Beach clean-up in Florida by RUBI Tools USA team.



At Rubi we are a multidisciplinary team with great expertise and ongoing training.

The RUBI Team, made up of more than 600 professionals, works in the numerous subsidiaries and branches that the RUBI Group has at international level.

OUR DAY-TO-DAY WORK IS ALWAYS CARRIED OUT ACCORDING TO THE 3 RUBI VALUES





EXCELLENCE

Excellence defines us in all we do, thanks to our experience, flexibility and innovation. We strive each day to offer the best in our innovative products and our relationships with partners in the sector.

RESPECT

Respect is in our DNA, our relationships within the RUBI Team as well as with customers, suppliers and other stakeholders enable us to create a close-knit and dynamic environment.

PASSION

Passion is what moves us, our attitude to work through our commitment, optimism and determination. Our long history demonstrates our sustained enthusiasm over time – we love to inspire others.

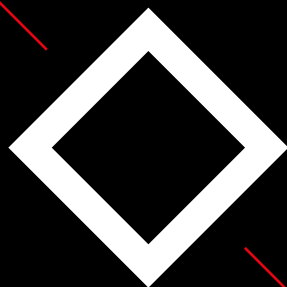

RUBI ACADEMY

LET'S BUILD BETTER PLACES TOGETHER!

The RUBI Academy is a pioneering project designed to professionalise and promote the tiler's trade, aimed at present and future ceramics professionals.

With more than 70 years' experience in training and supporting ceramic tile installers, we bring together all our training activities in an inclusive and accessible space: the RUBI Academy.

The RUBI Academy promotes learning opportunities through a wide range of international training events, webinars, downloadable tutorials and audio-visual content available on our website.

In addition to these training actions, the RUBI Academy supports initiatives such as the "RUBI Scholarship", which promotes specialisation in tile installation among young students and collaborates in training events aimed at women in the construction industry or unemployed people who are continuing their training.

The main base of the RUBI Academy is located in our facilities in Santa Oliva, where it has a physical space dedicated to training. It has a classroom for theory classes and another space with more than 580 square metres for practical training.

In this way, the RUBI Academy is consolidated as an accessible and quality training space, which also serves as an in-person and virtual meeting point for professionals in the sector. We value and raise the profile of the tiler's trade, bringing it closer to people and acknowledging the important role of ceramic tile installers in the construction industry.



**FOLLOW US ON
OUR YOUTUBE
CHANNEL
TO SEE ALL
THE TRAINING
VIDEOS**

4 **QUALITY
EDUCATION**

8 **DECENT WORK
AND ECONOMIC
GROWTH**

17 **PARTNERSHIPS
TO ACHIEVE
THE OBJECTIVES**





PRODUCTION FACILITIES

RUBI Group has 2 production centres in Santa Oliva (Tarragona, Spain) and Suzhou (China), which translates into more than 120,000 m² of facilities worldwide.

Our main production and logistics centre in Santa Oliva (Tarragona, Spain) covers a surface area of 27,000 m² and is equipped with the most advanced technology for logistics management. Moreover, thanks to the innovative SRT centre (Suzhou, China) we guarantee the stock availability of our products throughout the different geographical areas in which RUBI operates, meeting demanding service level ratios. Both production centres are also equipped with the latest production and logistics technology to ensure that we obtain high-quality products and a shipping service that minimises delivery times.



SHOWROOMS IN SUBSIDIARIES

RUBI's 11 subsidiaries cover global demand and the training and after-sales service, together with our trusted distributors, so we are always close to the user and can offer them solutions adapted to the characteristics of each market. In addition, in several of them, including our headquarters, we have modern showrooms displaying our latest market launches. We offer, in this way, an updated and innovative experience to our customers and users, showing how RUBI products meet the needs of the tiler in line with the new trends in the ceramic industry.



Showroom at RUBI Portugal's premises

CORPORATE MUSEUM

Since 1951, the RUBI team has been passionately devoted to professionalising the construction trades. As a reflection of our commitment, in 2003 we opened "The Tools of Construction" Corporate Museum at our main facilities in Santa Oliva, Tarragona. The museum is open to customers, professionals and students, providing them with a unique educational experience. They will be able to explore our historical collection of RUBI construction tools and test their skills in cutting and laying tiles.

HISTORY AND
INNOVATION COME
TOGETHER TO DRIVE
GROWTH AND
EXCELLENCE IN THE
SECTOR.



AFTER-SALES SERVICE

RUBI's after-sales team, together with our extensive network of official technical services, work daily to deal as efficiently as possible with incidents and any questions and needs our customers and professionals may have regarding the cutting and laying of ceramic tiles.

At RUBI Group, we lead the market with high and fast response rates, thus achieving exceptional customer satisfaction worldwide. We guarantee superior performance in our tools, providing a long-lasting and satisfying purchasing experience with impeccable customer service.

There are a number of ways for you to contact us:



rubi.com



aftersales@rubi.com



+34 936 80 65 00





RUBI CLUB

RUBI CLUB members are always one step ahead of other tile laying professionals, thus gaining greater profitability and prestige for their business.

At RUBI, all products give you points that can be conveniently changed for money or gifts, and you get great discounts just for registering your purchases. You can also extend the useful life of your tools, with the free warranty extension of up to 5 years, and get the most out of your investments. Thanks to our new products and exclusive promotions for RUBI CLUB members, you can work with the best tools under the best conditions.

Currently, more than 70,000 experts in the art of tile laying around the world already trust CLUB RUBI to make them better professionals and deliver their projects in the most efficient way.

Join the top community of tile laying experts worldwide and benefit from all its advantages!



GET MONEY BACK ON YOUR PURCHASES



EXTEND THE WARRANTY FREE OF CHARGE



ACCESS EXCLUSIVE PROMOTIONS



RECEIVE INVITATIONS FOR EVENTS



ENJOY UNIQUE CONTENT



PARTICIPATE IN COMPETITIONS AND DRAWS





RUBI CLUB

★★★★★ THE APP THAT REWARDS YOUR TRUST IN US

Get money back on all your purchases

DOWNLOAD THE APP AND START ENJOYING ALL THE BENEFITS

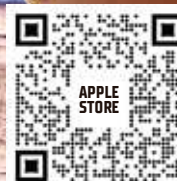

DOWNLOAD IT AND START ACCUMULATING POINTS

Scan the QR code or find it in app stores



At RUBI, innovation and quality are fundamental pillars in everything we do: from the conception of the design, through the production phase, and finally reflected in our products. We are proud to offer solutions that enable the tiling professional to carry out their work with creativity and good attention to detail, obtaining optimum results of the highest quality.

TECHNOLOGICAL LEADERSHIP

- 119** Patented products
- 119** Protected products with industrial design





INNOVATION

We are constantly researching and developing new solutions based on the evolution of market and technology trends, our own experience and ongoing conversations with end users, our partners and other professionals.

QUALITY

We only use materials of the highest quality and we work in compliance with strict design and manufacturing standards in order to offer tools with the performance levels that our customers expect.

GUARANTEE

We strive to offer greater durability in our products and a peace of mind that comes from our long track record, also backed up by a customer support service and constant communication with the same global nature.

SOLUTIONS

Understanding and helping to shape our industry for generations has allowed us to create a wide range of tools that provide excellence and efficiency in the cutting and laying of tiles.



PARTNERSHIP WITH CAS

RUBI & CAS work to offer professionals battery-powered tools for ceramic tile installation with total freedom of movement. CAS batteries are compatible with more than 35 brands and over 300 products, making it a low-cost, high-performance solution for tilers. From RUBI, we have created and launched 4 innovative and revolutionary products with this leading technology.

MIXER
RUBIMIX E-10
ENERGY

18V



- Brushless Motor
High efficiency
- Light
- Ergonomic
Resistance
- FAST-IN
included

THUMPING SYSTEM
QUAKE
ENERGY

18V



- Stepless speed
0-10000r/min
- Highly
ergonomic
- Bimaterial
handles
- Reliable
suction force
- Light

18V CAS Li-Ion 18V battery compatible with Metabo 18V cordless tools and all of those that form part of the CAS platform.

THUMPING SYSTEM
RUBI TRILLER
ENERGY

12V



- 3-100 mm
1/8"-3 15/16"
- 4,8 Kg
11 lb
- Vibration speed
regulator

SUCTION CUP
OCTO-PLUS
ENERGY

12V



- * Max.
150 kg · 331 lb
- Bi-material
handle
- Pressure
sensor
- Ergonomic
- LED
indicator

12V CAS Li-Ion 12V battery compatible with Metabo 12V cordless tools and all of those that form part of the CAS platform.



CAS BATTERIES

12/18V 2.0/4.0/5.2AH



Battery-powered tools for tile installers

1 COMPATIBLE WITH MORE THAN 35 BRANDS AND OVER 300 PRODUCTS

2 FREE MOVEMENT



Save time



1 battery pack for many brands



Save money



Save resources



Largest multi-manufacturer battery pack system



100% compatible

CAS BATTERY COMPATIBILITY



18 V 5.2 Ah	✓	✓	✗	✗
18 V 2.0 Ah	✓	✓	✗	✗
12 V 2.0 Ah	✗	✗	✓	✓
12 V 4.0 Ah	✗	✗	✓	✓

The charger is compatible with all batteries.



THE RUBI EXPERIENCE

5 STEPS TO EXCELLENCE

RUBI ensures quality, efficiency and creativity from start to finish at every stage of the tile installation process.

This basic signage across our entire product range helps the professional find the right tool for the task at hand, providing a clear and visual solution.

Our portfolio is now organised into these 5 categories, which have been defined taking into account our customers' testimonials about their own work processes, in the more than 120 countries where we operate.



1. Preparation

This phase includes all the processes prior to the installation of ceramic and porcelain tiles, starting with the preparation and making good of the substrates and the checking of levels, followed by the layout and design of the joint pattern and ending with the preparation and application of the tile adhesive.



2. Cutting and Drilling

Although after the preparation of the adhesive, this logically takes us to the installation stage, RUBI has included the cutting and drilling phase in second place. The reason is very simple, if we take into account that the tile needs to be cut (or drilled), it cannot be installed until this step has been carried out. All installations require tiles to be adapted and resized to the installation space and, whether it is to a greater or lesser extent, a ceramic tile will always have to be cut (or drilled).



3. Installation

In this stage, we mainly focus on bringing together all the necessary tools to ensure proper handling and installation of the tile, obtaining the best results both in flatness and alignment in order to make the setting-out design a reality with maximum precision.



4. Grouting

As its name indicates, this stage includes all the tools necessary for the filling and definition of the tile joint, as well as the removal of excess material and a first cleaning stage.



5. Cleaning

As it must do, the last stage brings together everything that is necessary to deliver the perfect job. The final cleaning of any ceramic tile installation process will always make the first impression on any user. For this reason, it is as important as any of the previous stages.













MANUAL TILE CUTTING

Manual Tile Cutters
Scoring wheels and accessories for manual cutters

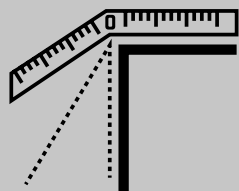

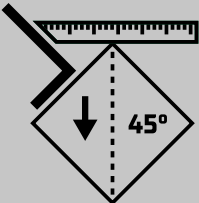

SELECTION TABLE

			MAX 	
			cm	inch
 Adjustable from 0°-45°	PREMIUM 	TZ	85, 102, 130, 155, 180	33 ¹ / ₁₆ , 40 ³ / ₁₆ , 51 ³ / ₁₆ , 61 ¹ / ₁₆ , 70 ⁷ / ₁₆
		TX-MAX	71, 102, 125	27 ¹ / ₁₆ , 40 ³ / ₁₆ , 49 ³ / ₁₆
	SUPERPRO 	TP-S / TP-T	66, 75, 93, 125	26, 29 ¹ / ₂ , 36 ⁵ / ₁₆ , 49 ³ / ₁₆
TR-MAGNET		60, 71	23 ⁵ / ₁₆ , 27 ¹ / ₁₆	
 Fixed 0°/45°	PRO 	HIT PLUS RS	160	63
		HIT PLUS	120, 160, 180	47 ¹ / ₄ , 63, 70 ⁷ / ₁₆
		HIT N	85, 100, 120	33 ³ / ₁₆ , 39 ³ / ₁₆ , 47 ¹ / ₄
		TS MAX	43, 57, 66, 75	16 ¹ / ₁₆ , 22 ³ / ₁₆ , 26, 29 ¹ / ₂
		SPEED MAGNET	62, 72, 92	24 ⁷ / ₁₆ , 28 ³ / ₈ , 36 ¹ / ₄
Ocasional 	SPEED N	62, 72, 92	24 ⁷ / ₁₆ , 28 ³ / ₈ , 36 ¹ / ₄	
	FAST	65, 85	25 ⁵ / ₁₆ , 33 ³ / ₁₆	
	STAR PLATINUM	51, 63	20 ¹ / ₁₆ , 24 ¹ / ₁₆	
	STAR	42, 51, 63	16 ⁵ / ₁₆ , 20 ⁵ / ₁₆ , 24 ¹ / ₁₆	
Ocasional 	PRACTIC	51, 61	20 ⁷ / ₁₆ , 24 ¹ / ₁₆	
	BASIC	60	24	



kg	lb		mm	inch	TILE	STONEWARE	PORCELAIN
1500	3306.93	Adjustable	21*	1 ¹ / ₆	○	○	○
1200	2645.54		21*	1 ¹ / ₆	○	○	○
1000	2204.62		20*	1 ¹ / ₆	○	○	○
800	1763.7		15	5/8	○	○	○
900	1984.16	Fixed	18	1 ¹ / ₆	○	○	○
					○	○	○
					○	○	○
800	1763.7		15	5/8	○	○	○
					○	○	○
			15	5/8	○	○	
			12	5/8	○	○	
					○	○	
					○	○	
			10	5/8	○	○	
		○					

TZ

MAXIMUM POWER, THE MOST ADVANCED MANUAL CUTTER ON THE MARKET.

For intensive cutting of all types of ceramic tile, ideal for porcelain stoneware and extruded stoneware.



Category

**PREMIUM**

Use

**INTENSIVE**

Material

**PORCELAIN TILE**

1500 kg

**POWER**13/16"
21 mm3307 Lb
1500 kg**PURE
POWER****PATENTED**

- **Powerful breaking system (up to 1.500 kg), operable with just one hand.**
- **Accurate with soft slider movements.**
- **Large cutting capacity, up to 21mm thickness. Ideal for large format tiles*.**
- **Robust with a foldable structure for high strength and easy transportation.**
- Excellent performance breaking system: Clean cuts with soft motion.
- Robust chassis, guides and breaking system.
- Swivel square with central pivot for fast and accurate measurements in angle cutting.
- Adjustable lateral stop for repetitive cuts.
- Support base for excellent tile placement.
- Easy to transport: rubber wheels with bearings and handle.
- Interchangeable scoring wheels ranging from Ø 8mm -22mm.
- Includes Ø 8 mm SILVER and Ø 22 mm EXTREME scoring wheels. Reinforced textile bag for transport and protection.
- On models 1300/1550/1800:
 - The reinforced textile bag of these models includes 2 built-in wheels.



	REF.								
TZ-850	17952	√	33 7/16" 85 cm	24x24" 60x60 cm	1/8-13/16" 3-21 mm	3307 Lb 1500 kg	49.4 Lb 22.4 kg	12	
TZ-1020	17951		40 3/16" 102 cm	27 9/16x27 9/16" 70x70 cm			54.2 Lb 24.6 kg		
TZ-1300	17953		51 3/16" 130 cm	35 7/16x35 7/16" 90x90 cm			66 Lb 30 kg	1	9
TZ-1550	17954		61 1/16" 155 cm	43 5/16x43 5/16" 110x110 cm			73 Lb 33 kg		
TZ-1800	17924		70 7/8" 180 cm	47x47" 120x120 cm			79.94 Lb 36.26 kg	6	

*Some materials with a thickness greater than 15 mm may be difficult to cut manually due to physical characteristics, internal tensions and/or finish. We recommend making sample cuts to determine product compatibility and alternatively suggest cutting these types of material using an electric tile cutter.

ACCESSORIES



REF. 18980
Maintenance Kit

TX-MAX

PROFESSIONAL MANUAL CUTTER WITH HIGH-PERFORMANCE MULTIPOINT BREAKER.
For intensive cutting of all types of ceramic tile, ideal for porcelain stoneware and extruded stoneware.



Category



PREMIUM

Use



INTENSIVE

Material



PORCELAIN TILE

1200 kg



POWER



PATENTED

- **Highly precise scoring.**
- **Entire system highly efficient.**
- **Reinforced components. Heavy duty.**
- **High breaking power (1,200 kg) – MASTER POWER. One-handed operation.**
- Head with extra-long aluminium sliders with “self-lubricating” friction bearings.
- Portable breaker with aluminium pressure pad, equipped with plastic protector to avoid marking delicate surfaces. Better visibility of the scoring and cutting zone.
- The pressure pad is locked by a ratchet mechanism and is unlocked by the trigger, allowing one-handed scoring and breaking for faster use. Increases performance with both thin and thick materials.
- Injected-aluminium base, reinforced with a central rib, for increased strength.
- Floating tables and supplementary arms for large-size ceramic tile, increasing cutting stability.
- Rotating square, with central pivot point and lateral end stop. Greater precision in angle cuts.
- Handle with soft grip for better ergonomics and comfort.
- Equipped with Ø 8 mm SILVER and Ø 22 mm EXTREME scoring wheels. Compatible with the entire plus line of scoring wheels.
- Includes a carrying case (the 1250 model is equipped with wheels to transport the machine).



	REF.								
TX-710 MAX	17909	√	27 15/16" 71 cm	20x20" 50x50 cm	1/8-13/16" 3-21 mm	2646 Lb 1200 kg	29.3 Lb 13.3 kg	1	10
TX-1020 MAX	17915		40 3/16" 102 cm	27 9/16x27 9/16" 70x70 cm			42.8 Lb 19.4 kg		
TX-1250 MAX	17921		49 3/16" 125 cm	33 7/16x33 7/16" 85x85 cm			57 Lb 26 kg		

* There are some materials over 15mm thick which, due to their physical properties, possible inner or surface tensions, are difficult to cut manually. It is recommended to make some sample cuts to determine the compatibility of the product.

ACCESSORIES



REF. 18980
Maintenance Kit







TP-S

SINGLE GUIDE WITH MULTIPOINT SEPARATOR AND ANGULAR MEASUREMENT.

Ideal for high quality cutting of ceramic and porcelain tiles.



Category

SUPERPRO

Use

INTENSIVE

Material

PORCELAIN TILE

MONOGUIDE



- **Guide system highly resistant to impacts resulting in longer product life.**
- **Ergonomic handle with incorporated separator for greater speed and ease of use.**
- **Swivel bracket with central pivot for fast and accurate measurements.**
- **Long-lasting laser engraved square.**
- Reinforced pressure pad.
- 12 mm reinforced guide. Greater bending resistance and increased precision.
- Lateral end stop for making repetitive precision cuts.
- Two-layer base with shock-absorbing effect. Base extension for large sizes. Carrying handle. (TP-66-S and TP-75-S).
- Assembly designed to be used by pushing the handle.
- RUBIFLEX bi-material handle.
- Ø 22mm EXTREME scoring wheel included. (Ref. 01901)



	REF.							
TP-66 S	12954	26" 66 cm	18 1/8x18 1/8" 46x46 cm	3/16-13/16" 5-20 mm	2205 Lb 1000 kg	25.4 Lb 11.5 kg	1	12
TP-75 S	12956	29 1/2" 75 cm	20 7/8x20 7/8" 53x53 cm			26 Lb 12 kg		
TP-102 S	11900	40 3/16" 102 cm	27 9/16x27 9/16" 70x70 cm			39.2 Lb 17.8 kg		
TP-125 S	11973	49 3/16" 125 cm	33 7/16x33 7/16" 85x85 cm			54 Lb 24.5 kg		

*Some materials with a thickness greater than 15 mm may be difficult to cut manually due to physical characteristics, internal tensions and/or finish. We recommend making sample cuts to determine product compatibility and alternatively suggest cutting these types of material using an electric tile cutter.

ACCESSORIES



REF. 18980
Maintenance Kit



TP-T

SINGLE GUIDE CUTTER WITH MULTIPOINT SEPARATOR AND ANGULAR MEASUREMENT.
Ideal for high quality cutting of ceramic and porcelain tiles.



Category

SUPERPRO

Use
●●●
INTENSIVE

Material

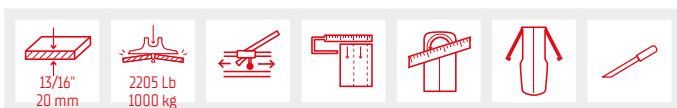
PORCELAIN TILE

MONOGUIDE



- **Single guide system highly resistant to impacts. Longer life.**
- **Separator set with height adjustment. Optimum separation for each thickness.**
- **Swivel bracket with central pivot for fast and accurate measurement of angular cuts.**
- **Long-lasting laser engraved square.**
- Reinforced pressure pad. 12 mm reinforced guide. Greater bending resistance and increased precision. Lateral end stop for making repetitive precision cuts. Two-layer base with shockabsorbing effect. Base extension for large sizes. Carrying handle. (TP-66-T and TP-75-T).
- Assembly designed to be used by pulling the handle.
- RUBIFLEX bi-material handle. Ergonomic and heavy duty construction.
- Cut thickness adjustment system with 3 settings (6-9 mm/9-12 mm/12-20 mm)*, fast and precise.
- Ø 22mm EXTREME scoring wheel included (Ref. 01901).



	REF.							
TP-66 T	12955	26" 66 cm	18 1/8x18 1/8" 46x46 cm	3/16-13/16" 5-20 mm	2205 Lb 1000 kg	25.4 Lb 11.5 kg	1	12
TP-75 T	12957	29 1/2" 75 cm	20 7/8x20 7/8" 53x53 cm			26 Lb 12 kg		
TP-102 T	11901	40 3/16" 102 cm	27 9/16x27 9/16" 70x70 cm			36.2 Lb 16.4 kg		
TP-125 T	11974	49 3/16" 125 cm	33 7/16x33 7/16" 85x85 cm			51 Lb 23 kg		

*Some materials with a thickness greater than 15 mm may be difficult to cut manually due to physical characteristics, internal tensions and/or finish. We recommend making sample cuts to determine product compatibility and alternatively suggest cutting these types of material using an electric tile cutter.

ACCESSORIES



REF. 18980
Maintenance Kit



TR-MAGNET

SUITABLE FOR DIAGONAL CUTS WITH A REVOLVING SQUARE FOR HIGH ACCURACY.
For intensive cutting of porcelain tiles and ceramic tiles.



Category

SUPERPRO

Use
●●●
INTENSIVE

Material

PORCELAIN TILE

SWIVEL SQUARE



- **Fast operating system with magnet, for one handed use.**
- **Reinforced operating material. Increased breaking power.**
- **Revolving square with central pivot for fast and accurate measurements for cutting angles.**
- **Floating base with shock absorber for better tile breaking.**
- Solid steel guides, Ø 20 mm, chrome-plated and rectified, with anti-corrosion treatment for increased torsional strength.
- Multipoint breaker 800 kg of power.
- Heavy-duty metal arms.
- Handle reinforced with SOFT-GRIP.
- Lateral end stop for making repetitive cuts.
- Base extension for large sizes.
- Two-layer base with shock-absorbing effect.
- High-strength aluminium base.
- Interchangeable scoring wheels from 6 to 22 mm.
- With Ø 10mm SILVER and Ø 22mm EXTREME scoring wheels and carrying case included.



	REF.								
TR-600 MAGNET	17905	✓	24" 60 cm	16 9/16x16 9/16" 42x42 cm	1/8-9/16" 3-15 mm	1764 Lb 800 kg	30.6 Lb 13.9 kg	2	18
TR-710 MAGNET	17906		27 15/16" 71 cm	20x20" 50x50 cm			34.2 Lb 15.5 kg	1	15

ACCESSORIES



REF. 18980
Maintenance Kit



HIT-PLUS / HIT-PLUS RS

ROBUST AND ACCURATE TILE CUTTER FOR THE MOST DEMANDING WORK ON LARGE FORMAT TILES.

For professional cutting of porcelain and ceramic tiles.



Category



SUPERPRO

Use

PROFESSIONAL

Material



PORCELAIN TILE

900 kg



POWER

- **Slider assembly with ball bearings for greater SMOOTHNESS and COMFORT during scoring.**
- **MAGNET System. The pressure pad for scoring and breaking can be locked and unlocked with one hand. FASTER use and cutting accuracy.**
- **Full view of the scoring and cutting area thanks to the forward position of the scoring wheel in front of the pressure pad.**
- **Closed extruded aluminium structure base for greater RIGIDITY and cutting CAPACITY.**
- With HIGH performance moving breaker.
- Ground, chrome-plated solid steel guides with anti-corrosion treatment, and 25 mm diameter for greater torsional strength.
- With a square that includes a side stop for repetitive and 45° cuts.
- Equipped with 4 additional aluminium arms for working with large ceramic tiles.
- Moving guides stop for adjusting the cut to the tile dimension.
- Double tile support with accessory for cutting at 45°.
- Handle with soft grip for better ERGONOMICS and COMFORT.
- Wide range of scoring wheels adaptable to each material (6, 8, 10, 18 and 22 mm diameter). Includes Extreme 22 mm scoring wheel.
- Equipped with 2 wheels and grip for better tool movement.
- The RS version includes a reinforced square with magnet fixing.
- The 1600 mm long versions include wheels for easier transport.
- The bag includes wheels for 1200, 1600 and 1800 option.



NEW!



HIT PLUS



3+1
YEARS
WARRANTY

1 2 3 4 5
Cut & Drill

	REF.									
HIT-1200 PLUS WITH BAG	27902	✓	47" 120 cm	33 7/16x33 7/16" 85x85 cm	1/8-11/16" 3-18 mm	1984 Lb 900 kg	45.2 Lb 20.5 kg	56 Lb 25.4 kg	1	24
HIT-1600 PLUS RS WITH BAG	27903		63" 160 cm	44 1/2" 113x113 cm			60 Lb 27 kg	71.6 Lb 32.5 kg		16
HIT-1200 PLUS	27900	47" 120 cm	33 7/16x33 7/16" 85x85 cm	48.3 Lb 21.9 kg			56.4 Lb 25.6 kg	24		
HIT-1600 PLUS	27909	63" 160 cm	39" 100x100 cm	49 Lb 22 kg			0 Lb - kg	16		
HIT-1600 PLUS RS	27901		44 1/2" 113x113 cm							
HIT-1800 PLUS	27916	70 7/8" 180 cm	50x50" 127x127 cm	60.1 Lb 27.26 kg			12			

ACCESSORIES



REF. 18980
Maintenance Kit



HIT-N

ROBUST AND ACCURATE FOR LARGE TILES.

For professional cutting of porcelain and ceramic tiles.



Category



SUPERPRO

Use



PROFESSIONAL

Material



PORCELAIN TILE

800 kg



POWER

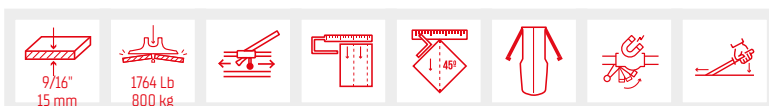

- **With high performance moving breaker.**
- **Slider assembly with ball bearings for greater smoothness and comfort during scoring.**
- **Full view of the scoring and cutting area thanks to the forward position of the scoring wheel in front of the pressure pad.**
- **Closed extruded aluminium structure base for greater rigidity and cutting capacity.**
- Ground, chrome-plated solid steel guides with anti-corrosion treatment, and 20 mm diameter for greater torsional strength.
- Guides fixed with clamps for greater rigidity.
- With side stop for repetitive and 45° cuts.
- Equipped with 4 additional aluminium arms, for large-sized ceramic tiles.
- Handle with soft grip for better ergonomics and comfort.
- Wide range of scoring wheels adaptable to each material (6, 8, 10, 18 and 22mm diameter).
- Includes 22mm scoring wheel.



NEW!



3+1
YEARS
WARRANTY

1 2 3 4 5
Cut & Drill

	REF.											
HIT-1000 N WITH BAG	26999	√	39" 100 cm	27 9/16x27 9/16" 70x70 cm			2749 Lb 1247 kg	31 Lb 14 kg	1	24		
HIT-1200 N WITH BAG	26962		47" 120 cm	33 7/16x33 7/16" 85x85 cm			2749 Lb 1247 kg	31 Lb 14 kg				
HIT-850 N	26963	-	33 7/16" 85 cm	24x24" 60x60 cm			1/8-9/16" 3-15 mm	1764 Lb 800 kg			24.69 Lb 11.20 kg	0 Lb - kg
HIT-1000 N	26992		39" 100 cm	27 9/16x27 9/16" 70x70 cm			2749 Lb 1247 kg					
HIT-1200 N	26961		47" 120 cm	33 7/16x33 7/16" 85x85 cm			31.2 Lb 14.15 kg					

ACCESSORIES



REF. 18980
Maintenance Kit





TS-MAX

AUTHENTIC & ORIGINAL: LIGHTWEIGHT AND FUNCTIONAL WITH HIGH PERFORMANCE BREAKER.

For professional cutting of porcelain tiles and ceramic tiles.



Category

SUPERPRO

Use

PROFESSIONAL

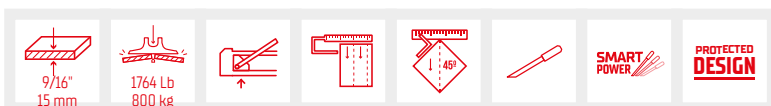
Material

STONEWARE

SINGLE POINT



- **Progressive breaking system "SMART POWER" adapts to different material hardness.**
- **Wide base. Greater base surface for higher stability and cutting quality.**
- **Reinforced components for heavy duty work. High durability.**
- **Ergonomic handles. Maximum comfort.**
- Bigger reinforced base for a higher comfort and better stability when cutting.
- Powerful single point breaker. Up to 800 kg breaking pressure.
- Double guide for direct view of scoring/cutting line.
- Chromed steel guides, rectified and calibrated, with anti-rust treatment.
- Lateral stop for repetitive straight and 45° cuts.
- Interchangeable scoring wheels ranging from Ø 6mm to 22 mm.
- Includes Ø 8mm ENDURE and Ø 10 mm SILVER scoring wheels and a transport case with reinforced locks and hinges.



	REF.									
TS-43 MAX	18920	√	16 15/16" 43 cm	12x12" 30x30 cm	1/4-9/16" 6-15 mm	1764 Lb 800 kg	19.4 Lb 8.8 kg	1	24	
TS-57 MAX	18921		22 7/16" 57 cm	16x16" 40x40 cm			21.8 Lb 9.9 kg			
TS-66 MAX	18922		26" 66 cm	18 1/8x18 1/8" 46x46 cm			29.5 Lb 13.4 kg		20	
TS-75 MAX	18923		29 1/2" 75 cm	20 7/8x20 7/8" 53x53 cm			33.3 Lb 15.1 kg			
TS-43 MAX (GREY)	18972		16 15/16" 43 cm	12x12" 30x30 cm			19.4 Lb 8.8 kg		24	
TS-66 MAX (GREY)	18974		26" 66 cm	18 1/8x18 1/8" 46x46 cm			29.5 Lb 13.4 kg			
TS-75 MAX (GREY)	18975		29 1/2" 75 cm	20 7/8x20 7/8" 53x53 cm			33.3 Lb 15.1 kg		20	

ACCESSORIES



REF. 18980
Maintenance Kit

SPEED-MAGNET

FOR THE MOST DEMANDING TILING PROJECTS.

For professional cutting of porcelain tiles and ceramic tiles.

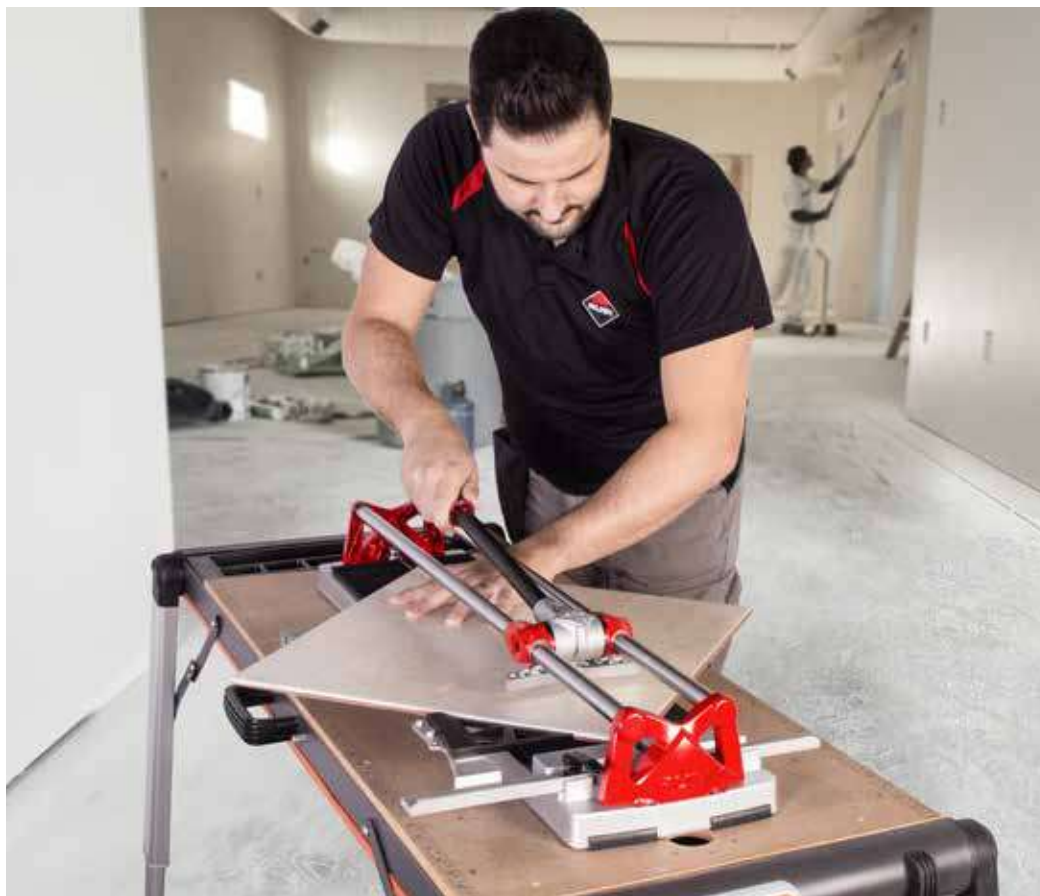

Category

SUPERPRO

Use

●●○

PROFESSIONAL

Material

STONEWARE

LIGHT

- **Quick speed system with magnet, ideal for one-handed use. Easy and fast to use.**
- **Great visibility during scoring.**
- **Reinforced structured elements. High breaking power.**
- **Aluminum base for robustness. Light and easy to transport.**
- Solid 20mm steel guides. Chromed and rectified with anti-corrosion treatment for greater resistance to twisting.
- Multipoint breaker 800kg power.
- Reinforced SOFT-GRIP handle.
- Lateral stop for repetitive cuts and 45 degrees square.
- Interchangeable scoring wheels ranging between Ø 6mm–22mm.
- Scoring wheel Ø 8mm ENDURE. included.
- Direct view of scoring and cutting line.
- 72/92 models:
 - Aluminum lateral support.



	REF.										
SPEED-62 MAGNET WITH CASE	14988	✓	24 7/16" 62 cm	17 5/16x17 5/16" 44x44 cm	1/8-9/16" 3-15 mm	1764 Lb 800 kg	18 Lb 8 kg	254 Lb 115 kg	2	24	
SPEED-72 MAGNET WITH CASE	14989		28 3/8" 72 cm	20 1/16x20 1/16" 51x51 cm			20.9 Lb 9.5 kg	30 Lb 13.6 kg		1	18
SPEED-92 MAGNET WITH CASE	14990		36 1/4" 92 cm	25 9/16x25 9/16" 65x65 cm			26 Lb 12 kg	37 Lb 16.8 kg			
SPEED-62 MAGNET	14980	-	24 7/16" 62 cm	17 5/16x17 5/16" 44x44 cm			18 Lb 8 kg	0 Lb - kg	1	2	30
SPEED-72 MAGNET	14981		28 3/8" 72 cm	20 1/16x20 1/16" 51x51 cm			20.9 Lb 9.5 kg			35	
SPEED-92 MAGNET	14982		36 1/4" 92 cm	25 9/16x25 9/16" 65x65 cm			26 Lb 12 kg			28	

ACCESSORIES



REF. 18980
Maintenance Kit





SPEED-N

THE MOST VERSATILE TILE CUTTER IN ITS RANGE.

For professional cutting of ceramic tiles, occasionally for porcelain tiles.



Category



Use



PROFESSIONAL

Material



STONEWARE



STURDINESS



- **Reinforced structured elements. High breaking power.**
 - **Chromed and rectified steel guides, with anticorrosion treatment. Higher durability.**
 - **Aluminum base for higher robustness.**
 - **Light and easy to transport.**
 - With lateral stop for repetitive cuts and 45 degree squares.
 - Interchangeable scoring wheels ranging between Ø 6mm to 10mm.
 - Scoring wheel Ø 8 mm SILVER included.
 - Direct vision of scoring and cutting line.
- 72/92 models;
-Aluminum lateral support.



	REF.								
SPEED-62 N WITH CASE	14985	√	24 7/16" 62 cm	17 5/16x17 5/16" 44x44 cm	3/16-9/16" 5-15 mm	15 Lb 7 kg	23.4 Lb 10.6 kg	2	24
SPEED-72 N WITH CASE	14986		28 3/8" 72 cm	20 1/16x20 1/16" 51x51 cm		18.1 Lb 8.2 kg	27.6 Lb 12.5 kg		18
SPEED-92 N WITH CASE	14987		36 1/4" 92 cm	25 9/16x25 9/16" 65x65 cm		24 Lb 11 kg	35.1 Lb 15.9 kg	1	
SPEED-62 N	14975	-	24 7/16" 62 cm	17 5/16x17 5/16" 44x44 cm		15 Lb 7 kg	23.4 Lb 10.6 kg	2	30
SPEED-72 N	14976		28 3/8" 72 cm	20 1/16x20 1/16" 51x51 cm		18.1 Lb 8.2 kg	27.6 Lb 12.5 kg	1	40
SPEED-92 N	14977		36 1/4" 92 cm	25 9/16x25 9/16" 65x65 cm		24 Lb 11 kg	35.1 Lb 15.9 kg		28

ACCESSORIES



REF. 18980
Maintenance Kit



FAST

LIGHT AND VERSATILE CUTTER.

For professional cutting of ceramic tiles.



Category



Use



PROFESSIONAL

Material



STONEWARE

VERSATILITY

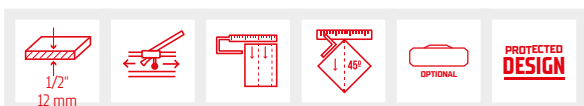

- **Extruded aluminum base.**
- **New rigid and stable separator.**
- **Reinforced 18mm guides for greater resilience.**
- **Four side brackets for a great additional support.**
- Wider foam base.
- Chromed steel guides with anti-rust treatment.
- Lateral stop with 45° square.
- Base for greater support of the tile.
- Interchangeable scoring wheels from Ø1/4" (6mm) to 3/8" (10mm).
- Ø1/4" (6mm) SILVER scoring wheel included.
- Two-layer base with shock absorption.
- Direct view of the scoring and cutting line.



	REF.								
FAST-85 WITH BAG	13939	√	33 7/16" 85 cm	24x24" 60x60 cm	1/2" 12 mm	16.5 Lb 7.5 kg	18.7 Lb 8.5 kg	2	32
FAST-65	13940	-	25 9/16" 65 cm	17 11/16x17 11/16" 45x45 cm		13.9 Lb 6.3 kg	0 Lb - kg	4	48
FAST-85	13941	-	33 7/16" 85 cm	24x24" 60x60 cm		16.5 Lb 7.5 kg	- kg	2	32

ACCESSORIES



REF. 18980
Maintenance Kit





STAR PLATINUM

LIGHT AND VERSATILE MANUAL CUTTER.

For professional cutting of ceramic tiles, occasionally for porcelain tiles.



Category



PRO

Use



PROFESSIONAL

Material



STONEWARE



LIGHT



- **Multipoint breaker with aluminium pressure pad and steel breaker bar for greater ROBUSTNESS and breaking POWER.**
- **Aluminium tool holder, more RIGID and STABLE for EASIER tile scoring.**
- **Cast aluminium base, LIGHT and STRONG with side extensions for large pieces.**
- **Cast ALUMINIUM guide supports for greater ROBUSTNESS.**
- Dual guide for greater VISIBILITY of the scoring and cutting line.
- Solid, chromed, ground and calibrated steel guides with anti-corrosion treatment.
- Side stop with millimetre scale and 45° square.
- Interchangeable scoring wheels from Ø1/4"(6mm) to 3/8" (10mm).
- Ø 6 mm SILVER scoring wheel included.



	REF.								
STAR-63 PLATINUM WITH CASE	15904	✓	24 13/16" 63 cm	17 11/16" 45X45 cm		9.68 Lb 4.39 kg	13.32 Lb 6.04 kg	4	
STAR-51 PLATINUM	15901		20 1/16" 51 cm	14 3/16" 36X36 cm	1/2" 12 mm	8.29 Lb 3.76 kg		6	1
STAR-63 PLATINUM	15902		24 13/16" 63 cm	17 11/16" 45X45 cm		9.68 Lb 4.39 kg			

ACCESSORIES



REF. 18980
Maintenance Kit





STAR

LIGHT AND VERSATILE CUTTER.

For occasional cutting of ceramic tile and cutting of porcelain tiles.



Category



Use



OCCASIONAL

Material



STONEWARE



RELIABILITY



PROTECTED DESIGN

- **Closed sliding mobile breaker for greater bending strength.**
- **New support reinforced for durability and power separation.**
- **Chromed steel guides with anti-rust treatment for greater durability.**
- **Base for correct support of the tile.**
- Interchangeable scoring wheels from Ø1/4" (6mm) to 3/8" (10mm).
- Ø1/4" (6mm) SILVER scoring wheel included.
- Two-layer base with shock absorption.
- Direct view of the scoring and cutting line.



	REF.								
STAR-42 WITH CASE	14946	√	16 9/16" 42 cm	12x12" 30x30 cm	1/2" 12 mm	7.5 Lb 3.4 kg	10.6 Lb 4.8 kg	4	48
STAR-51 WITH CASE	14947		20 1/16" 51 cm	14 3/16x14 3/16" 36x36 cm		8.2 Lb 3.7 kg	12.3 Lb 5.6 kg		
STAR-63 WITH CASE	14948		24 13/16" 63 cm	17 11/16x17 11/16" 45x45 cm		9.5 Lb 4.3 kg	14.3 Lb 6.5 kg		
STAR-42	14943		16 9/16" 42 cm	12x12" 30x30 cm		7.5 Lb 3.4 kg	0 Lb - kg	6	72
STAR-51	14944		20 1/16" 51 cm	14 3/16x14 3/16" 36x36 cm		8.2 Lb 3.7 kg			
STAR-63	14945		24 13/16" 63 cm	17 11/16x17 11/16" 45x45 cm		9.5 Lb 4.3 kg			

ACCESSORIES



REF. 18980
Maintenance Kit





PRACTIC

IDEAL FOR SMALL RENOVATIONS AND LIGHT WORK.
For occasional cutting ceramic wall and floor tiles.



Category
PRO

Use
●○○
OCCASIONAL

Material

STONEWARE

LIGHT

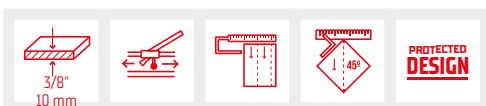

- **Movable breaker, ideal for diagonal cuts.**
- **Aluminium guide supports for greater rigidity.**
- **Lateral end stop for repetitive cuts.**
- **Interchangeable scoring wheels to adapt to each material.**
- Chromed steel guides and aluminium support.
- Mobile breaker with Ø1/4"(6mm) SILVER scoring wheel included.
- Interchangeable scoring wheels Ø1/4"(6mm) to 3/8"(10mm) for cutting different materials.

	REF.						
PRACTIC-51	24984	20 1/16" 51 cm	14 3/16x14 3/16" 36x36 cm	3/8" 10 mm	6.4 Lb 2.9 kg	6	72
PRACTIC-61	24985	24 1/16" 61 cm	16 15/16x16 15/16" 43x43 cm		10.8 Lb 4.9 kg		

ACCESSORIES

REF. 18980
Maintenance Kit



BASIC

IDEAL FOR SMALL RENOVATIONS AND LIGHT WORK.
For occasional cutting ceramic floor tiles.



Category
PRO

Use
●○○
OCCASIONAL

Material

CERAMIC TILE

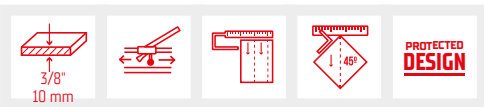

- Base, guide & supports in steel and aluminium.
- Mobile breaker and Ø9/16"(14mm) SILVER Tungsten Carbide scoring wheel included.
- Also comes with lateral stop and 45° square.

	REF.						
BASIC-60	25956	24 1/16" 61 cm	16 15/16x16 15/16" 43x43 cm	3/8" 10 mm	7.7 Lb 3.5 kg	6	72





ACCESSORIES

REF. 18980
Maintenance Kit

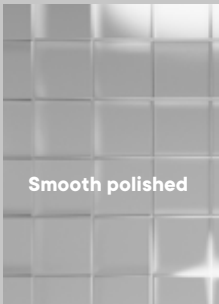

SCORING WHEELS

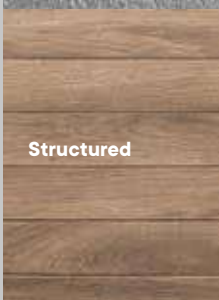

TILE SURFACE	TILE TYPE			
	CERAMIC WALL Bill	CERAMIC FLOOR BIIa - BIIb	PORCELAIN Bla	QUARRY AI - Alla - Allb - AllI
 <p>Smooth polished</p>	6 mm • ¼" Silver* 8 mm • ⅝" Silver/Endure 10 mm • ¾" Silver/Gold 18 mm • ¾" Silver		6 mm • ¼" Silver 8 mm • ⅝" Silver/Endure* 10 mm • ¾" Silver/Gold 18 mm • ¾" Silver	
 <p>Smooth Matt</p>	6 mm • ¼" Silver* 8 mm • ⅝" Silver/Endure 10 mm • ¾" Silver/Gold 18 mm • ¾" Silver 22 mm • ⅞" Silver/Extreme	6 mm • ¼" Silver 8 mm • ⅝" Silver/Endure 10 mm • ¾" Silver/Gold* 18 mm • ¾" Silver 22 mm • ⅞" Silver/Extreme	6 mm • ¼" Silver 8 mm • ⅝" Silver/Endure* 10 mm • ¾" Silver/Gold 18 mm • ¾" Silver 22 mm • ⅞" Silver/Extreme	8 mm • ⅝" Silver/Endure 10 mm • ¾" Silver/Gold 18 mm • ¾" Silver* 22 mm • ⅞" Silver/Extreme
 <p>Textured</p>	8 mm • ⅝" Silver/Endure* 18 mm • ¾" Silver 22 mm • ⅞" Silver/Extreme	8 mm • ⅝" Silver/Endure 18 mm • ¾" Silver* 22 mm • ⅞" Silver/Extreme	8 mm • ⅝" Silver/Endure 18 mm • ¾" Silver* 22 mm • ⅞" Silver/Extreme	18 mm • ¾" Silver* 22 mm • ⅞" Extreme
 <p>Highly textured</p>	8 mm • ⅝" Endure 18 mm • ¾" Silver 22 mm • ⅞" Extreme*	8 mm • ⅝" Endure 18 mm • ¾" Silver 22 mm • ⅞" Extreme*	8 mm • ⅝" Endure 18 mm • ¾" Silver 22 mm • ⅞" Extreme*	18 mm • ¾" Silver 22 mm • ⅞" Extreme*
 <p>Structured</p>	8 mm • ⅝" Endure 18 mm • ¾" Silver 22 mm • ⅞" Extreme*	8 mm • ⅝" Endure 18 mm • ¾" Silver 22 mm • ⅞" Extreme*	8 mm • ⅝" Endure 18 mm • ¾" Silver 22 mm • ⅞" Extreme*	18 mm • ¾" Silver 22 mm • ⅞" Extreme*

* Recommended



		△ PRO							△ SUPERPRO				△ PREMIUM			
		SILVER							GOLD	ENDURE			EXTREME			
Refs:		1945	1958	1959	1946	1991	1960	1950	1992	1949	1993	1906	1903	1901	1907	1900
Ø mm:		6	8	8	10	10	14	18	18	10	10	8	8	22	22	22
Ø inch:		¼	⅜	⅜	⅜	⅜	⅜	¾	¾	⅜	⅜	⅝	⅝	⅞	⅞	⅞
				PLUS		PLUS			PLUS		PLUS		PLUS			PLUS
△ PREMIUM	●●● Intensive			○		○			○		○		○			○
				○		○			○		○		○			○
△ SUPERPRO	●●● Professional													○		
		○	○		○				○		○				○	
		○	○		○				○		○				○	
		○	○		○				○		○				○	
		○	○		○				○		○				○	
		○	○		○				○		○				○	
		○	○		○				○		○				○	
		○	○		○				○		○				○	
△ PRO	●●● Occasional	○	○		○					○		○				
		○	○		○					○		○				
		○	○		○					○		○				
		○	○		○					○		○				
		○	○		○					○		○				
									○							○

■ Included

PREMIUM SCORING WHEELS

• PLUS SCORING WHEELS FOR TZ & TX-MAX PROFESSIONAL CUTTERS.

**NEW
PATENT
NEW
GEOMETRY**

2
Cut & Drill

PRO

SILVER

8MM PLUS SILVER SCORING WHEEL (Ø5/16")

- For ceramic wall, ceramic floor, porcelain and rustic ceramic floor, ideal for smooth and slightly textured surfaces.
- Tungsten carbide scoring wheel of high resistance and duration.
- Shaft made with a patented geometry for a maximum precision and minimum vibration.



REF.



8MM PLUS SILVER SCORING WHEEL (Ø5/16")

01959

10

3600

SUPERPRO

ENDURE

8MM PLUS SCORING WHEEL (Ø5/16") ENDURE

- For ceramic wall, ceramic floor, porcelain and rustic ceramic floor, ideal for smooth, textured and Highly textured surfaces.
- Wheel made of tungsten carbide.
- Patented geometry shaft, for maximum precision and minimum vibration.
- Extra-long life.



REF.



8MM PLUS SCORING WHEEL (Ø5/16") ENDURE

01903

10

PRO

SILVER

10MM PLUS SILVER SCORING WHEEL (Ø3/8")

- For ceramic wall, ceramic floor, porcelain and rustic ceramic floor, ideal for smooth and slightly textured surfaces.
- Tungsten carbide scoring wheel of high resistance and duration.
- Shaft made with a patented geometry for a maximum precision and minimum vibration.



REF.



10MM PLUS SILVER SCORING WHEEL (Ø3/8")

01991

10

3600

SUPERPRO

GOLD

10MM PLUS GOLD SCORING WHEEL (Ø13/32")

- For ceramic wall, ceramic floor, porcelain and rustic ceramic floor, ideal for non-slip surfaces.
- Tungsten carbide scoring wheel with a superficial titanium treatment.
- Shaft made with a patented geometry for a maximum precision and minimum vibration.
- Long-lasting.



REF.



10MM PLUS GOLD SCORING WHEEL
(Ø13/32")

01993

10

3600

PRO

SILVER

18MM PLUS SILVER SCORING WHEEL (Ø3/4")

- For ceramic wall, ceramic floor, porcelain and rustic ceramic floor, ideal for Highly textured.
- Tungsten carbide scoring wheel of high resistance and duration.
- Shaft made with a patented geometry for a maximum precision and minimum vibration.



REF.



18MM PLUS SILVER SCORING WHEEL (Ø3/4")

01992

10

3600

 PREMIUM

EXTREME

22MM SCORING WHEEL PLUS EXTREME(Ø 7/8")

- For ceramic walls, ceramic floor, porcelain and rustic ceramic floor, ideal for Highly textured and structured surfaces.
- Tungsten carbide scoring wheel with a superficial titanium treatment.
- Mounted on bearing. Enhanced smooth user perception.
- Extra-long life.



REF.



22MM SCORING WHEEL PLUS EXTREME (Ø 7/8")

01900

10

-

SUPERPRO SCORING WHEELS

- ADAPTABLE SCORING WHEEL FOR TP & TQ PROFESSIONAL CUTTERS.

 PREMIUM

EXTREME

22MM SCORING WHEEL PLUS EXTREME (Ø 7/8") TP/TQ

- For sharp cuttings in hard ceramic and porcelain tiles.
- Tungsten Carbide scoring wheel with a superficial Titanium treatment.
- Mounted on bearing. Enhanced smooth user perception.
- Extra-long life.



REF.

22MM SCORING WHEEL PLUS EXTREME (Ø 7/8")
TP/TQ

01901

5



SUPERPRO SCORING WHEELS

• FOR TR-MAGNET, HIT-PLUS, HIT-N, TS-MAX AND SPEED-MAGNET CUTTERS.

**NEW
PATENT
NEW
GEOMETRY**

2
Cut & Drill

PRO

SILVER



6MM SILVER SCORING WHEEL (Ø1/4")

- For ceramic wall, ceramic floor and porcelain, ideal for tiles with smooth and slightly textured surfaces.
- Tungsten carbide scoring wheel of high resistance and durability.
- Lock system patented model with new high technology RUBI® alloy; maximum precision and resistant to wear.

REF.



SCORING WHEEL Ø1/4" (6MM) SILVER

01945

10

4600

PRO

SILVER



8MM SILVER SCORING WHEEL (Ø5/16")

- For ceramic wall, ceramic floor, porcelain and rustic ceramic floor, ideal for smooth and slightly textured surfaces.
- Tungsten carbide scoring wheel of high resistance and durability.
- Lock system patented model with new high technology RUBI® alloy; maximum precision and resistant to wear.

REF.



SCORING WHEEL Ø5/16" (8MM) SILVER

01958

10

4600

SUPERPRO

ENDURE



8MM ENDURE SCORING WHEEL (Ø5/16")

- For ceramic wall, ceramic floor, porcelain and rustic ceramic floor, ideal for smooth, textured and Highly textured surfaces.
- Wheel made of tungsten carbide.
- Lock system patented geometry shaft, for maximum precision and minimum vibration.
- Extra-long life.

REF.



SCORING WHEEL Ø5/16" (8MM)
ENDURE

01906

5

PRO

SILVER



10MM SILVER SCORING WHEEL (Ø3/8")

- For ceramic wall, ceramic floor, porcelain and rustic ceramic floor, ideal for smooth and slightly textured surfaces.
- Tungsten carbide scoring wheel of high resistance and durability.
- Lock system patented handle made with new high technology RUBI® alloy; maximum precision and resistant to wear.

REF.



SCORING WHEEL Ø3/8" (10MM) SILVER

01946

10

4600

SUPERPRO

GOLD



10MM GOLD SCORING WHEEL (Ø3/8")

- For ceramic wall, ceramic floor, porcelain and rustic ceramic floor, ideal for non-slip surfaces.
- Tungsten carbide scoring wheel with a superficial titanium treatment.
- Lock system patented handle made with new high technology RUBI® alloy; maximum precision and resistant to wear. Long-lasting.

REF.



SCORING WHEEL Ø3/8" (10MM) GOLD

01949

10

4600



PRO

SILVER

18MM SILVER SCORING WHEEL (Ø3/4")

- For ceramic wall, ceramic floor, porcelain and rustic ceramic floor, ideal for Highly textured.
- Tungsten carbide scoring wheel of high resistance and durability.
- Lock system patented shaft geometry; maximum precision and minimum vibration.
- Compatible with FAST cutters.



REF.



SCORING WHEEL Ø3/4" (18MM) SILVER

01950

10

3600

PREMIUM

EXTREME

22MM SCORING WHEEL (Ø7/8") EXTREME

- For ceramic walls, ceramic floor, porcelain and rustic ceramic floor, ideal for Highly textured and structured surfaces.
- Tungsten carbide scoring wheel with a superficial titanium treatment.
- Patented lock system geometry shaft, for maximum precision and minimum vibration.
- Patented model for maximum precision and minimum vibration.
- Extra-long life.



REF.



SCORING WHEEL Ø7/8" (22MM) EXTREME

01907

5

PRO

SILVER

6MM SILVER SCORING WHEEL SET (Ø1/4")

- Tungsten carbide scoring wheel of high resistance and durability.
- Shaft made with a patented geometry for a maximum precision and minimum vibration.
- Shaft made patented lock system with new high technology RUBI® alloy; maximum precision and resistant to wear.



REF.



2 SCORING WHEEL Ø1/4" (6MM) SET SILVER

01947

10

3600

PRO

SILVER

6MM (Ø1/4") & 10MM (Ø3/8") SCORING WHEELS SET

- Tungsten carbide scoring wheel of high resistance and durability.
- Shaft made patented lock system with new high technology RUBI® alloy; maximum precision and resistant to wear.



REF.



Ø1/4" (6MM) & Ø3/8" (10MM) SCORING WHEELS SET

01948

10

3600



SCORING WHEEL SETS

- SETS OF SCORING WHEELS OF DIFFERENT DIAMETERS WITH BOX.



PRO

SILVER

SCORING WHEEL SET 2



- For TS-MAX, TR-MAGNET, TF-MAX & SPEED-MAGNET models, includes 1 scoring wheel of $\text{Ø}1/4"$ (6mm).
- $\text{Ø}5/16"$ (8mm), $\text{Ø}3/8"$ (10mm), $\text{Ø}7/8"$ (18mm) (2 units) SILVER.
- In plastic box with transparent cover.
- Supplied in blister.

	REF.		
SCORING WHEEL SET 2	01996	5	450

PRO SCORING WHEELS

- SELECTION OF SCORING WHEELS FOR SPEED-N, FAST, STAR-PLATINUM, STAR & PRACTIC MANUAL CUTTERS.

**NEW
PATENT
NEW
GEOMETRY**



PRO

SILVER

6MM SILVER SCORING WHEEL ($\text{Ø}1/4"$)



- For ceramic wall, ceramic floor and porcelain, ideal for tiles with smooth and slightly textured surfaces.
- Wheel made from tungsten carbide of high resistance and duration.
- Patented model with new high technology RUBI® alloy, maximum precision and resistant to wear.

	REF.		
6MM SCORING WHEEL ($\text{Ø}1/4"$) SILVER	01945	10	4600

PRO

SILVER

8MM SILVER SCORING WHEEL ($\text{Ø}5/16"$)



- For ceramic wall, ceramic floor, porcelain and rustic ceramic floor, ideal for smooth and slightly textured surfaces.
- Wheel made from tungsten carbide of high resistance and duration.
- Patented model with new high technology RUBI® alloy, maximum precision and resistant to wear.

	REF.		
8MM SCORING WHEEL ($\text{Ø}5/16"$) SILVER	01958	10	4600

 SUPERPRO

ENDURE

8MM SCORING WHEEL (Ø5/16") ENDURE

- For ceramic wall, ceramic floor, porcelain and rustic ceramic floor, ideal for smooth, textured and Highly textured surfaces.
- Wheel made of tungsten carbide.
- Patented geometry shaft, for maximum precision and minimum vibration.
- Extra-long life.



REF.



8MM SCORING WHEEL (Ø5/16") ENDURE

01906

5

 PRO

SILVER

10MM SILVER SCORING WHEEL (Ø3/8")

- For ceramic wall, ceramic floor, porcelain and rustic ceramic floor, ideal for smooth and slightly textured surfaces.
- Wheel made in tungsten carbide of high resistance and duration.
- Shaft made with new high technology RUBI® alloy, maximum precision and minimum vibration.



REF.



10MM SCORING WHEEL (Ø3/8") SILVER

01946

10

4600

 PRO

SILVER

6MM SILVER SCORING WHEEL SET (Ø 1/4")

- For ceramic wall, ceramic floor and porcelain, ideal for tiles with smooth and slightly textured surfaces.
- Handle made with a patented geometry for a maximum precision and minimum vibration.
- Patented model with new high technology RUBI® alloy; maximum precision and resistant to wear.



REF.



6MM SCORING WHEEL SET (Ø 1/4") SILVER

01947

10

3600

 PRO

SILVER

6MM SILVER(Ø1/4") & 10MM (Ø3/8") SILVER SCORING WHEELS SET

- For ceramic wall, ceramic floor and porcelain, ideal for tiles with smooth and slightly textured surfaces.
- Tungsten Carbide scoring wheel of high resistance and duration.
- Handle made with new high technology RUBI® alloy; maximum precision and resistant to wear.



REF.



6MM (Ø1/4") & 10MM (Ø3/8") SILVER SCORING WHEELS SET

01948

10

3600

 PRO

SILVER

14MM SILVER SCORING WHEEL (Ø9/16")

- For BASIC, KIT and TEN-BRIC tile cutters.
- Wheel made of Tungsten Carbide.



REF.



14MM SILVER SCORING WHEEL (Ø9/16")

01960

10

4600

ACCESSORIES FOR MANUAL TILE CUTTERS

• LATERAL STOPS FOR MANUAL CUTTERS.



◆ SUPERPRO



MAINTENANCE KIT

- Cleaning, lubricating & maintenance oil suitable for regular maintaining of cutter parts that are regularly used; guides, sliding system, tilted axes, spiral, metallic surfaces.

	REF.		
MAINTENANCE KIT	18980	8	640

NIPPERS

• WIDE RANGE OF PLIERS FOR CUTTING CERAMICS, PORCELAIN & GLASS.



◆ SUPERPRO



NIPPERS FOR PORCELAIN TILES

- Specially for cutting narrow strips of a maximum of 7/16" (1 cm). Equipped with tungsten carbide GOLD scoring wheels with titanium surface treatment for longer useful life. By means of a gentle turn, the wheels can be repositioned when their vertex starts getting worn. If totally worn, they can be replaced using their corresponding spare piece, Ø 3/4" (18 mm) GOLD spare scoring wheel long-life (Ref.01953).

	REF.		
NIPPERS FOR PORCELAIN	83942	5	765

◆ SUPERPRO



TILER NIPPERS

- Tungsten Carbide Pliers.
- Ideal for rectification of holes in ceramics.
- Bi-material handle Ergonomic.

	REF.		
PARROT NIPPER - CARBIDE	65925	5	765

**NIPPERS FOR CERAMIC TILES**

- Tungsten Carbide Edge.
- Ideal for the rectification of straight cut on ceramics.
- Bi-material handle Ergonomic.

REF.



NIPPERS FOR CERAMIC TILES

65926

6

**NIPPERS FOR GLASS MOSAIC**

- Tungsten Carbide Edge.
- Ideal for the rectification of glass mosaic tiles.
- Bi-material handle Ergonomic.

REF.



NIPPERS FOR MOSAIC

71970

5

MANUAL CUTTERS FOR BUILDING MATERIALS

- FOR DIFFERENT TYPES OF BUILDING MATERIALS.



**CELLULAR CONCRETE SAW**

- Saw with 29 Tungsten Carbide teeth.
- Length: 29" (75cm).
- Beechwood and varnished handle.

REF.



CELLULAR CONCRETE SAW

70930

2





SLAB SYSTEM

CUTTING AND HANDLING LARGE-SIZED TILE

Cutting large tile
Handling large tile
Installing large tile





SLAB CUTTER G3

MANUAL CUTTING SYSTEM WITH CONNECTABLE GUIDES.

For manual cutting of large porcelain tiles.



Category



PREMIUM

Use



INTENSIVE



PRECISION

SCORING WHEEL
POWER



126"
320 cm



1/8-3/8"
3-10 mm



- **System with movable suction cups integrated in the guides. Special grey rubber suction cups for rough surfaces that won't leave marks on the tile.**
- **Carriage with lever mechanism for perfect scoring. Extreme roller guide.**
- **Highly reinforced guides. Easily interconnected by means of an adjustable lever mechanism.**
- **Transport bag with padded handles and pockets for accessories.**
- Breaking system by adjustable nippers with soft-grip handle, which facilitates and ensures progressive breaking of the tile, thus reducing the risk of cracking. 2-in-1 nippers and breaker.
- Ø 22 mm RUBI EXTREME roller guide made of Tungsten Carbide with Titanium Carbide treatment and bearings, to offer better scoring performance and quality.
- Each set contains: Three 112 cm guides, 1 marker carriage with 22 mm roller guide, 1 set of nippers and 6 suction cups.
- Transport bag with padded handles and pockets for accessories.



	REF.							
SLAB CUTTER G3	16900	√	126" 320 cm	1/8-3/8" 3-10 mm	24 Lb 11 kg	35.7 Lb 16.2 kg	1	-

The Slab Breaker Plus [ref. 18917] must be used for thicknesses from 10 mm to 20 mm.

ACCESSORIES		REF. 18917 Slab Breaker Plus		REF. 16908 Slab Cutter G3 Supplement Guide and Suction Cups		REF. 54918 Slab breaker pliers
-------------	--	---------------------------------	--	--	--	-----------------------------------



SLIM CUTTER G2

HAND CUTTING SYSTEM WITH CONNECTABLE GUIDES.

For hand cutting of large porcelain tiles with thicknesses between 3 and 10 mm.



Category



SUPERPRO

Use



PROFESSIONAL



PRECISION



LIGHT



- **High-scoring power thanks to the new tilting carriage design and its fixing on the reinforced guides.**
- **Maximum 360 cm cutting capacity (extendable) thanks to its connectable guides. Allows a 120 cm cut with a single guide.**
- **Excellent fixing of the guides on the tile by means of 3 natural rubber suction cups, suitable for rough surfaces, with double anchoring point.**
- **It prevents tile breakage by means of the progressive breaking system of the adjustable nippers with soft-grip handle. 2-in-1 nippers and breaker.**
- Recommended thicknesses between 3 and 10 mm.
- Specially designed for large tiles, it provides a perfect cut without chipping with a light and easy-to-store cutter.
- High durability of the 22 mm RUBI EXTREME roller guide. Manufactured in tungsten carbide with tungsten carbide treatment and bearings, it offers better performance and high scoring quality.
- Easily transportable. It includes two practical reinforced transport bags with compartments, handles and a shoulder strap. These can be transported separately or together with the use of a simple connecting system.
- Each set contains: Two 155 cm guides, one 65 cm guide, 1 marker carriage with 22 mm roller guide, 1 set of nippers, 3 suction cups, 1 Allen key and 2 transport bags.



NEW!



3+2
YEARS
WARRANTY

1 2 3 4 5
Cut & Drill

	REF.						
SLIM CUTTER G2	23999	✓	141 3/4" 360 cm	3/8" 10 mm	0 Lb - kg	1	-

ACCESSORIES		REF. 27911 Slim Cutter G2 Head		REF. Slim Cutter G2 Supplement Guides		REF. TC-125 G2 circular cutter



CUTTING

2
Cut & Drill



PREMIUM

6-20 mm

POWER

SLAB BREAKER PLUS

- Auxiliary breaker for the cut of slim porcelain slabs or large tiles.
- To separate thicknesses of 6 mm up to 20 mm.
- Soft-grip handle for a better comfort and ergonomic.
- With width adjustment system, to achieve an equal, uniform and symmetric distribution of breaking forces when cutting narrow strips.
- Rubber pressure pad for greater control and more precise separation.

REF.



SLAB BREAKER PLUS

18917

1

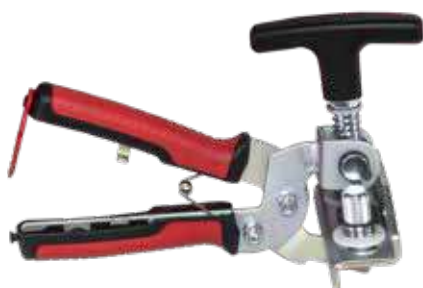

SUPERPRO

3-10 mm

FAST

SLAB BREAKER NIPPERS

- Nippers/breaker for large porcelain tiles of between 3 and 10 mm thick.
- Nippers with bi-material soft-grip handle with clip to keep the nippers closed.
- High breaking power for tiles from 3 to 10 mm thick.
- Reinforced nippers designed for greater comfort and durability.
- Can be used as nippers for thinner tiles and as a breaker if the thickness or hardness of the material requires it. 2-in-1 nippers and breaker.

REF.



SLAB BREAKER PLIERS

54918

1



NEW!

SUPERPRO

SLIM CUTTER G2 HEAD

- Tilting carriage with an ergonomic handle for the G2 cutting system.
- Improves the fixing on the guides.

REF.



SLIM CUTTER G2 HEAD

27911

1



NEW!

SUPERPRO

SLIM CUTTER G2 SUPPLEMENT GUIDES

- Aluminum guides for the G2 system.

REF.



SLIM CUTTER G2 SUPPLEMENT GUIDE 65 CM.

52948

1

SLIM CUTTER G2 SUPPLEMENT GUIDE 155 CM.

51999



PREMIUM



SLAB CUTTER G3 SUPPLEMENT GUIDE

- Extruded aluminium guide with extra 112 cm.
- Includes two suction cups integrated into the guide.

	REF.	
SLAB CUTTER G3 SUPPLEMENT GUIDE AND SUCTION CUPS	16908	1

PREMIUM



22MM SCORING WHEEL PLUS EXTREME (Ø 7/8") SLAB CUTTER

- For sharp cuttings in hard tiles with rough or structured surfaces.
- Tungsten Carbide scoring wheel with a superficial Titanium treatment.
- Mounted on bearing. Enhanced smooth user preception.
- Extra-long life.

	REF.	
22MM SCORING WHEEL PLUS EXTREME (Ø 7/8") SLAB CUTTER	01901	5

SUPERPRO



TC-125 G2 CIRCULAR CUTTER

- Accessory exclusively for users of the SLIM CUTTER G2 manual cutting system.
- Requires the use of the SLIM CUTTER G2 guides.
- Equipped with a carbon steel slide on adjustable double set stainless steel radial bearings.
- Double dust reduction/control system. Dry and wet cutting.
- Height-adjustable cutting head (saw effect), hinged from 0° to 45°. (mitre). Fast adjustment system.
- More ergonomic. Additional bi-material handle, mainly for mitre cuts.
- Includes Ø125 blade and carrying case.

	REF.			RPM	W										
TC-125 G2	51951	√		13800	1250 W	126" 320 cm	13/16-1" 20-25 mm	9/16-11/16" 14-18 mm	4 1/2-5" 115-125 mm	7/8" 22.2 mm	14 3/16x9 5/8x8 1/4" 36x24.5x21 cm	31 Lb 14 kg	1		
TC-125 G2 UK	51967														
	51977														
TC-125 G2 USA	51987														

TC-125 G2 CIRCULAR CUTTER KIT

CIRCULAR CUTTER, SMOOTH AND PRECISE, IDEAL LARGE FORMAT TILES.

For cutting ceramic and porcelain tiles. Suitable for use with natural and synthetic stone. Especially suitable for large format tiles.



Category

SUPERPRO

Use

PROFESSIONAL

MITRE CUT
DRY AND WET CUT126"
320 cm13/16-1"
20-25 mm**PROTECTED
DESIGN**

- Includes a set of suction cups suitable for all surfaces for fixing the guide to the part.
- Equipped with a carbon steel slide on adjustable double set stainless steel radial bearings.
- Double dust reduction/control system. Dry and wet cutting.
- Height-adjustable cutting head (saw effect), hinged from 0° to 45°. (mitre). FAST adjustment system.
- More ergonomic. Additional BI-MATERIAL handle, mainly for mitre cuts.
- Compatible with discs of 125 or 115 mm diameter. (Suitable for discs with reinforcement plate, TVA type).
- Switch with SAFETY lock. Prevents UNINTENTIONAL start-up. Electrical cable with PRCD.
- Direct connection to vacuum cleaner. Includes adapter for other models and brands (37, 42 and 50 mm diameter).
- Quick connection and regulating valve for hose (16 mm diameter). Rubber stopper for suction outlet. IMPROVES ergonomics during wet cutting.
- Cast aluminium disc protector with transparent polycarbonate cover with quick opening and closing system. FACILITATES disc change and MINIMISES the projection of particles and water.
- Tilting side guard for mitre cuts. REDUCES water splashing and IMPROVES dust suction.
- Each set contains: 2 155 cm guides, 1 65 cm guide, 1 TC-125 cutter, 1 Ø125 disc, 2 fixing suction cups, 2 clamps, 2 spacers, 1 vacuum cleaner adapter, 1 carry case and 1 carrying bag. FACILITATES transport and handling.



NEW!



3+1
YEARS WARRANTY

1 2 3 4 5
Cut & Drill

	REF.			RPM	W									
TC-125 G2 230V 50/60HZ	51951	√	220-240V 50-60Hz	13800	1250 W	126" 320 cm	13/16-1" 20-25 mm	9/16-11/16" 14-18 mm	4 1/2-5" 115-125 mm	7/8" 22.2 mm	14 3/16x9 5/8x8 1/4" 36x24.5x21 cm	31 Lb 14 kg	1	-
TC-125 G2 230V 50/60HZ UK	51967													
TC-125 G2 110V 50/60HZ UK	51977		110-130V 50-60Hz											
TC-125 G2 120V 50/60HZ USA	51987													
GUIAS KIT TC-125 G2	51949													

The kit is a cutter reference plus the guide reference [Ref.51949]. It must be used with the SLIM SYSTEM G2 guides.

ACCESSORIES		Description	REF.		Description	REF.		Description
		Slim Cutter G2 Supplement Guides	27911		Slim Cutter G2 Head	54918		Slab breaker pliers
						18934		Slab Trolley

SLAB TRANS HEAVY DUTY N

FULLY ADJUSTABLE FRAMEWORK FOR HANDLING LARGE FORMAT LARGE FORMAT CERAMIC, PORCELAIN AND NATURAL STONE SLABS.

Especially suited for handling thicker sheet tiles.



Category



PREMIUM

Use



INTENSIVE



HIGH LOAD CAPACITY



SECURITY



- **Reinforced aluminium profile joined by a system of sliders. Greater structural strength.**
- **Includes 2 perpendicular aluminium guides, for greater stiffness.**
- **Equipped with four retractable and removable Soft-Grip handles to adapt to every situation during installation. Six light coloured vacuum suction cups that do not leave marks on the tile. Increased load capacity.**
- **Fast and easy to assemble and disassemble. Easy fix system.**
- Black anodized finish.
- Maximum load capacity: 170 kg.
- Dimensions: 3800x1700x237 mm. (assembled and deployed).
- Maximum handling size: 360 x 160 cm.
- Unitary box with RUBI's flexography and full-colour label.



	REF.				
SLAB TRANS HEAVY DUTY N	18982	149 5/8x66 15/16x9 5/16" 380x170x23.7 cm	78 Lb 35.4 kg	1	1

Additional vacuum suction cups available can be attached to the system but it does not increase the maximum load capacity of 170 kg.

ACCESSORIES		REF. 18979 Vacuum suction pad SLAB TRANS HEAVY DUTY N		REF. 21955 supplementary vacuum suction cup for guide set		REF. 18934 Slab Trolley
-------------	--	--	--	--	--	----------------------------





SLIM EASY TRANS PLUS

FOR TRANSPORTING OF LARGE-FORMAT SHEET TILES.



Category
SUPERPRO

Use
●●○
PROFESSIONAL

RELIABILITY

SECURITY



- Includes 2 retractable and adjustable guides of 170 to 320 cm of reinforced aluminium and six 20 cm suction cups (ref. 18827) with high load capacity. Provide added safety and reliability.
- The optimal recommended gripping distance is 700 mm (distance between handles).
- The soft-grip handles can slide and be removed through the top slot of the guides.
- Multiple position settings for the suction cups.
- Each guide is suitable for working individually, with a maximum load capacity of 40kg at their maximum length.
- Maximum load capacity: 80 kg.
- For workpieces with a maximum length of 3.2m.

	REF.				
SLIM EASY TRANS PLUS	18976	651 3/16x100x89 3/4" 1654x254x228 cm	53 Lb 24 kg	1	1

Adding more suction cups does not increase the load capacity.

ACCESSORIES		REF. 18819 Slim EASY TRANS / SLIM EASY TRANS PLUS supplementary guide set		REF. 21955 supplementary vacuum suction cup for guide set		REF. 18979 Vacuum suction pad SLAB TRANS HEAVY DUTY N



SLIM EASY TRANS

TO TRANSPORT LARGE PORCELAIN SLABS.



Category
SUPERPRO

Use
 ●○○
OCCASIONAL

TRANSPORTABLE

LIGHT



- This system can be used as a complement to the Slim cutter (Ref. 18911).
- Includes two retracting guides adjustable from 160 to 320 cm and 10 suction cups for securing rough and smooth surfaces (Ref.66929).
- Maximum load of the unit: 60 kg.
- For workpieces with a maximum length of 3 m.

	REF.			
SLIM EASY TRANS	18910	36.6 Lb 16.6 kg	1	12

For every two suction cups [Ref. 18915], the load is increased by 10kg. Up to a maximum of 110kg, using 10 suction cups.

ACCESSORIES

REF. 18819
 Slim EASY TRANS / SLIM EASY TRANS PLUS supplementary guide set



SLAB TRANS MINI

FOR TRANSPORTING CERAMIC SHEETS AND LARGE-FORMAT TILES WITH A MAXIMUM RECOMMENDED SIZE OF 150 X 150 CM.



Category
SUPERPRO

Use
●●●
PROFESSIONAL

SECURITY

LIGHT



- **Ideal for medium formats. It adds less weight to the tile conveyor assembly when transporting medium-sized formats.**
- **Retractable aluminium guide. Allows us to handle and transport tiles between 100 cm and 210 cm in size. Especially recommended for formats of up to 150 x 150 cm, 6 or 8 mm thick, used diagonally.**
- **Highly reinforced, adjustable and removable soft-grip handles. With an anti-twist and soft-grip system which ensures a better grip of the assembly.**
- **2 interchangeable Ø20 cm suction cups, can be placed at any point on the guide.**
- Suction cups with a safety indicator.
- Each suction cup, of 20 cm in diameter and with a high-load capacity, has an indicator that warns us in the event of a loss of suction.
- The suction cups have a protector to prevent damage during transport.
- With a maximum load capacity of 40 kg at their maximum length.
- Maximum load capacity: 55 kg.

	REF.				
SLAB TRANS MINI	18983	18.3 Lb 8.3 kg	24.7 Lb 11.2 kg	90 15/16x10 1/4x7" 231x26x18 cm	1

ACCESSORIES



REF. 16909
SLAB TRANS MINI
SUPPORT FOR TABLE

HANDLING

3
Set

SUPERPRO



SLIM EASY TRANS SUPPLEMENTARY GUIDE SET / SLIM EASY TRANS PLUS

- Slim Easy Trans has a set of perpendicular guides for increased stability.
- With the supplementary guide set we increase the maximum load capacity to 120kg.
- Increases the rigidity of the unit.
- Facilitates handling of the pieces.
- Fast and easy to assemble and disassemble.
- Black anodized finish.



	REF.	
SLIM EASY TRANS / SLIM EASY TRANS PLUS SUPPLEMENTARY GUIDE SET	18819	1

PREMIUM



VACUUM SUCTION PAD SLAB TRANS HEAVY DUTY N

- The suction cup addition is an accessory compatible only with SLAB TRANS HEAVY DUTY N (Ref. 18982), SLIM EASY TRANS PLUS (Ref.18976) and SLAB TRANS MINI (Ref. 18983). The suction cup can be fixed to any type of surface without leaving a mark on the part. Its use allows the suction cups to be replaced while maintaining the original maximum load capacity of the transporter at all times.

	REF.		
VACUUM SUCTION PAD SLAB TRANS HEAVY DUTY N	18979	1	1

PREMIUM



SUPPLEMENTARY VACUUM SUCTION CUP FOR GUIDE SET

- Additional suction cup to place on the crossbars in the SLAB TRANS HEAVY DUTY N (Ref.18982) and SLIM EASY TRANS PLUS (Ref.18976) + CROSSBARS SET (Ref.18819).
- Provides rigidity in the transport of very thin workpieces.
- Facilitates the transport of cut workpieces.

	REF.	
SUPPLEMENTARY VACUUM SUCTION CUP FOR GUIDE SET	21955	1

SUPERPRO



SLAB TRANS MINI SUPPORT FOR TABLE

- Solely for use with the SLAB TRANS MINI and the SLAB TABLE.
- Helps to place the workpiece on the SLAB TABLE & VERSA-TILE in the back buttering position without having to remove the conveyor.

	REF.	
SLAB TRANS MINI SUPPORT FOR TABLE	16909	1



SLAB TROLLEY

TRANSPORT AND HANDLING SYSTEM FOR LARGE-FORMAT SHEET TILES.
Especially suitable for handling thicker pieces.



Category

PREMIUM

HIGH LOAD CAPACITY

**EXCLUSIVE USE WITH
SLAB/SLIM TRANS**



- Transport system and manoeuvre for large format tiles.
- Especially suitable for thicker/heavier slabs.
- Exclusive to the SLAB TRANS HD N (Ref.18982), SLIM TRANS PLUS (Ref. 18976+18819) and SLIM EASY TRANS systems (Ref.18910+18819).
- Easy and quick to assemble and disassemble. Easy fix connection system.
- Ultra light and compact.
- Extendable support arm for greater ergonomics when loading and unloading pieces on the workbench.
- Maximum load capacity: 140 kg (including material and trans system).

	REF.				
SLAB TROLLEY	18934	46 1/16x29 5/16x6 1/2" 117x74.5x16.5 cm	33 Lb 15 kg	1	5





RHINO TROLLEY

TRANSPORT AND HANDLING SYSTEM FOR LARGE TILES.
Easy to transport due to its small size.



NEW!

Category
SUPERPRO

HIGH LOAD CAPACITY

VERSATILE



- Very manageable and good stability thanks to its 4 swivel wheels (360°). It has a safety lock on the wheels to prevent undesirable movements.
- It can be transported on any type of surface, thanks to its large 160 mm diameter wheels.
- 40 cm wide platform. It can transport tiles and boxes of up to 40 mm thickness.
- Maximum load capacity 250 kg.
- Rubber cover to protect the tiles.
- Compatible with the transporters.

	REF.				
RHINO TROLLEY	28912	35 7/16x17 1/16x10 15/16" 90x43.4x27.8 cm	22 Lb 10 kg	1	-



SLAB TABLE VERSA-TILE

WORK BENCH FOR CUTTING AND HANDLING LARGE-FORMAT CERAMIC SHEETS, SPECIFICALLY DESIGNED FOR THE SLAB RANGE OF TOOLS.



Category

PREMIUM

Use
...
INTENSIVE

STABILITY

VERSATILITY

- Thanks to the shape of the legs and its structure, the table is very stable and sturdy even in its widest position. The adjustable feet ensure this stability, even on uneven floors.
- Dimensions in working position: The table is extendable from 1100 to 1515 mm, which allows you to handle the widest formats. Its length is 1800 mm.
- Its folding legs and two side wheels make it easy to transport and store.
- Double working height: 70 and 84 cm, which means it can be adapted to different needs, allowing all types of work to be carried out.
- Maximum load capacity: 260 kg. Even the largest tiles can be loaded.
- Thanks to its two movable bars and wide T-shaped profiles, you can have a support surface that allows you to work as if on a workbench for the use of smaller tools, such as hand-held cutters, for example.

	REF.					
SLAB TABLE VERSA-TILE	18984	70 7/8x60 1/4x33 1/16" 180x153x84 cm	90 Lb 41 kg	98.3 Lb 44.6 kg	1	9

ACCESSORIES

REF. 21931
 SLAB TABLE LENGTHEN ACCESSORY

REF. 21975
 SLAB TABLE TILE LIFTING ACCESSORY (C-15)





SLAB TABLE

WORK BENCH FOR CUTTING AND HANDLING LARGE-FORMAT SHEET TILES USING THE SLAB SYSTEM RANGE OF TOOLS.



Category
SUPERPRO

Use
INTENSIVE

STABILITY

- Workbench to support the cutting and preparation of large format materials using the tools of the Slab system range.
- Extra-reinforced bars thus increasing the rigidity of the workbench.
- The structure of the table together with the levelling feet achieves a greater stability of the set.
- Assembly and disassembly fast and easy. Easy fix connection system (hammerhead screws).
- Folding legs. Equipped with security system against involuntary closing.
- Dimensions in working position: 1800x1044x700 mm.
- Dimensions in transport position: 1800x1044x198 mm.
- Working height: 70 cm.
- Maximum load capacity: 250 kg.

	REF.					
SLAB TABLE	18935	70 7/8x41 1/8x27 9/16" 180x1044x70 cm	761 Lb 345 kg	79 Lb 36 kg	1	9

ACCESSORIES

REF. 21931
SLAB TABLE LENGTHEN
ACCESSORY

REF. 21975
SLAB TABLE TILE LIFTING
ACCESSORY (C-15)





HANDLING

3
Set

PREMIUM

SLAB TABLE LENGTHEN ACCESSORY



- Accessory for the SLAB VERSA-TILE TABLE, it allows you to extend the table up to 3 m while maintaining its basic features.
- Also compatible with the SLAB TABLE.

REF.



SLAB TABLE LENGTHEN ACCESSORY	21931	1
-------------------------------	-------	---

PREMIUM

SLAB TABLE TILE LIFTING ACCESSORY (C-15)



- Makes it possible to lift the workpiece 4.5 cm from the SLAB TABLE/SLAB VERSA-TILE TABLE profiles (only "T" profiles).
- Ideal for all types of cross-cutting and drilling on the table without the risk of damaging the profiles.

REF.



SLAB TABLE TILE LIFTING ACCESSORY (C-15)	21975	1
--	-------	---





RUBI TRILLER

COMPACT MANUAL VIBRATOR.

Especially designed for vibrating large format tiles.



Category
SUPERPRO

Use
●●●
INTENSIVE

EFFICIENCY



- Compact manual vibrator especially designed for vibrating large format tiles.
- Expels the air trapped under the tile and maximises the adhesive coverage.(Do not use for a long period of time on the same tile to prevent the adhesive escaping.)
- Suitable for use on floor and wall tiles.
- Compact and light design weighing just 4.8 kg to facilitate work on walls.
- Floating carbon steel chassis with vibration reduction system for greater user comfort.
- Folded 1.5 mm steel sheet chassis, powder painted in red.
- Vibration plate made of PUR plastic, non-marking and easy to change.
- Easy to change, non-marking contact plate.
- Easy to operate tool with ergonomic double grip.
- Non-adjustable vibration frequency.

	REF.		RPM			
RUBI TRILLER	18948	220-230v 50/60Hz	2940	11 1/2x9 1/2x7 5/16" 29.2x24.2x18.5 cm	10.6 Lb 4.8 kg	1
RUBI TRILLER USA	18978	110-130v 50/60Hz				



RUBI TRILLER ENERGY CAS

COMPACT MANUAL BATTERY-POWERED VIBRATOR.

Especially designed for vibrating large-format ceramic sheets.



NEW!

Category
PREMIUM

Use
INTENSIVE

EFFICIENCY

CAS BATTERY



COMPATIBILITY

• RUBIMIX E-10 ENERGY CAS	18 V 5.2 Ah
• QUAKE ENERGY CAS	18 V 2.0 Ah
• RUBI TRILLER ENERGY CAS	12 V 4.0 Ah
• OCTO-PLUS ENERGY CAS	12 V 2.0 Ah



- Expels the air trapped under the tile and maximises its wetting. (Do not use for a long period of time on the same tile to prevent the adhesive escaping.)
- Suitable for use on floor and wall tiling (suitable for vertical and horizontal application, floors and walls).
- Compact and light design weighing just 5.8 kg to facilitate work on vertical surfaces.
- Floating carbon steel chassis with vibration reduction system for greater user comfort.
- Folded 1.5 mm steel sheet chassis, powder painted in red.
- Vibration plate made of PUR plastic, non-marking and easy to change.
- Easy to operate tool with ergonomic double grip.
- It has a speed regulator to adapt the vibration to the material and substrate being worked on. It includes a circuit breaker safety system.
- Powered by a Li-HD 12V 4Ah battery (compatible with 12 V batteries from the Metabo CAS platform).
- Includes Rubi BMS (Battery Management System), this is a quality electronic controller that protects the battery system from any overloads and overheating. Furthermore, it optimises the performance of the battery by offering a regular energy flow and extends the autonomy of use as well as the battery life.

	REF.		RPM			
RUBI TRILLER ENERGY	10913	12V 4Ah	3000	9 1/2x11 1/2x7 1/16" 24.2x29.2x17.9 cm	12.8 Lb 5.8 kg	1
RUBI TRILLER ENERGY UK	10972					
RUBI TRILLER ENERGY EU	10971					
BATTERY CAS LIHD 12V 4AH	85904					



QUAKE ENERGY CAS

LIGHT AND COMPACT VIBRATOR
For tiles or porcelain sheets.

NEW!



Category
PREMIUM

Use
INTENSIVE

LIGHT

CAS BATTERY



COMPATIBILITY	
• RUBIMIX E-10 ENERGY CAS	18 V 5.2 Ah
• QUAKE ENERGY CAS	18 V 2.0 Ah
• RUBI TRILLER ENERGY CAS	12 V 4.0 Ah
• OCTO-PLUS ENERGY CAS	12 V 2.0 Ah

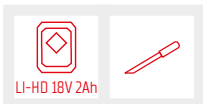

- Designed to prevent the generation of encapsulated air bubbles between the adhesive and the back of the ceramic tile, thus facilitating ideal adhesion between the adhesive and the tile.
- The low weight and wireless system make it easy to use on vertical supports and work at height.
- The double handle with bi-material handle offers greater ergonomics and comfort to the user, and its geometry facilitates better control and stability of the tool during vibrating.
- The contact base with the ceramic tile does not leave marks and is easily replaceable.
- The front handle improves ergonomics and gives the user a better experience.
- Powered by CAS Li-Ion 18V 2Ah battery, compatible with Metabo brand battery tools and with all those that are part of the CAS 18V platform.
- It has a progressive on-off switch (rpm control).
- LED battery-charge indicator.
- New CAS platform LI-POWER 18V-2 Ah battery.

	REF.		RPM				
QUAKE ENERGY CAS	60934	18V 2Ah	10000 Max	5" 127 mm	33 Lb 15 kg	4 Lb 2 kg	1
QUAKE ENERGY CAS UK	60942						
QUAKE ENERGY CAS USA	60938						
QUAKE ENERGY CAS WHITOUT BATTERY	60953						
BATTERY CAS LIPOWER 18V 2AH	85901						



OCTO-PLUS ENERGY CAS

BATTERY-POWERED SUCTION CUP FOR THE HANDLING OF CERAMIC TILES.
Adapts to the surface finish without leaving a mark on the tile.

NEW!



Category
 PREMIUM

Use
●●●
INTENSIVE

150 kg*
 SECURITY

CAS BATTERY



COMPATIBILITY

• RUBIMIX E-10 ENERGY CAS	18 V 5.2 Ah
• QUAKE ENERGY CAS	18 V 2.0 Ah
• RUBI TRILLER ENERGY CAS	12 V 4.0 Ah
• OCTO-PLUS ENERGY CAS	12 V 2.0 Ah

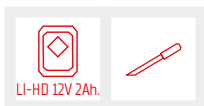

- Bi-material and ergonomic handle.
- Powered by CAS Li-Ion 12V 2Ah battery, compatible with Metabo brand battery tools and with all those that are part of the CAS 12V platform.
- LED battery charge level indicator.
- Maximum load capacity: 150kg.*
- Pressure release mechanism.
- Load loss indicator (LED).
- In the event of a loss of pressure, the vacuum pump is automatically reactivated until the working pressure is reached again.
- *only on smooth surfaces and horizontal loading.

	REF.					
OCTO-PLUS ENERGY CAS EU	66961	12V 2Ah	8" 200 mm	2 Lb 1 kg	33 Lb 15 kg	1
OCTO-PLUS ENERGY CAS UK	66975					
OCTO-PLUS ENERGY CAS USA	66976					
BATTERY CAS LIPOWER 12V 2AH	85903					



INSTALLATION

3
Set



▲ SUPERPRO ***** PROFESSIONAL** **🛡️ SECURITY 140 kg*** **USB BATTERY**

OCTO-USB ENERGY

- Battery suction cup designed for handling ceramic tiles.
- 3.7V battery integrated in the suction cup and charging via USB-C cable.
- In case of loss of pressure, the vacuum pump is automatically reactivated until it reaches working pressure again.
- Maximum load capacity: 140 kg.
- Includes transport case.

	REF.	📏	🏋️	🏋️*	📦
OCTO-USB ENERGY	66967	8" 200 mm	2 Lb 1 kg	3.3 Lb 15 kg	2



◇ PREMIUM **VACUUM** **🛡️ SECURITY 110 kg** **NO MARKS**

GSC-200 VACUUM SUCTION CUP

- Suction cup for the manipulation of large ceramic tiles and heavy porcelain slabs.
- Adapts to the surface without leaving any marks.
- Fixing by vacuum manual pump.
- Load loss indicator (red mark).
- Pressure release mechanism.
- Maximum load capacity: 110 kg.
- High resistance plastic body.
- Transport suitcase.

	REF.	🏋️*	📦
GSC-200 VACUUM SUCTION CUP	21951	3.3 Lb 15 kg	1



◇ PREMIUM **VACUUM** **🛡️ SECURITY 110 kg**

SUCTION CUP WITH VACUUM PUMP SC-200

- Suction cup for handling large and heavy tiles.
- Adapts to surface finish.
- Suction applied by manual vacuum pump.
- Load loss indicator (red mark).
- Pressure-release mechanism.
- Maximum load capacity: 110kg.
- Transport carry case.

	REF.	🏋️*	📦	📦
SC-200 VACUUM PUMP CUP	18919	3.3 Lb 15 kg	1	90

PRO



TILE GAP CLOSER

- For a precise and easy adjustment of the gap between tiles during floor or wall tiling.
- Large diameter suction cups (150 mm) for any kind of tile surface (flat, rough, structured, etc.)
- For lateral displacement of tiles and gap reduction between 0 - 40 mm.
- Enables to equal the level of the tiles between 0 - 20 mm.
- Maximum lifting capacity up to 100 Kg (220 lbs).

	REF.				
TILE GAP CLOSER	60926	18 7/8" 48X15X12 cm	796 Lb 361 kg	8,47 Lb 3,84 kg	1

SUPERPRO



TILE BEATING BLOCK

- For a good settlement of tiles.
- Waterproof and high wear resistance wood.
- Perfect flatness.
- Dimensions: 15 3/4" x 5 3/4" (40x14,5 cm).
- With white natural rubber sheet to prevent damage to the tile.

	REF.	
TILE BEATING BLOCK 40 X 14,5 CM. WITH RUBBER	72980	1

PREMIUM

ERGONOMIC



ERGO TILE BEATER

- For a good settlement of tiles.
- It facilitates the extraction of the air that remains between the tile and the adhesive.
- With a bi-material handle for maximum comfort and ergonomics.
- Metal plate for complete rigidity and long durability, reinforced with rubber to avoid damaging the ceramic tiles.
- Exact, balanced weight.

	REF.	
ERGO TILE BEATER	28900	1





ELECTRIC

TILE CUTTING

Electric cutters and mitre saws
Circular saw and vacuum cleaner



SELECTION TABLE

						 with plunge effect
		cm	inch	mm	inch	
●●● Intensive	DX-N	148	58 7/16"	300-350	12-14"	⊙
	DR	84	33"			
	DS-N	152	59 13/16"	250	10"	-
	DCX-XPERT	155	61"			
●●● Professional	DT	90	35 1/2"	125	5"	⊙
	DC-PHYTON	121	48"			
	DL	120	47"	200	8"	
	DV	106	41 3/4"			
●●● Occasional	DU-EVO	85	33"	∞		-
	ND					



				W										
PREMIUM	Intensive	DX-350 N 1000	3 CV/HP	2,2 KW	(*4) 118,5 cm 46 5/8"	(*4) 83,5 X 83,5 cm 32 7/8 X 32 7/8"	∞	(*5) 65 mm 2 9/16"	105 / 220 mm 4 1/8" / 8 11/16"	300 - 350 mm 12 - 14"	92 Kg. 203 Lb.			
		DX-350 N 1300	3 CV/HP	2,2 KW	(*4) 148,5 cm 58 7/16"	(*4) 105 X 105 cm 41 5/16 X 41 5/16"	∞	(*5) 65 mm 2 9/16"	105 / 220 mm 4 1/8" / 8 11/16"	300 - 350 mm 12 - 14"	100 Kg. 220 Lb.			
		DS-250 N 1000	3 CV/HP	2,2 KW	102 cm 40 3/16"	72 X 72 cm 28 3/8 X 28 3/8"	∞	(*3) 25 mm 1"	51 mm 2 1/16"	250 mm 10"	91,5 Kg. 201.7 Lb.			
		DS-250 N 1300	3 CV/HP	2,2 KW	132 cm 51 15/16"	93,5 X 93,5 cm 36 13/16 X 36 13/16"	∞	(*3) 25 mm 1"	51 mm 2 1/16"	250 mm 10"	96,5 Kg. 212.7 Lb.			
		DS-250 N 1500	3 CV/HP	2,2 KW	152 cm 59 13/16"	107,5 X 107,5 cm 42 5/16 X 42 5/16"	∞	(*3) 25 mm 1"	51 mm 2 1/16"	250 mm 10"	100 Kg. 220 Lb.			
		DCX-250 XPERT 1250	2 CV/HP	1,5 KW	125 cm 49 3/16"	90 X 90 cm 35 7/16 X 35 7/16"	∞	50 mm 1 15/16"	61 / 90 mm 2 3/8" / 3 9/16"	250 mm 10"	83 Kg. 183 Lb.			
		DCX-250 XPERT 1550	2 CV/HP	1,5 KW	155 cm 61"	110 X 110 cm 43 5/16 X 43 5/16"	∞	50 mm 1 15/16"	61 / 90 mm 2 3/8" / 3 9/16"	250 mm 10"	-			
SUPERPRO	Professional	DR-350	3 CV/HP	2,2 KW	(*4) 84 cm 33"	(*4) 43,5X43,5 cm 17 X 17"	∞	(*5) 71 mm 2 13/16"	95 / 150 mm 3 3/4" / 5 7/8"	300 - 350 mm 12 - 14"	63 Kg. 139 Lb.			
		DT-250 MAX	2,4 CV/HP	1,8 KW	90 cm 36"	60 X 60 cm 24 X 24"		25 mm 1"	90 mm 3 9/16"	250 mm 10"	45 kg. 99 Lb.			
		DC-250 PYTHON 850	1,5 CV/HP	1,1 KW	(*2) 98 cm 38 9/16"	(*2) 69,5 X 69,5 cm 27 3/8 X 27 3/8"	∞	50 mm 1 15/16"	61 / 90 mm 2 3/8" / 3 9/16"	250 mm 10"	54,5 Kg. 120 Lb.			
		DC-250 PYTHON 1200	1,5 CV/HP	1,1 KW	(*2) 120,5 cm 48"	(*2) 85 X 85 cm 33 7/16 X 33 7/16"	∞	50 mm 1 15/16"	61 / 90 mm 2 3/8" / 3 9/16"	250 mm 10"	59,5 Kg. 131 Lb.			
		DL-125 1200	2,3 CV/HP	1,8 KW	120 cm 47 1/4"	90x90 cm 35 7/16" X 35 7/16"	∞	20 mm 13/16"	20 mm 13/16"	125 mm 4 1/8"	50 Kg. 110.23 Lb.			
PRO	Occasional	DV-200 1000	1,5 CV/HP	1,1 KW	106 cm 41 3/4"	76,5 X 76,5 cm 30 1/8 X 30 1/8"	∞	(*3) 15 mm 9/16"	35 mm 1 3/8"	200 mm 8"	57,5 Kg. 126.8 Lb.			
		DU-200 EVO 650	1,1 CV/HP	0,8 KW	65 cm 26"	45 X 45 cm 18 X 18"	∞	20 mm 13/16"	35 mm 1 3/8"	200 mm 8"	22,5 Kg. 49.6 Lb.			
		DU-200 EVO 850	1,1 CV/HP	0,8 KW	85 cm 33"	60 X 60 cm 24 X 24"	∞	20 mm 13/16"	35 mm 1 3/8"	200 mm 8"	27,2 Kg. 60 Lb.			
		ND-200	1,1 CV/HP	0,8 KW	∞	∞	(*1) 23 cm 9"	24 mm 15/16"	40 mm 1 9/16"	200 mm 8"	17,2 Kg. 37.9 Lb.			
ND-180	0,7 CV/HP	0,55 KW	∞	∞	20 cm 8"	22 mm 7/8"	35 mm 1 3/8"	180 mm 7"	13,6 Kg. 29 Lb.					

(*1) With lateral stop.
 (*2) 13/32" (10mm) thick material and plunge effect.
 (*3) With special decks for mitering.
 (*4) With Ø12" (300mm) blade, 13/32" (10mm) thick material and plunge effect.
 (*5) With Ø14" (350mm) blade.
 (*6) Saw head in the lowest position.



DX-350 N

MOBILE HEAD MACHINE WITH PLUNGE EFFECT FOR TOTAL VERSATILITY.

For all types of ceramic and porcelain tiles, building materials such as marble, granite, facade and fireproof bricks.



Category



PREMIUM

Use



INTENSIVE



POWER

VERSATILITY



3 cv/hp

8 11/16"
220 mm

- **Motor assembly mounted on sliding bearings for maximum precision and reliability. Perfect finishes.**
- **Folding legs with integrated castors: Pyramidal orientation to improve the stability and safety of the machine.**
- **Aluminium structure. Lighter cutter with maximum resistance to working conditions.**
- **High performance plunge effect. Maximum cutting height.**
- Equipped with protective safety system for segmented blades.
- With thermal security switch.
- Water pump cooling of blade with flow control valve.
- Diamond blade Ø 14" (350 mm) not included.
- Allows the use of a Ø 12" (300 mm) blade.
- Adjustable mobile head with plunge effect capability.
- Motor on top and belt transmission.
- With lateral stop for repetitive cuts.
- Aluminium working surface removable for easy cleaning.
- Removable water tank system.
- 2mW line laser.
- Circular level for easy field installation.
- Machine supplied without cable.
- Supplied with ZERO DUST system already assembled. Also provided with a second anti-splash standard protector



	REF.	⚡	RPM	📏	📐	🔪	🔪	⊕	⊖	📏	📏	📦	🚚	
DX-350 N 1000	52905	230V-50 Hz.	2800	40 3/8" 102.5 cm	46 5/8" 118.5 cm	32 7/8x32 7/8" 83.5x83.5 cm					66 15/16x33 7/8x56 5/16" 170x86x143 cm	203 Lb 92 kg		
	52906	220V-60 Hz.	3400											
DX-350 N 1300	52915	230V-50 Hz.	2800	52 3/16" 132.5 cm	58 7/16" 148.5 cm	41 5/16x41 5/16" 105x105 cm	2 9/16" 65 mm	4 1/8 / 8 11/16" 105 / 220 mm	1" 25.4 mm	12-14" 300-350 mm	78x33 7/8x56 5/16" 200x86x143 cm	220 Lb 100 kg	1	**1
	52916	230V-60 Hz.	3400											
	52918	120V-60 Hz.Inch.												
	52927	230V-50 Hz. 2.4HP	2830											
	52928	110V-50 Hz.	2700											

Cutting capabilities may vary depending on the head position, special plates and disc diameter.
Ref. 52927 and 52928: 2.4 CV/HP.

ACCESSORIES	REF. 51916	REF. 51915	
	Tile Fixer DV/DC/DCX/DS/DX		Set of flanges Ø184mm DX-350
			Cables with plug

DS-250 N

MOBILE HEAD MACHINE FOR HIGH ACCURACY.

For wall tiles, floor tiles, porcelain tiles, marble, granite and other materials.



Category



PREMIUM

Use



INTENSIVE



POWER



MITRE CUT



3 cv/hp

2 1/16"
51 mmmm
inch

- **Motor assembly mounted on sliding bearings for maximum precision and reliability. Perfect finishes.**
- **Folding legs with integrated castors: Pyramidal orientation to improve the stability and safety of the machine.**
- **Wheels and handle included. Easy transport.**
- **Aluminium structure. Lighter cutter with maximum resistance to working conditions.**
- Removable aluminium tables for easy cleaning of the machine.
- With thermic security switch.
- Water pump cooling of blade with flow control valve.
- Diamond blade Ø10" (250mm) not included.
- With a double set of flanges, one especially designed for mitre cuts.
- Motor assembly mounted on sliding bearings for mitre cuts.
- Safety protector for segmented blades.
- With lateral stop for repetitive cuts.
- Removable water tank system.
- 2mW line laser.
- Spirit level for easy field installation.
- Machine supplied without cable.
- Supplied with ZERO DUST system already assembled. Also provided with a second anti-splash standard protector



REF.		RPM												
DS-250 N 1000	52920	230V-50 Hz.	2800	40 3/16" 102 cm	28 3/8x28 3/8" 72x72 cm	2 1/16" 51 mm	1" 25 mm	1" 25.4 mm	10" 250 mm	66 15/16x33 7/8x50" 170x86x127 cm	2017 Lb 915 kg	243 Lb 110 kg	1	**1
DS-250 N 1300	52930			51 15/16" 132 cm	36 13/16x36 13/16" 93.5x93.5 cm					78x33 7/8x50" 200x86x127 cm	2127 Lb 96.5 kg	265 Lb 120 kg		
DS-250 N 1500	52940	220V-60 Hz.	3400	59 13/16" 152 cm	42 5/16x42 5/16" 107.5x107.5 cm	86 5/8x33 7/8x50" 220x86x127 cm	220 Lb 100 kg	276 Lb 125 kg						
	52942													

Cutting capabilities may vary depending on the head position, special plates and disc diameter. Ref. 52945 (3F): 4 CV/HP.

ACCESSORIES		REF. 51916 Tile Fixer DV/DC/DCX/ DS/DX		REF. 51914 Roller Table Extension DU/ DC/DCX/DS/DX (from 2013)		Cables with plug

DCX-250 XPERT

PROFESSIONAL MOVING HEAD MACHINE FOR WET CUTTING WITH PLUNGE EFFECT.
For occasional cutting of natural stone such as marble or granite.



Category



PREMIUM

Use



INTENSIVE



RELIABILITY



PRECISION



2 cv/hp

3 9/16"
90 mmmm
inch

PATENTED



- Reinforced aluminium chassis with innovative triple beam system and steel sides. Improves the stability and rigidity of the chassis.
- Reinforced cutting guide for a better cut finish.
- C3-PYTHON System increases cooling efficiency and reduces water dispersion.
- High performance plunge effect. Cutting height adjustment.
- Includes transport handle and off-road type reinforced wheels, which provide better transportability and handling of the machine.
- Steel double settling system for improved efficiency and water recovery.
- Angular measurement with aluminium square adjustable from 0° to 60° for repetitive cuts.
- Includes reinforced folding legs with folding-prevention system and quick lock.
- External and easy to remove water tank with 30 L capacity.
- Includes improved splash guard system with auto-sliding protective cover.
- Patented ZERO DUST system exclusive to RUBI certified by the TNO, for safe exposure thanks to the reduction of the breathable dust particles generated during the cut.
- Ergonomic bi-material handle for comfortable operation of the cutting head.
- Earth integrated into the chassis.
- Does not include power cable.
- Not Supplied with a blade.



REF.		RPM												
DCX-250 XPERT 1250	52960	230V-50Hz/230V-50Hz.	2750	49 3/16" 125 cm	52 3/8" 133 cm	35 7/16x35 7/16" 90x90 cm	2 3/8 / 3 9/16" 60 / 90 mm	115/16" 50 mm	1" 25.4 mm	10" 250 mm	172 Lb 78 kg	75 9/16x29 1/8x51 3/16" 192x74x130 cm	1	**1
	52961	110V-50Hz.												
	52929	220V-60Hz.	3350											
	52962	120V-60Hz.												
DCX-250 XPERT 1550	52970	230V-50Hz.	2750	61 1/16" 155 cm	64 3/16" 163 cm	43 5/16x43 5/16" 110x110 cm	2 3/8 / 3 9/16" 60 / 90 mm	115/16" 50 mm	1" 25.4 mm	10" 250 mm	190 Lb 86 kg	87 3/8x29 1/8x51 3/16" 222x74x130 cm	1	**1
	52971	110V-50Hz.												
	52937	220V-60Hz.	3350											
	52972	120V-60Hz.												

The cutting capacities can vary depending on the head position, special flanges and disc diameter.

ACCESSORIES		REF. 51927 Set of flanges Ø170mm DC PYTHON/DCX		REF. 57941 Table Extension DV/DC/ DCX/DS/OX		Cables with plug

DC-250 PYTHON

MOVING HEAD MACHINE, VERSATILITY AND PRECISION

For cutting porcelain stoneware.



Category



SUPERPRO

Use



PROFESSIONAL

VERSATILITY



1.5 cv/hp



3 9/16"
90 mm



mm
inch



- **Motor assembly mounted on sliding bearings for maximum precision and reliability. Foldable at 45° for mitre. Direct drive motor.**
- **Steel plate structure. Sturdy and maximum resistance to working conditions.**
- **Patented ZERO DUST system exclusive to RUBI and certified by TNO, for safe exposure because of reduction of respirable dust particles generated during cutting.**
- **C3 Python cooling system. New adjustable refrigeration system. Allows to adjust the point of water's fall depending on the material's thickness, getting a direct impact of the water in the cutting point. This allows to increase the refrigeration's efficiency and to reduce water dispersion.**
- Foldable legs with wheels for an easier transportation and removable tables for easy cleaning of the machine.
- Adjustable aluminium square (0° – 60°) with lateral stop for repetitive cuts at 0° and 45°.
- Safety protector for turbo and segmented blades.
- Blade cooling by water (50W water pump) with flow control.
- Includes diamond blade CEV-SUPERPRO Ø250 (*Ref. 56949 includes CPA- SUPERPRO Ø250 blade).
- Supplied without cable.



REF.	⚡	RPM	📏	🔪	📐	🔧	🔩	🔩	🔩	🔩	🔩	🔩	🔩	🔩
DC-250 PYTHON 850	56941	230V-50Hz	2790											
	56937	220V-60Hz	3436	33 11/16"	38 9/16"	27 3/8x27 3/8"					53 15/16x23 1/4x51 9/16"	120.2 Lb	153.2 Lb	
	56938	110V-50Hz		85.5 cm	98 cm	69.5x69.5 cm					137x59x131 cm	54.5 kg	69.5 kg	
DC-250 PYTHON 1200	56939	230V-50Hz.	2790											
	56943	220V-60Hz.	3436				2 3/8 / 3 9/16"	2 3/16"		10"				
	56947	110V-50Hz.		42 1/2"	47 5/8"	33 7/16"	61 / 90 mm	55 mm		250 mm	63 3/4x32 5/16x51 9/16"	131.28 Lb	165 Lb	1
	56949	230V-50Hz.	2790	108 cm	121 cm	85X85 cm					162x82x131 cm	59.55 kg	75 kg	**1

The cutting capacities can vary depending on the head position, special flanges and disc diameter.

ACCESSORIES		REF. 57941 Table Extension DW/DC/DCX/DS/DX		REF. 51914 Roller Table Extension DU/DC/DCX/DS/DX [from 2013]		Cables with plug
--------------------	--	--	--	---	--	------------------

DL-125

MOBILE HEAD CUTTER, POWERFUL, LIGHT AND TRANSPORTABLE.

Suitable for intensive cutting of porcelain and all kinds of ceramic tiles. Occasional cut of natural stone.



Category



SUPERPRO

Use



PROFESSIONAL



LIGHT



TRANSPORTABLE



2.3 cv/hp



13/16"

20 mm



47"

120 cm



mm

inch



- **35 cm wide extruded aluminum chassis, ideal for small workplaces.**
- **Wheels and handle for easy transport, as well as height-adjustable legs for stability.**
- **Equipped with blade adjustment system.**
- **Multiple accessories included with the machine.**
 - Electric machine with cutting effect.
 - Motor set mounted on bearings for maximum precision and reliability.
 - 1800W (2.4CV) universal motor.
 - 125mm diamond blade included (cutter compatible with 115–130mm blades).
 - Reinforced aluminum chassis (double beam system). Improves the stability and rigidity of the chassis.
 - Safety protection system for Blades.
 - Equipped with ZERO DUST system.
 - Removable water tank for easy cleaning (8L).
 - Ergonomic transport and adjustment improvements (motor adjustment, support adjustment, carriage wheel adjustment).
 - Accessories included: Double lateral extension, repetitive cuts, laser and lateral stop for repetitive cuts included (adjustable from 8mm to 20mm tiles).
- The machine is supplied without cable.



NEW!



3
YEARS
WARRANTY

1 2 3 4 5
Cut & Drill

REF.										
DL-125 1200	56924	220-240V 50/60Hz.	47" 120 cm	35 7/16x35 7/16" 90x90 cm	13/16" 20 mm	13/16" 20 mm	√	5" 125 mm	1	**1

The cutting capacities can vary depending on the head position, special flanges and disc diameter.





DV-200

MOBILE HEAD ELECTRIC CUTTER OF MAXIMUM FUNCTIONALITY AND RELIABILITY.
For all types of ceramic and porcelain tiles and other materials.



Category
SUPERPRO

Use
●●●
PROFESSIONAL

MITRE CUT



- **Set motor on sliding bearings for maximum accuracy and cut quality.**
- **C³ System, improves blade's cleaning and cooling for a higher performance.**
- **Removable aluminum tables for easy cleaning of the machine.**
- **Folding legs with built-in wheels for a more comfortable transport.**
- Includes diamond disc CEV PRO Ø 200 mm.
- Direct motor, single phase 1.1 kW (1.5 HP) with thermal protector.
- Water pump cooling of blade with flow control.
- Reinforced chassis, greater structural rigidity.
- Adjustable lateral stop (0 ° to 60 °) for repetitive cuts.
- Large work area (100x48.5cm) suitable for large formats.
- Working height of 84.5 cm. For improved user ergonomics.
- Double Switch (ON/OFF) quick and easy access.
- Foldable head at 45° for miter cuts that can cut up to 106 cm length.
- Machine supplied without cable.



	REF.	⚡	RPM	↔	⬠	⬢	⬡	⬤	⊙	⊘	🛠️	📦	🚚
DV-200 1000	54911	230V-50 Hz.	2790	41 3/4" 106 cm	30 1/8x30 1/8" 76.5x76.5 cm	1 3/8" 35 mm	9/16" 15 mm	√	8" 200 mm	63x23 1/4x46 1/16" 160x59x117 cm	133.4 Lb 60.5 kg	1	**1
	54913	110V-50Hz.											
	54914	120V-60Hz.											

The cutting capacities may vary depending on the position of the head, special flanges and disc diameter.

ACCESSORIES		REF. 54999 Laser & Level Kit DV/DC/ DCX/DS/DX		REF. 51916 Tile Fixer DV/DC/DCX/ DS/DX		REF. 57941 Table Extension DV/DC/ DCX/DS/DX



DU-200 EVO

MOBILE HEAD CUTTER FOR RENOVATIONS AND LIGHT WORKS.
To cut ceramic and porcelain wall and floor tiles.



Category



Use



OCCASIONAL



LIGHT



TRANSPORTABLE



11 cv/hp

1 3/8"
35 mm33 7/16"
85 cmmm
inch

PATENTED



- **Built-in foldable legs. Very easy to fix.**
- **With wheels and handle for a more comfortable transport and handling.**
- **External water tank, easy to handle and clean.**
- **C³ System, improves blade's cleaning and cooling for a higher performance.**
- Motor assembly mounted on sliding bearings and foldable for mitre cuts.
- With lateral stop for repetitive cuts and adjustable square from 0 to 45°.
- Direct drive motor with thermal protector and reinforced chassis.
- Corrugated tube to protect power cable and water pipe.
- Front blade cooling diffuser with 5 positions depending on the hardness or the abrasion of the material.
- Bi-material handle, better ergonomics.
- With CEV-SUPERPRO diamond disc Ø 200 mm.



	REF.	⚡	RPM											
DU-200 EVO 650	55903	230V-50Hz.	2915	25 9/16" 65 cm	17 11/16x17 11/16" 45x45 cm				√	8" 200 mm	46 1/16x15 3/8x40 3/16" 117x39x102 cm	49.6 Lb 22.5 kg	1	9
	55905	230V-50Hz. UK												
	55906	110V-50Hz. UK	2670											
	55907	120V-60Hz. USA	3200											
	55938	220V-60Hz.	3490											
DU-200 EVO 850	54975	230V-50Hz.	2915	33 7/16" 85 cm	24x24" 60x60 cm					8" 200 mm	53 9/16x15 3/8x40 3/16" 136x39x102 cm	60 Lb 27.2 kg	1	6
	54976	120V-60Hz. USA	3490											
	54977	230V-50Hz. UK	2915											

The displayed product may not correspond exactly with the actual model.

ACCESSORIES		REF. 5973 Cleaning Block		REF. 5974 N-Cleaning Block
--------------------	--	------------------------------------	--	--------------------------------------

DT-250 MAX

TRANSPORTABLE ELECTRIC CUTTER WITH MITRE EFFECT. GOOD FINISH.
For cutting stoneware, tiles, ceramics, refractories and other materials.



Category



SUPERPRO

Use



PROFESSIONAL



TRANSPORTABLE

FAST



2.4 cv/hp

3 9/16"
90 mmmm
inch

- Python cooling system combined with the Zero Dust system, keeps your work area clean by reducing the production of splashes.
- It incorporates a tubular steel support with wheels and foldable, to transport the machine easily.
- With lateral stop for repetitive cuts with adjustment from 0° to 45° and magnetic support for the blade key.
- Diamond blade for fast, smooth cuts with a long service life.
- Laser indicator to facilitate ceramic placement and obtain more precise cuts.
- Tilting cutting head adjusts for precise 22.5° and 45° bevel cuts.
- Tank with level indication min. and max. Maximum capacity: 19 l.
- It incorporates an aluminum table with a rubber surface with a cutting capacity of 90 cm.
- Available accessory Ref. 58916 that extends the table up to 120 cm.



NEW!



3
YEARS
WARRANTY

1 2 3 4 5
Cut & Drill

REF.	⚡	RPM	📏	📏	📏	📏	📏	📏	📏	📏	📏	📏	📏
DT-250 MAX	58909	220/240 V - 50/60 Hz	4000	35 7/16" 90 cm	24" 60 cm	3 9/16" 90 mm	1" 25 mm	1" 25.4 mm	10" 250 mm	63x368 1/8x48 7/16" 160x935x123 cm	99 Lb 45 kg	1	-
DT-250 MAX UK	58915												
	58913	110/130 V - 50/60 Hz											

The cutting capacities can vary depending on the head position, special flanges and disc diameter.

ACCESSORIES



REF. 58916
EXTENDABLE TABLE DT - 250 MAX



REF. 58917
Set of flanges for DT-250 MAX



DR-350

ELECTRIC SAW WITH PLUNGE EFFECT.

For all types of building materials like: masonry bricks, facade bricks, fireproof bricks, marble, granite and ceramic tiles.



Category



SUPERPRO

Use



INTENSIVE



POWER



IDEAL CUTTING WORK MATERIAL

3 cv/hp

5 7/8"
150 mm33 1/16"
84 cmmm
inch

- **Head with high performance plunge effect. Large cutting capacity.**
- **Equipped with ZERO DUST system. Tested and certified by TNO.**
- **Large table for a larger work surface and comfort.**
- **Steel structure robustness. Increased resistance to the demands of intensive work.**
- Equipped with protective safety system for segmented blades.
- With thermal protector.
- Adjustable head to 45°.
- Large table 23 1/16"x19 1/2" (58.5x49.5cm).
- Blade cooling by water pump with integrated regulation valve.
- Diamond blade Ø12-14" (300-350mm) not included.
- Machine supplied without cable.
- Direct drive motor.
- Supplied with new ZERO DUST system already assembled. Also provided with a second anti-splash standard protector.



	REF.	⚡	RPM	☰	📐	📐	🔪	📏	📏	📏	📏	📏	📏	📏
DR-350	56940	230V-50 Hz.	2800	28 1/8"	33 1/16"	17 1/8x17 1/8"	3 3/4 / 5 7/8"	12-14"	45 1/4x27 3/16x52	139 Lb	√	1	**1	
	56942	220V-60 Hz.		71.5 cm	84 cm	43.5x43.5 cm	95 / 150 mm	300-350 mm	3/16"	115x69x132.5 cm				

The cutting capacities may vary depending on the position of the head, special flanges and disc diameter.

ACCESSORIES			
	Cables with plug		REF. 5973 Cleaning Block
			REF. 5974 N-Cleaning Block





ND-200

PORTABLE CUTTER, IDEAL FOR FINISHINGS AND RENOVATIONS.
For cutting ceramic tiles and other materials.



Category
PRO

Use
●○○
OCCASIONAL

LIGHT

DURABILITY



- **Lightweight and compact, ideal for working in small spaces.**
- **Stainless steel folding table. More durability.**
- **Fast positioning system at 45°. Easy to use.**
- **Removable disk protector for vertical cuts. Simplifies creation of light boxes, frames, etc...**
- CEV-PRO Ø8" (200mm) diamond blade included.
- Water cooling of the blade.
- Lateral stop to allow repetitive cuts.
- Electric cable: 4.9ft (1,5m).
- Direct drive with thermal protector.

	REF.	⚡	RPM	∞	∞	9"	1 9/16"	√	8"	20 1/16x20 11/16x9 7/16"	379 Lb	1	8
ND-200	45910	230V-50 Hz.	2790	∞	∞	9"	1 9/16"	√	8"	20 1/16x20 11/16x9 7/16"	379 Lb	1	8
	45915	230V-50 Hz.UK											
	45911	220V-60 Hz.	3240										
	45916	110V-50 Hz.UK	2750										

The cutting capacities may vary depending on the position of the head, special flanges and disc diameter.

ACCESSORIES

REF. 5973
Cleaning Block

REF. 5974
N-Cleaning Block



ND-180

PORTABLE CUTTER, IDEAL FOR FINISHINGS AND RENOVATIONS.
For cutting ceramic tiles, ideal for floor and wall tiles.



Category
PRO

Use
OCCASIONAL

LIGHT



- **Water cooling of the blade.**
- **With foldable table for mitre cutting up to 7 7/8" (20cm).**
- **With lateral stop for repetitive cuts.**
- **Guide for 45° cuts.**
- Single-phase motor.
- For wall tiles, floor tiles and other materials.
- Diamond blade Ø7" (180mm) included.
- With thermic security switch.
- Electric cable: 4.9ft (1,5m).
- Model with carry case, supplied with 2 blades. (Ref. 25945, 25964, 24956)

	REF.			RPM									
ND-180	25925			230V-50 Hz.							26 Lb 11.8 kg	1	24
	25927			220V-60 Hz.									
ND-180 USA	25963			120V-60 Hz.	2800	∞	∞	8" 20 cm	1 3/8" 35 mm	7" 180 mm	15 9/16x15 3/16x9 5/8" 39.5x38.5x24.5 cm	1	
ND-180	25945	√		230V-50 Hz.							29.01 Lb 13.16 kg	1	12
ND-180 UK.	24956												

The breaking capacities may vary depending on the position of the head, special flanges and disc diameter.

ACCESSORIES

REF. 5973
Cleaning Block

REF. 5974
N-Cleaning Block

ACCESSORIES FOR ELECTRIC CUTTERS

◆ SUPERPRO



CLEANING BLOCK

- For cleaning of diamond blades.

REF.



CLEANING BLOCK	05973	5
----------------	-------	---

◆ SUPERPRO



N-CLEANING BLOCK

- Specifically designed to bring back the diamonds on the rim of diamond blades when cutting porcelain.

REF.



N-CLEANING BLOCK	05974	5
------------------	-------	---

◆ SUPERPRO



SET OF FLANGES FOR MITRING CUTS.

- To reduce saw flex in miter cuts.
- Available in several models.
- Flange for reinforced saws.

REF.



SET OF FLANGES Ø184MM DX-350	51915	1
SET OF FLANGES Ø170MM DC PYTHON/DCX	51927	
SET OF FLANGES Ø130MM DV/DC/DCX/DX-250	57991	
SET OF FLANGES FOR DT-250 MAX	58917	

◆ SUPERPRO



TABLE EXTENSION

- Increases work surface for large format tiles. 23 5/8"(600x280mm).
- Maximum weight: 33Lb. (15kg).
- Compatible with various models of cutting machines.

REF.



TABLE EXTENSION DV/DC/DCX/DS/DX	57941	1
---------------------------------	-------	---

◆ SUPERPRO

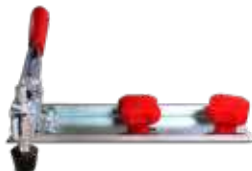

TILE FIXER DV/DC/DCX/DS/DX

- Allows the fixing of the tile during cutting, thus avoiding sudden movements.
- Accessory adaptable to DV,DC,DS and DX series (up to 2009).

REF.



TILE FIXER DV/DC/DCX/DS/DX	51916	1
----------------------------	-------	---

◆ SUPERPRO



ROLLER TABLE EXTENSION

- With rollers to simplify movement of the tiles.
- With adjustable foldable legs.
- Work surface 26 9/16"x22 5/8" (675x575mm) and maximum weight 154lb (70kg).
- Installation on both sides of the machine.

REF.



ROLLER TABLE EXTENSION DU/DC/DCX/DS/DX (FROM 2013)	51914	1
--	-------	---



SUPERPRO

NEW!



EXTENDABLE TABLE DT – 250 MAX

- For better grip of large tiles with a cutting capacity of up to 120 cm.
- Exclusive for DT –250 MAX.
- Extendable legs included to prevent tipping of the support.
- Main table manufactured in aluminium with a rubber layer.
- Guides manufactured in extruded aluminium with reinforcing cross-bars.

	REF.	
DT-250 MAX UK	58916	1

SUPERPRO



ADJUSTABLE LENGTH LATERAL STOP DC/DCX/DS/DX

- For fixing large format tiles.
- Adjustable to the maximum length of electric cutter.
- Tile is held laterally thus avoiding any movement.
- Especially suitable for blocking and execution of repetitive miter.

	REF.	
ADJUSTABLE LENGTH LATERAL STOP DC/DCX/DS/DX	54844	1

SUPERPRO



LATERAL STOP FOR DC/DCX/DS/DX

- Facilitates positioning of the tile, while reducing the percentage of errors.

	REF.	
LATERAL STOP FOR DC/DCX/DS/DX	54822	1

SUPERPRO



LASER & LEVEL KIT DV/DC/DCX/DS/DX

- Kit includes:
- Circular bubble level to facilitate proper positioning of the electric cutter.
- Laser Tracer indicating the passage of the disc and facilitates placement of material.
- Laser power: 2 mW
- Laser Class: 2
- Not compatible with DC–250 PYTHON models.

	REF.	
LASER & LEVEL KIT DV/DC/DCX/DS/DX	54999	1

SUPERPRO



CABLES WITH PLUG

- For machines supplied without cable, please include both the reference of the machine and the reference of the correct voltage cable with plug which is suitable for the Country of destination.
- Approximate length 3.5m.

	REF.		
CABLE WITH PLUG 230/50 EUR	58850	230V - 50 Hz EUR	1
CABLE WITH PLUG 380/50 EUR	58851	380v-50 Hz EUR	
CABLE WITH PLUG 110/50 UK	58852	110v-50 Hz UK	
CABLE WITH PLUG 230/50 UK	58853	230V-50 Hz UK	
CABLE WITH PLUG 120/60 15A 12AWG USA	58854	120V-60 Hz 15 A 12AWG USA	
CABLE WITH PLUG 220/60 15A 12AWG USA	58856	220V-60 Hz 15 A 12AWG USA	
CABLE WITH PLUG 230/50 10A AUS	58863	230v - 50 Hz. 10A AUSTR.	
CABLE WITH PLUG 120/60 30A 10AWG USA	58869	120V-60 Hz. 30A 10AWG	



CIRCULAR SAW TC-180

PRECISE CUTTING ON LARGE FORMAT MATERIALS.

For dry and wet cutting of ceramic, porcelain and other materials.



Category
SUPERPRO

VERSATILITY

LIGHT

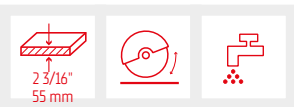

- **Practical cutter and easy to use for large pieces.**
- **Double cooling system, wet and dry. Greater adaptability to environment.**
- **Guiding mark for better visibility of the line of cut.**
- **Easy adjustment of cutting thickness. Greater versatility and adaptability to the different materials.**
- Especially suitable for large pieces.
- Allows the user to reduce manipulation, handling heavy or awkward use.
- Content:
 - Blade Ø180mm TCR-180 SUPERPRO.
 - Parallel guide.
 - Cable with PRCD switch (differential).
 - Cone reducer for vacuum cleaner.
 - Transport case.

	REF.		RPM	W										
TC-180	50939	√	5800	1800 W	230V / 50-60Hz	2 3/16" 55 mm	7" 180 mm	7/8" 22.2 mm	13x17 11/16x14 15/16" 33x45x38 cm	√	14.8 Lb 6.7 kg	24 Lb 11 kg	1	10

ACCESSORIES

	REF. 50957 Guide connector		REF. 50958 Fixing C-clamp		TC-180 Guides
--	--------------------------------------	--	-------------------------------------	--	---------------



CIRCULAR SAW TC-180 KIT

• Kit includes:

• 1 x Circular Cutter TC-180 230V 50/60Hz (Ref. 50939), 1 x Blade TCR-180 (Ref. 31975), 2 x Guide 80 cm. for TC-180 (Ref. 50956), 1 x Connector guides (Ref. 50957), 2 x Fixing Clamps (Ref. 50958).



	REF.		
TC-180 230V/50-60HZ KIT	50994	1	8



TC-180 GUIDES

- Aluminium Guide for straight cuts.
- Ability to connect multiple guides through the connector (Ref. 50957).



	REF.			
80CM GUIDE FOR TC-180 (31 1/2")	50956	32 5/16x7 5/16x13/16" 82x18.5x2 cm	2.78 Lb 1.26 kg	1
120CM GUIDE FOR TC-180 (47 1/4")	50959	47 5/8x7x13/16" 121x18x2 cm	4 Lb 1.8 kg	



GUIDE CONNECTOR

- Allows the connection of multiple guides to increase cutting length.



	REF.	
GUIDE CONNECTOR	50957	1



FIXING C-CLAMP

- Highly recommended for fixing the guide on the tile and preventing movement through out the cut, thus achieving a cleaner cut.



	REF.	
FIXING C-CLAMP	50958	1

PRO-EDGER BEVELLING AND MITRING ACCESSORY

PROFESSIONAL PORTABLE SYSTEM FOR INTENSIVE USE, ESPECIALLY DESIGNED FOR DRY BEVELLING AND MITRING PRINCIPALLY OF LARGE FORMAT TILES.

It can bevel and mitre porcelain, ceramic and any natural stone material of any length.



Category

SUPERPRO

TRANSPORTABLE

LIGHT



- It makes mitre cuts at 45° up to a maximum thickness of 20 mm, and with no thickness limitation for bevelling.
- Progressive bevelling and mitring at different depths to prolong the useful life of the grinding wheel and make bevelling easier for the user.
- Compatible with 115 & 125mm angle grinders with cable or battery that are easily and safely fitted thanks to the joint made with an M14 threaded shaft and quick-fastening belt.
- Sealed high-speed bearings, to prevent the ingress of dust generated during the bevelling or mitring.
 - Highly wear-resistant polyethylene slides.
 - A vacuum cleaner can be easily fitted for dust extraction (ZERO-DUST).
 - Quick and simple grinding wheel change.
 - Chassis with carbon steel sheet.
 - Highly friction-resistant white polyethylene slides
 - Plastic handle.
 - Sealed single-row deep-groove ball bearings.
 - 45° x 20 mm grinding wheel included (ref. 16946).
 - PVC plastic grinding wheel guard.
 - Fixing to angle grinder by means of a Ø14mm (Ref. 16956) and 5/8"-11" (Ref. 16901) and quick fastening belt.
 - Progressive wear bevelling and mitring is adjustable by 10 mm.
 - A damp cloth is recommended for cleaning.
 - Water is not necessary for use.



	REF.									
PRO-EDGER PORTABLE BEVELING	16956	√	13/16" 20 mm	0" M14 mm	14 15/16x8 1/4x6	9 Lb	9.9 Lb	1	24	
PRO-EDGER PORTABLE BEVELING USA	16901			5/8" 16 mm	11/16" 38x21x17 cm	4.1 kg	4.5 kg			

ACCESSORIES		DESCRIPTION		DESCRIPTION		DESCRIPTION
		Fine Grit PRO-EDGER mitering Wheel		Turbo Twist Coarse Grit PRO-EDGER mitering Wheel		Fine Grit PRO-EDGER bevelling Wheel





ACCESSORIES FOR BEVELLING AND MITRING



◆ SUPERPRO **■ PORCELAIN TILE** **GOOD FINISH**

FINE GRIT PRO-EDGER BEVELLING WHEEL



- Grinding wheel for beveling.
- Diamond grits fixed by means of a vacuum brazing system.
- Recommended for use with ANGLE GRINDERS.
- Recommended use between 9,000 – 12,000 rpm to achieve greater durability of the wheel.
- Round finish available on 5 and 10 mm radius.
- Internal diameter: 16.1 mm (M16 thread).
- For exclusive use with PRO-EDGER.

	REF.				RPM	
FINE GRIT R.5 PRO-EDGER BEVELLING WHEEL	16957	2 5/8" 66 mm	0°	1/4" 6 mm	12000 max.	1
FINE GRIT R.10 PRO-EDGER BEVELLING WHEEL	16958	3" 76 mm	M16 mm	7/16" 11 mm		

◆ SUPERPRO **■ PORCELAIN TILE** **GOOD FINISH**

FINE GRIT PRO-EDGER MITRING WHEEL



- Grinding wheel for mitring.
- Diamond grits fixed by means of a vacuum brazing system.
- Recommended for use with ANGLE GRINDERS.
- Recommended use between 9,000 – 12,000 rpm to achieve greater durability of the wheel.
- 45° type tool with 1-2 mm edge.
- Internal diameter: 16.1 mm (M16 thread).
- For exclusive use with PRO-EDGER.

	REF.				RPM	
45X20 SMOOTH FINE GRIT PRO-EDGER MITRING WHEEL	16946	3 11/16" 94 mm	0°	13/16" 20 mm	12000 max.	1
45X15 SMOOTH FINE GRIT PRO-EDGER MITRING WHEEL	16985	3 5/16" 84 mm	M16 mm	9/16" 15 mm		

◆ SUPERPRO **■ PORCELAIN TILE** **FAST**

TURBO TWIST COARSE GRIT PRO-EDGER MITRING WHEEL



- Grinding wheel for mitring.
- Diamond grits fixed by means of a vacuum brazing system.
- Recommended for use with ANGLE GRINDERS.
- Recommended use between 9,000 – 12,000 rpm to achieve greater durability of the wheel.
- The TURBO TWIST model can be used for grinding before finishing with a fine grit, as its grooved design can chip the tile profile.
- Internal diameter: 16.1 mm (M16 thread).
- For exclusive use with PRO-EDGER.

	REF.				RPM	
TURBO TWIST COARSE GRIT PRO-EDGER MITRING WHEEL 45X15	16984	3 5/16" 84 mm	0° M16 mm	9/16" 15 mm	12000 max.	1





RUBI CLEAR DUST EXTRACTOR M

WET AND DRY VACUUMING WITH THE SAME MACHINE AND SPECIFIC ACCESSORIES FOR OPTIMISATION.

For dry and wet extraction work in areas where very fine dust is generated by cutting, such as hardwood, paint, plastics, cement and brick [type M dust].



Category

PREMIUM

TYPE M CERTIFICATE

AUTOCLEAN



- Autoclean system that automatically shakes the filter.
- M- Class certified, it vacuums up 99.9% of airborne particles, including wood (hard and soft), plaster, plasterboard, Corian, paint, plastics, cement and brick.
- Power socket for automatic start and stop in synchronisation with the tool being used (2000 W max.).
- Metal wheels reinforced with rubber and with an optimum radius for moving on uneven ground.
- Agile and compact. 20L tank and an extra-long handle.
- Included:
- Blue anti-foam filter for vacuuming liquids.
- 3-metre suction hose.
- Extendable plastic tube.
- two multifunctional brush bases.
- Brush for hard floors.
- Brush for working with liquids.
- Flat nozzle for corners.
- Rubber adapter.
- Consumables included:
- Three 20L bags.
- M- Class polyester cartridge filter.

	REF.				
RUBI CLEAR DUST EXTRACTOR M	51941	230V-50Hz.	157 1/2x157 1/2x236 1/4" 400x400x600 cm	22 Lb 10 kg	1
RUBI CLEAR DUST EXTRACTOR M UK	53500	110V-50Hz.			

ACCESSORIES		REF. 51997 RUBI CLEAR DUST EXTRACTOR BAG (5 UN)		REF. 51989 RUBI CLEAR DUST EXTRACTOR FILTER		REF. 52947 CLEAR VACUUM CLEANER WET FILTER



PREMIUM



RUBI CLEAR DUST EXTRACTOR BAG (5 UN)

- Filter bag for M-Class dust extraction.
- Designed specifically for the Clear vacuum cleaner.
- Closure designed for proper waste management and subsequent sealing (regulated in the cleaner's M-Class certification).
- Pack of 5 units.
- IFA certification.

REF.



RUBI CLEAR DUST EXTRACTOR BAG (5 UN)	51997	1
--------------------------------------	-------	---

PREMIUM



RUBI CLEAR DUST EXTRACTOR FILTER

- Filter for dry vacuuming and M- Class filtration.
- Specifically designed for the Clear vacuum cleaner.
- IFA certification.

REF.



RUBI CLEAR DUST EXTRACTOR FILTER	51989	1
----------------------------------	-------	---

PREMIUM



NEW!

CLEAR VACUUM CLEANER WET FILTER

- Filter for wet vacuuming.
- Specifically created for the Clear vacuum cleaner.
- Created to protect the motor.

REF.



CLEAR VACUUM CLEANER WET FILTER	52947	1
---------------------------------	-------	---





AS-30 PRO VACUUM CLEANER

VACUUM ADAPTABLE TO ELECTRIC MACHINES

To vacuum wet or dry.



Category
PRO

EASY HANDLING

LIGHT

- For wet and dry vacuuming.
- Power: 1400 W.
- Airflow: 58 l / s.
- Vacuum: 180 mbar. (18 psi.)
- Capacity: 30 l.
- Double switch: On / Off and automatic start.
- Socket for electric tool (max.2000W)
- Electrical cable: 4 m.
- Accessories included:
 - Hose, nozzle (35/37 mm) and crevice tool.
 - Steel pipes.
 - Wet brush.
 - Filter damp sponge for wet.
 - HEPA filter for dry.

	REF.				
AS-30 PRO VACUUM CLEANER	50962	210-240V/50-60 Hz	25 3/16x14 15/16x14 15/16" 64x38x38 cm	1	9

ACCESSORIES		REF. 50964 AS-30 PRO Vacuum Cleaner Paper Bag.		REF. 50998 AS-30 PRO Vacuum Cleaner Dry Filter		REF. 50999 AS-30 PRO Vacuum Cleaner Wet Filter.

 PRO
**AS-30 PRO VACUUM CLEANER PAPER BAG.**

- Paper bag for dust vacuuming.
- Compatible with AS-30 PRO.
- Biodegradable.
- 4 units set.

REF.

**AS-30 PRO VACUUM CLEANER PAPER BAG.**

50964

1

 PRO
**AS-30 PRO VACUUM CLEANER DRY FILTER**

- HEPA filter for dry vacuuming.
- Compatible with AS-30 PRO.
- Minimum particle size: 5 µm.

REF.

**AS-30 PRO VACUUM CLEANER DRY FILTER**

50998

1

 PRO
**AS-30 PRO VACUUM CLEANER WET FILTER.**

- Filter for wet vacuuming.
- Compatible with AS-30 PRO.
- 2 units set.

REF.

**AS-30 PRO VACUUM CLEANER WET FILTER.**

50999

1





DIAMOND BLADES

Dry cutting diamond blades
Wet cutting diamond blades





DRY CUT

• **WITHOUT NEED OF WATER FOR COOLING.**



SUPERPRO	UNIVERSAL	GENERAL CONSTRUCTION	ALL TERRAIN 4X4
-----------------	------------------	-----------------------------	------------------------

GENERAL PURPOSE SEGMENTED DIAMOND BLADE (STT)

- Recommended blade for cutting all types of building materials, including reinforced concrete. High performance and speed of cutting.
- For cutting materials > 25 mm thickness.

	REF.					RPM	
STT 115 SUPERPRO	30974	4 1/2" 115 mm	7/8" 222 mm	1/16" 2.2 mm	3/8" 10 mm	13300 max.	5
STT 230 SUPERPRO	30976	9" 230 mm				6650 max.	1



PRO	UNIVERSAL	GENERAL CONSTRUCTION	HEAVY DUTY	FAST
------------	------------------	-----------------------------	-------------------	-------------

GENERAL PURPOSE SEGMENTED DIAMOND BLADE (SEV)

- Recommended for cutting building materials such as brick, concrete, terrazzo.
- The fastest. Maximum speed and best blade's cooling. To cut materials with more than 1" (25 mm) thickness.
- Perforated steel blade to improve cooling and diminish cut's tensions.

	REF.					RPM	
SEV 115 PRO	25915	4 1/2" 115 mm	7/8" 22.2 mm	1/16" 1.6 mm	5/16" 8 mm	13300 max.	5
SEV 125 PRO	32940	5" 125 mm		1/16" 2.3 mm		6650 max.	
SEV 230 PRO	25916	9" 230 mm				6650 max.	1



SUPERPRO	PRO	UNIVERSAL CERAMIC	GOOD FINISH
-----------------	------------	--------------------------	--------------------

CERAMIC TILES CONTINUOUS RIM DIAMOND BLADE (CSV)

- Blade for general cut of ceramic tiles as wall tile, floor tiles, porcelain.
- The best finish. To cut ceramic tiles and other stone coating materials with less than 3/4" (20 mm) thickness.

	REF.					RPM	
CSV 115 PRO	25910	4 1/2" 115 mm	7/8" 22.2 mm	1/16" 1.6 mm	5/16" 8 mm	13300 max.	5
CSV 125 PRO	31915	5" 125 mm				12250 max.	
CSV 125 SUPERPRO	30883						



PRO	UNIVERSAL	GENERAL CONSTRUCTION	VERSATILE
------------	------------------	-----------------------------	------------------

GENERAL PURPOSE TURBO DIAMOND BLADE (TSV)

- Recommended for cutting building materials such as bricks, concrete, terrazzo.
- A great combination. High performance and cutting speed with high standard finishes.

	REF.					RPM	
TSV 115 PRO	25917	4 1/2" 115 mm	7/8" 22.2 mm	1/16" 2 mm	5/16"	13300 max.	5
TSV 230 PRO	25918	9" 230 mm		1/8" 2.5 mm	8 mm	6650 max.	1



SUPERPRO	HARD MATERIAL	HEAVY DUTY	FAST
-----------------	----------------------	-------------------	-------------

HARD MATERIALS TURBO DIAMOND BLADE VIPER (TVR)

- Recommended blades to cut hard materials such as granite, slate, quartzite, rustic tiles, klinker and porcelain tile.
- Robust blade, ready to support high tensions in the extremes of the blade.
- For cutting materials > 3/4" (20 mm) thickness.
- High cutting speed.
- Reinforced blade.
- Is suitable for miter cuts.

	REF.					RPM	
TVR 115 SUPERPRO	30986	4 1/2" 115 mm	7/8" 22.2 mm	1/16"	3/8"	13300 max.	5
TVR 125 SUPERPRO	30987	5" 125 mm		14 mm	10 mm	12250 max.	



SUPERPRO	HARD MATERIAL	LONG LIFE	FAST
-----------------	----------------------	------------------	-------------

HARD MATERIALS SEGMENTED DIAMOND BLADE "CANTERO" (SCA)

- Recommended for cutting high hardness natural stones such as granite, basalt, quartzite, concrete drive, etc.
- Long life and high performance. Bar of 12 mm.
- High speed cutting.
- For cutting materials > 25 mm thickness.

	REF.					RPM	
SCA 230 SUPERPRO	30904	9" 230 mm	7/8" 22.2 mm	1/8" 3 mm	1/2" 12 mm	6650 max.	1



SUPERPRO	HARD MATERIAL	FAST	GOOD FINISH
-----------------	----------------------	-------------	--------------------

HARD MATERIALS TURBO VIPER DIAMOND BLADE (TVA)

- Recommended blade for cutting hard materials such as granite, rustic tiles, klinker, refractory, slate, quartzite and porcelain tile.
- The specific design of the diamond band offers greater speed of cutting harder materials without sacrificing finish quality.
- Only for straight cuts, not suitable for mitering.

	REF.					RPM	
TVA 115 SUPERPRO	31932	4 1/2" 115 mm	7/8" 22.2 mm	1/16" 14 mm	3/8" 10 mm	13300 max.	5
TVA 125 SUPERPRO	31933	5" 125 mm		1/16" 16 mm		8500 max.	
TVA 180 SUPERPRO	31934	7" 180 mm	9" 230 mm	1/16" 16 mm	3/8" 10 mm	8500 max.	3
TVA 230 SUPERPRO	31935	9" 230 mm				6650 max.	



NEW!

▲ SUPERPRO

HARD MATERIAL

FAST

GOOD FINISH

HARD MATERIALS TURBO MINI VIPER DIAMOND BLADE (TVA)

- Blade recommended for cutting hard materials such as granite, slate, porcelain stoneware, natural stone and sintered stone, etc.
- Especially for outlet holes.
- Fast cut.
- Long life. Due to the metal alloy of the diamond particle coating, it is resistant to high temperatures which prevents burning of the blade.
- It leaves a very good finish on the tile.
- Only for straight cuts, not suitable for mitre cuts.

	REF.					RPM	
TVA 85 SUPERPRO	32951	3 3/8" 85 mm	7/8" 22.2 mm	1/16" 1.5 mm	3/8" 10 mm	19000 max.	5



NEW!

▲ PRO

PORCELANIC

QUALITY FINISH

FAST

PORCELAIN TILES SLITHER PRO

- Recommended for cutting porcelain material, but it can also cut other materials, such as natural stone, granite or marble.
- Especially suitable for fine cuts with good quality.
- J-Slot type fast disk.
- Not suitable for mitre cutting.

	REF.					RPM	
SLITHER 115 PRO	32953	4 1/2" 115 mm	7/8" 22.2 mm	1/16" 1.5 mm	1/4" 6 mm	13300 max.	5
SLITHER 125 PRO	32954	5" 125 mm				12250 max.	



NEW!

▲ SUPERPRO

PORCELANIC

EXCELLENT QUALITY FINISH

FAST

PORCELAIN TILES SLITHER SUPERPRO

- Recommended for cutting porcelain material, but it can also cut other materials, such as natural stone, granite or marble.
- Especially for VERY fine cuts with EXCELLENT quality.
- J-Slot type fast disk.
- Not suitable for mitre cutting.

	REF.					RPM	
SLITHER 115 SUPERPRO	32960	4 1/2" 115 mm	7/8" 22.2 mm	1/16" 1.5 mm	5/16" 8 mm	13300 max.	5
SLITHER 125 SUPERPRO	32961	5" 125 mm				12250 max.	



◆ SUPERPRO PORCELANIC GOOD FINISH

PORCELAIN TILES CONTINUOUS RIM DIAMOND BLADE (CPR)

- Recommended blade to cut fine porcelain tiles with less than 3/4" (20 mm) thickness.
- The best finish.

	REF.					RPM	
CPR 115 SUPERPRO	30972	4 1/2" 115 mm	7/8" 22.2 mm	1/16" 1.7 mm	5/16" 8 mm	13300 max.	5
CPR 125 SUPERPRO	30973	5" 125 mm				12250 max.	



◆ SUPERPRO PORCELANIC FAST

PORCELAIN TILES TURBO DIAMOND BLADE (TCR)

- Recommended blade to cut fine porcelain tiles.
- High performance and fast cutting speed with high quality finishes.

	REF.					RPM	
TCR 115 SUPERPRO	31972	4 1/2" 115 mm	7/8" 22.2 mm	1/16" 14 mm	5/16" 8 mm	13300 max.	5
TCR 125 SUPERPRO	31973	5" 125 mm				12250 max.	
TCR 180 SUPERPRO	31975	7" 180 mm		1/16" 1.6 mm	5/16" 8 mm	8500 max.	3
TCR 230 SUPERPRO	31978	9" 230 mm		1/16" 2 mm		6650 max.	



◆ SUPERPRO PORCELANIC FAST GOOD FINISH

PORCELAIN TILES J-SLOT DIAMOND BLADE (CPJ)

- For cutting hard porcelain tiles with the best performance.
- Specially recommended for straight cuts and high speed cutting.
- Thanks to J-Slot typology, this disc increases cutting speed on very hard porcelain tiles, while reducing the stresses generated throughout the cut.
- It's original design is for dry cutting, but also allows wet cutting.

	REF.					RPM	
CPJ 115 SUPERPRO	32932	4 1/2" 115 mm	7/8" 22.2 mm	1/16" 1.4 mm	5/16" 8 mm	13300 max.	5
CPJ 125 SUPERPRO	32933	5" 125 mm				12250 max.	



▲ SUPERPRO PORCELANIC EXTRA LONG LIFE FAST LANDSCAPING

PORCELAIN TILES DIAMOND BLADE 2CM (TLG)

- Specially designed for landscaping materials.
- Ideal for dry cutting porcelain, ceramic, natural stone and sintered stone materials of > 20 mm with a grinder.
- A great combination. High performance and cutting speed with high-quality finishes.
- Not suitable for dry cutting with the TC-125 or circular saw.

	REF.					RPM	
TLG 115 EXT SUPERPRO	41900	4 1/2" 115 mm	7/8"	1/16"	3/8"	13300 max.	5
TLG 125 EXT SUPERPRO	41901	5" 125 mm	22.2 mm	14 mm	10 mm	12250 max.	



◆ SUPERPRO **ABRASIVE** **FAST**

ABRASIVE MATERIALS SEGMENTED DIAMOND BLADE (SON)

- Recommended blades to cut abrasive materials such as bricks, calcareous terrazzo, marble, sandstone.

	REF.					RPM	
SON 230 SUPERPRO	32908	9" 230 mm	7/8" 22.2 mm	1/8" 2.6 mm	5/16" 8 mm	6650 max.	1



◆ SUPERPRO **MARBLE** **FAST**

MARBLE ELECTROPLATED DIAMOND BLADE (EMG)

- Recommended electroplated diamond blade to cut marble, limestone and fibers.
- Less vibration. To cut those materials with high risk of breaking, as marble and fibers.

	REF.					RPM	
EMG 115 SUPERPRO	30995	4 1/2" 115 mm	7/8" 22.2 mm	1/16" 2.2 mm	1/8" 3 mm	13300 max.	5



◆ SUPERPRO **METAL, PLASTIC, WOOD** **FAST**

DIAMOND BLADE RESCUE (RSQ)

- Recommended disc for cutting all types of materials including metal, plastic and wood, and more.
- Vacuum Brazed Technology.
- Increased resistance to high temperatures during cutting, reduction of spark generated.
- High speed and performance.

	REF.					RPM	
RSQ 115 SUPERPRO	30900	4 1/2" 115 mm	7/8"	1/8" 2.8 mm	3/16"	13300 max.	5
RSQ 230 SUPERPRO	30902	9" 230 mm	22.2 mm	1/8" 3.0 mm	4 mm	6650 max.	1



◆ SUPERPRO **NO VIBRATIONS** **QUALITY FINISH**

DIAMOND CUTTING & GRINDING (ECD)

- For cutting and grinding soft natural stone and ceramic tiles and synthetic materials.
- For adjustment cuts and grinding on all types of porcelain and hard materials.
- For cutting materials > 3/4" (20 mm) thickness.
- Electroplated continuous rim blade.
- Two-sided and reversible blade for a better performance.
- For grinders use. Connection: M14 thread.

	REF.					RPM	
ECD 115 2IN1 SUPERPRO	31964	4 1/2" 115 mm	0"	1/16"	1/4"	13300 max.	5
ECD 125 2IN1 SUPERPRO	31965	5" 125 mm	M14 mm	18 mm	5.6 mm	12250 max.	



◆ SUPERPRO

HARD MATERIAL

EXTRA LONG LIFE

FAST

DIAMOND CUTTING & GRINDING (TGS)

- Disc for dry finishing cutting and fine grinding.
- For use with porcelain materials and natural stone.
- A great combination. High performance and cutting speed with high-quality finishes.
- Suitable for use with a grinder.

	REF.					RPM	
TGS 115 SUPERPRO	40917	4 1/2" 115 mm	7/8"	1/16"	1"	13300 max.	5
TGS 125 SUPERPRO	40918	5" 125 mm	22.2 mm	1.6 mm	25 mm	12250 max.	



WET CUT

• COOLED WITH WATER.



◆ SUPERPRO	◆ PRO	UNIVERSAL	GENERAL CONSTRUCTION	FAST
------------	-------	-----------	----------------------	------

GENERAL PURPOSE SEGMENTED DIAMOND BLADE (SHR)

- Recommended for cutting building materials such as brick, concrete, terrazzo.
- The fastest. Maximum speed and best blade's cooling. To cut materials with more than 1" (25 mm) thickness.

	REF.	⊘	⊕	⊖	⊗	RPM	📦
SHR 250 PRO	32974	10" 250 mm	1" 25.4 mm	1/8" 2.6 mm	3/8" 10 mm	6150 max.	1
SHR 350 SUPERPRO	32971	14" 350 mm		1/8" 3 mm		4400 max.	



◆ SUPERPRO	◆ PRO	UNIVERSAL CERAMIC	GOOD FINISH
------------	-------	-------------------	-------------

CERAMIC TILES CONTINUOUS RIM DIAMOND BLADE (CEV)

- Blade for general cut of ceramic tiles as wall tile, floor tiles, porcelain.
- The best finish. To cut and mitre ceramic tiles and other stone coating materials with less than 3/4" (20 mm) thickness.

	REF.	⊘	⊕	⊖	⊗	RPM	📦
CEV 180 PRO	25912	7" 180 mm	7/8-1" 22.2 - 25.4 mm	1/16" 1.7 mm	5/16" 8 mm	8500 max.	3
CEV 200 PRO	25913	8" 200 mm				1" 25.4 mm	7650 max.
CEV 250 PRO	25934	10" 250 mm	1/16" 2.2 mm	6150 max.			
CEV 180 SUPERPRO	30945	7" 180 mm	7/8-1" 22.2 - 25.4 mm	1/16" 1.7 mm		8500 max.	3
CEV 200 SUPERPRO	30946	8" 200 mm			1" 25.4 mm	7650 max.	1
CEV 250 SUPERPRO	30949	10" 250 mm	1/16" 2.2 mm	6150 max.			
CEV 300 SUPERPRO	30950	12" 300 mm		3/8" 10 mm	5100 max.		



◆ SUPERPRO	HARD MATERIAL	GOOD FINISH
------------	---------------	-------------

HARD MATERIALS CONTINUOUS RIM DIAMOND BLADE (CPA)

- Recommended for cutting hard materials such granite, rustic tiles, klinker, firebricks or slate.
- The best finish. To cut and mitre ceramic tiles and other stone coating materials with less than 3/4" (20 mm) thickness.

	REF.	⊘	⊕	⊖	⊗	RPM	📦
CPA 180 SUPERPRO	30925	7" 180 mm	7/8" 22.2 mm	1/16" 1.7 mm	5/16" 8 mm	8500 max.	3
CPA 200 SUPERPRO	30926	8" 200 mm				1" 25.4 mm	7650 max.
CPA 250 SUPERPRO	30929	10" 250 mm	1/16" 2.2 mm	6150 max.			
CPA 300 SUPERPRO	30930	12" 300 mm		3/8" 10 mm	5100 max.		
CPA 350 SUPERPRO	30931	14" 350 mm	1/8" 2.6 mm		4400 max.		



▲ SUPERPRO HARD MATERIAL FAST GOOD FINISH

HARD MATERIALS TURBO VIPER DIAMOND BLADE (TVH)

- Recommended blade for cutting hard materials such as granite, rustic tiles, clinker, refractory, slate, quartzite and porcelain tile.
- The specific design of the diamond band offers greater speed of cutting harder materials without sacrificing finish quality.
- For cutting materials > 3/4" (20 mm) thickness.
- Only for straight cuts, not suitable for mitring.

	REF.					RPM	
TVH 200 SUPERPRO	31936	8" 200 mm	1" 25.4 mm	1/16" 1.6 mm	3/8" 10 mm	7650 max.	1
TVH 250 SUPERPRO	31937	10" 250 mm		1/16" 2 mm		6150 max.	
TVH 300 SUPERPRO	31938	12" 300 mm		1/8" 2.4 mm		5100 max.	
TVH 350 SUPERPRO	31939	14" 350 mm				4400 max.	



▲ PRO PORCELANIC GOOD FINISH

PORCELAIN TILES CONTINUOUS RIM DIAMOND BLADE (CPC)

- Recommended blade to cut fine porcelain tiles with less than 3/4" (20 mm) thickness.
- Specially recommended for mitre cutting.

	REF.					RPM	
CPC 180 PRO	30955	7" 180 mm	7/8-1" 22.2 - 25.4 mm	1/16" 1.7 mm	5/16" 8 mm	8500 max.	3
CPC 200 PRO	30956	8" 200 mm	1" 25.4 mm			7650 max.	1
CPC 230 PRO	30958	9" 230 mm	7/8-1" 22.2 - 25.4 mm	1/16" 2 mm		6650 max.	
CPC 250 PRO	30959	10" 250 mm	1" 25.4 mm	1/16" 2.2 mm		6150 max.	
CPC 300 PRO	30960	12" 300 mm		3/8" 10 mm		5100 max.	



▲ PRO PORCELANIC FAST GOOD FINISH

PORCELAIN TILES J-SLOT DIAMOND BLADE (CPX)

- Recommended disc to cut fine porcelain tiles.
- High Tech. High speed on straight cuts on porcelain tiles.

	REF.					RPM	
CPX 200 PRO	30964	8" 200 mm	1" 25.4 mm	1/16" 1.6 mm	5/16" 8 mm	7650 max.	1
CPX 250 PRO	30962	10" 250 mm				6150 max.	
CPX 300 PRO	30963	12" 300 mm				5100 max.	



◆ SUPERPRO **PORCELANIC** **✂ MITRE CUT**

DIAMOND PORCELAIN STONEWARE TURBO MITER (TPI)

- For the miter cut of porcelain tiles. High stability and speed of cut.
- Sintered TURBO blade.
- Laser welding.

	REF.					RPM	
TPI 200 SUPERPRO	31966	8" 200 mm	1" 25.4 mm	1/8" 2.5 mm	5/16" 8 mm	7650 max.	1
TPI 230 SUPERPRO	31967	9" 230 mm				6650 max.	
TPI 250 SUPERPRO	31969	10" 250 mm				6150 max.	



◆ PRO **PORCELANIC** **LANDSCAPING** **LONG LIFE** **FAST**

PORCELAIN TILES DIAMOND BLADE 2CM PRO (TPL)

- Specially designed for landscaping materials.
- Ideal for cutting porcelain, ceramic, natural stone and sintered stone materials of > 20 mm.
- A great combination of high performance and cutting speed with high-quality finishes.
- With holes in the core to help cool the disc and distribute water evenly across the disc.

	REF.					RPM	
TPL 250 EXT PRO	40913	10" 250 mm	1" 25.4 mm	1/16" 1.4 mm	5/16" 8.5 mm	6150 max	1
TPL 300 EXT PRO	40914	12" 300 mm				5100 max	



◆ SUPERPRO **PORCELANIC** **LANDSCAPING** **LONG LIFE** **VERY FAST**

PORCELAIN TILES DIAMOND BLADE 2CM SUPERPRO (SPL)

- Specially designed for landscaping materials.
- Ideal for cutting porcelain, ceramic, natural stone and sintered stone materials of > 20 mm.
- Segmented.
- Due to the diamond rim's special alloy, these types of materials can be cut quickly and have an extra-long life.
- Good finish.

	REF.					RPM	
SPL 250 EXT SUPERPRO	40910	10" 250 mm	1" 25.4 mm	1/16" 1.6 mm	3/8" 10 mm	6150 max.	1
SPL 300 EXT SUPERPRO	40911	12" 300 mm				5100 rpm.	



PREMIUM PORCELANIC LANDSCAPING EXTRA LONG LIFE VERY FAST

PORCELAIN TILES PREMIUM 2CM DIAMOND BLADE (SPT)

- For cutting all types of ceramic, porcelain and natural stone materials.
- For cutting thicknesses from 20 mm to 35 mm.
- Joint by laser welding.
- Extra-long life.
- Suitable for use on cutting tables and cut-off machines that incorporate guard systems in compliance with the standard for use of segmented blades.
- Special bonded alloy that provides a good finish with a very fast cutting speed.

	REF.					RPM	
SPT 250 EXT PREMIUM	32934	10" 250 mm		1/16" 2.2 mm		6150 max.	
SPT 300 EXT PREMIUM	32935	12" 300 mm	1" 25.4 mm	1/8" 2.4 mm	3/8" 10 mm	5100 max.	1
SPT 350 EXT PREMIUM	32936	14" 350 mm				4400 max.	



◆ SUPERPRO ABRASIVE LONG LIFE

ABRASIVE MATERIALS TURBO DIAMOND BLADE (TON)

- Recommended blades to cut abrasive materials such as bricks, calcareous terrazzo, marble, sandstone.
- A great combination. High performance and cutting speed with high standard finishes.

	REF.					RPM	
TON 250 SUPERPRO	31909	10" 250 mm	1" 25.4 mm	1/8" 2.5 mm	5/16" 7.5 mm	6150 max.	1



GENERAL PURPOSE

Recommended blade for cutting concrete and hard materials such as granite, slate, refractory, brick, etc.



GENERAL PURPOSE

Recommended blade for general cutting of building materials such as brick, concrete, terrazzo, natural stone, etc.



GENERAL CERAMIC MATERIAL

Recommended blades for cutting marble, fibers and other materials with high breakage risk.



HARD MATERIALS

Recommended blade for cutting hard materials such as granite, slate, firebrick, etc.



PORCELAIN

Recommended blades for fine cuts of porcelain tiles.



ABRASIVES

Recommended blades for cutting abrasive materials such as bricks, calcareous terrazzo, marble, sandstone, etc.



MARBLE

Recommended blade for cutting marble, limestone and fibres.



RESCUE

Recommended blade for cutting all kinds of materials such as steel sheet, wood, masonry materials, fiberglass, PVC, steel rods, concrete, reinforced concrete, etc ...



CONTINUOUS RIM

The best finish. for cutting and mitering ceramic tiles and other stone coating materials <1" (25mm) thickness.

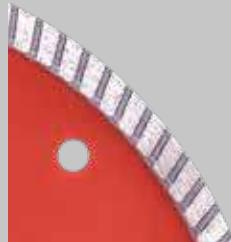

TURBO

A great combination. High performance and speed of cut with high quality finishings.

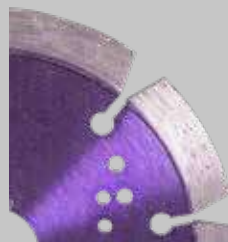

SEGMENTED

The Fastest. Maximum speed and best blade's cooling. To cut materials >1" (25mm) thickness.

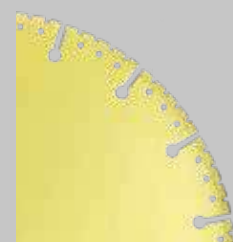

VACUUM BRAZED

The most versatile. Due to his versatility in not petrous materials and cutting speed.

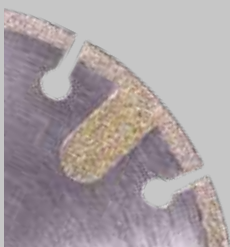

ELECTROPLATED

Less vibration. To cut those materials with high risk of breaking as marble or fibres.



J-SLOT

High-Tech. High speed on hardest materials. Specially designed for straight cuts on porcelain tiles.



VIPER

Best of a TURBO, with the best finishes and cutting speed.



	CONTINUOUS RIM		J-SLOT	TURBO				VIPER			SEGMENTED					ELECTROPLATED		VACUUM BRAZED	
	CSV	CPR	CPJ	TSV	TSA	TCR	TLG	TVR	TVA	MINI TVA	TGS	STT	SEV	SHA	SCA	SON	EMG	ECD	RSQ
CERAMIC TILES	○																		
FIBRE											○						○	○	
GLASS																		○	
GRANITE	○			○	○		○	○	○		○	○	○	○	○				
HARD STONE	○			○	○			○	○	○			○	○	○				
LANDSCAPING							○	○			○								
MARBLE	○			○							○	○			○	○	○		
PORCELAIN TILES	○	○	○			○	○	○	○		○							○	
ABRASIVE MATERIAL				○								○	○			○			○
SLATE				○	○		○	○	○			○	○	○	○	○		○	○
CONCRETE				○								○	○			○			
PLASTIC																			○
WOOD																			○
METAL																			○

Optimal Use ○
Alternative Use ○



-  CERAMIC TILES
-  FIBRE
-  GLASS
-  GRANITE
-  HARD STONE
-  LANDSCAPING
-  MARBLE
-  PORCELAIN TILES
-  ABRASIVE MATERIAL
-  SLATE
-  CONCRETE
-  PLASTIC
-  WOOD
-  METAL

	CONTINUOUS RIM			J-SLOT	TURBO			VIPER	SEGMENTED		
	CEV	CPA	CPC	CPX	TON	TPI	TPL	TVH	SPL	SHR	SPT
CERAMIC TILES	○										
FIBRE					○					○	
GLASS			○								
GRANITE	○	○					○	○	○	○	○
HARD STONE		○						○			
LANDSCAPING							○		○		○
MARBLE	○				○					○	
PORCELAIN TILES	○	○	○	○		○	○	○	○		○
ABRASIVE MATERIAL					○					○	
SLATE		○					○	○	○	○	○
CONCRETE					○					○	
PLASTIC											○
WOOD											○
METAL											○

Optimal Use ○
Alternative Use ◌





DRILLING

Tools for drilling ceramic tile, stoneware, marble, granite and other materials.



TUNGSTEN CARBIDE DRILL BITS

- TUNGSTEN CARBIDE BITS FOR DRILLING WALL TILES.
- ADAPTABLE TO HEAD FOR ELECTRIC DRILL WITHOUT HAMMER.



▲ PRO
■ CERAMIC TILE
🔧 ELECTRIC DRILL WITHOUT PERCUSSION

TUNGSTEN CARBIDE DRILL BITS

- Tungsten carbide drill bits for wall tiles. Adaptable to head for use with electric drill without hammer (ref. 04992).

	REF.	RPM			
DRILL BIT 1 3/8" (35 MM.)	04962	800 max.	11/16" 18 mm	5	780
DRILL BIT 1 3/4" (45 MM.)	04964				
DRILL BIT 2 1/4" (55 MM.)	04965				

▲ PRO



HEAD AND CENTRAL ATTACHMENT DRILL BIT

- Attachable to all measures of Tungsten Carbide drill bits.
- Supplied in blister.

	REF.	
HEAD WITH CENTRAL ATTACHMENT DRILL BIT	04992	1



DIAMOND DRILL BITS - DRY CUT

• FOR DRY DRILLING OF WALL TILES, FLOOR TILES AND PORCELAIN TILES.



 SUPERPRO







 PORCELAIN TILE

 GRINDER

 ELECTRIC DRILL
WITHOUT PERCUSSION

DRYGRES DRILL BITS

- For dry drilling in ceramic, porcelain, natural stone and other materials.
- Maximum operating speed 14,000 r.p.m. M14 thread finish.
- They can be used both with grinders or drill without hammer, using the included adapter kit.
- Usable with grinder. Supplied in blister.

	REF.	RPM		
DRYGRES DRILL BIT Ø 1/4" [6 MM.]	05988	14000 max.		
DRYGRES DRILL BIT Ø 2/7" [7 MM.]	05994			
DRYGRES DRILL BIT Ø 5/16" [8 MM.]	05989			
DRYGRES DRILL BIT Ø 3/8" [10 MM.]	05990			
DRYGRES DRILL BIT Ø 1/2" [12 MM.]	05991			
DRYGRES DRILL BIT Ø 3/4" [20 MM.]	04910			
DRYGRES DRILL BIT Ø 1" [25 MM.]	57903	14000		
DRYGRES DRILL BIT Ø 1 1/8" [28 MM.]	04911	14000 max.		
DRYGRES DRILL BIT Ø 1 3/8" [35 MM.]	04912			
DRYGRES DRILL BIT Ø 1 3/4" [43 MM.]	04913			
DRYGRES DRILL BIT Ø 2" [50 MM.]	04914			
DRYGRES DRILL BIT Ø 2 3/8" [60 MM.]	04915			
DRYGRES DRILL BIT Ø 2 1/2" [65 MM.]	04916			
DRYGRES DRILL BIT Ø 2 11/16" [68 MM.]	04917			
DRYGRES DRILL BIT Ø 3" [75 MM.]	05992			
DRYGRES DRILL BIT Ø 3 1/8" [80 MM.]	57904	14000		
DRYGRES DRILL BIT Ø 3 1/4" [85 MM.]	57906			
DRYGRES DRILL BIT Ø 4" [100 MM.]	57907			
DRYGRES DRILL BIT Ø 4 3/4" [120 MM.]	57908			



SUPERPRO
PORCELAIN TILE
GRINDER
ELECTRIC DRILL WITHOUT PERCUSSION

KIT DRYGRES

- They can be used both with grinders or drill without hammer, using the included adapter kit.
- The kit includes:
- MULTIDRILL guide with carry case .Ref.50917, Ref.50936, Ref.50996
- Dry cutting diamond drill bits:
- Ø1 1/8" (28mm), 1 3/8" (35mm), 1 3/4" (43mm) & 2 11/16" (68mm).
- Ø1 1/8" (28mm), 1 3/8" (35mm), 1 3/4" (43mm), 2" (50mm) & 2 11/16" (68mm).
- Ø1/4" (6mm), 5/16" (8mm), 3/4" (20mm), 1 3/8" (35mm), 5/8" & 2 11/16" (68mm).

	REF.	RPM		
KIT 4 BITS DRYGRES	50917	14000 max.	17/16" 36 mm	1
KIT 5 BITS DRYGRES	50936			
KIT 6 BITS DRYGRES	50996			



SUPERPRO
PORCELAIN TILE
GRINDER
ELECTRIC DRILL WITHOUT PERCUSSION

KIT MINI DRYGRES

- Dry cutting diamond drill bits for drilling porcelain tiles, glazed tiles, natural stone and other ceramics.
- They can be used both with grinders or drill without hammer, using the included adapter kit.
- Kit includes:
- Drill Ø 1/4" (6 mm), 5/16" (8 mm), 3/8" (10 mm) and 1/2" (12 mm).
- Case.

	REF.	RPM		
KIT MINI DRYGRES	50938	14000 max.	17/16" 36 mm	1



SUPERPRO
PORCELAIN TILE
GRINDER
ELECTRIC DRILL WITHOUT PERCUSSION

KIT TCR BLADE AND DRYGRES DRILL BITS

- They can be used both with grinders or drill without hammer, using the included adapter kit.
- Kit includes:
- Dry diamond cutting disc TCR-115.
- Four dry cutting diamond drill bits (2x6mm, 20mm, 35mm)(2x1/4", 13/16", 1 3/8").

	REF.	
KIT TCR BLADE AND DRYGRES DRILL BITS	68923	1

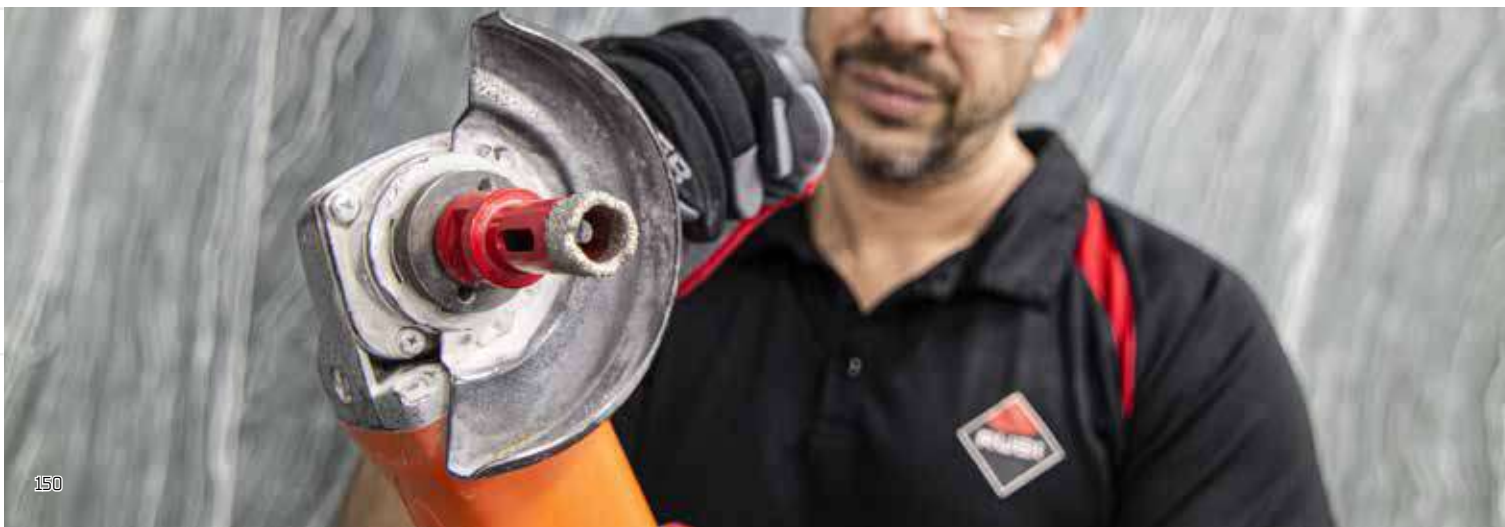



PREMIUM



PORCELAIN TILE
EXTRA LONG LIFE

GRINDER

ELECTRIC DRILL WITHOUT PERCUSSION

DRYGRES PREMIUM DRILL BITS

- Designed for the fast drill of any kind of ceramic tiles including porcelain, but also suitable to drill natural stone as granite or marble, and sintered stone.
- Vacuum brazed type drill bits that provides a very fast dry drilling with very good quality.
- Resistant brazed of diamond grits and great quality materials for extra long life.
- Integrated wax only in the smallest diameters (6 – 12 mm) to help cooling and lubrication during drilling.
- Side openings for better cooling due to greater air circulation in biggest diameters (20 – 85 mm).
- Air cooled through the own rotation but also recommended to use small orbital movements with the tool to help cooling.
- They can be used both with grinders or drill without hammer, using the included adapter kit.

	REF.	RPM		
DRYGRES PREMIUM DRILL BITS Ø 6 MM.	06900	14000	1 3/16" 30 mm	1
DRYGRES PREMIUM DRILL BITS Ø 7 MM.	06915			
DRYGRES PREMIUM DRILL BITS Ø 8 MM.	06918			
DRYGRES PREMIUM DRILL BITS Ø 10 MM.	06919			
DRYGRES PREMIUM DRILL BITS Ø 12 MM.	06929			
DRYGRES PREMIUM DRILL BITS Ø 20 MM.	06971			
DRYGRES PREMIUM DRILL BITS Ø 28 MM.	06972		1 1/2" 38 mm	
DRYGRES PREMIUM DRILL BITS Ø 35 MM.	06973			
DRYGRES PREMIUM DRILL BITS Ø 43 MM.	06974			
DRYGRES PREMIUM DRILL BITS Ø 50 MM.	06975			
DRYGRES PREMIUM DRILL BITS Ø 60 MM.	06976			
DRYGRES PREMIUM DRILL BITS Ø 65 MM.	06977			
DRYGRES PREMIUM DRILL BITS Ø 68 MM.	06978			
DRYGRES PREMIUM DRILL BITS Ø 75 MM.	06979			
DRYGRES PREMIUM DRILL BITS Ø 85 MM.	06980			



PREMIUM

PORCELAIN TILE
EXTRA LONG LIFE

GRINDER

ELECTRIC DRILL WITHOUT PERCUSSION

KIT DRYGRES PREMIUM

- They can be used both with grinders or drill without hammer, using the included adapter kit.
- The kit includes:
 - MULTIDRILL guide with carry case. Ref.51931, Ref.51937, Ref.51929
 - Dry cutting diamond drill bits:
 - Ø1 1/8"(28mm), 1 3/8"(35mm), 1 3/4"(43mm) & 2 11/16"(68mm).
 - Ø1 1/8"(28mm), 1 3/8"(35mm), 1 3/4"(43mm), 2"(50mm) & 2 11/16"(68mm).
 - Ø1/4"(6mm), 5/16"(8mm), 3/4"(20mm), 1 3/8"(35mm), 50 & 2 11/16"(68mm).

	REF.	RPM	
KIT 4 DRILL BITS DRYGRES PREMIUM	51931	14000	1
KIT 5 DRILL BITS DRYGRES PREMIUM	51937		
KIT 6 DRILL BITS DRYGRES PREMIUM	51929		



PREMIUM
PORCELAIN TILE
EXTRA LONG LIFE
GRINDER
ELECTRIC DRILL WITHOUT PERCUSSION

KIT MINI DRYGRES PREMIUM

- Dry cutting diamond drill bits for drilling porcelain tiles, glazed tiles, natural stone and other ceramics.
- They can be used both with grinders or drill without hammer, using the included adapter kit.
- Kit includes:
 - Drill Ø 1/4" (6 mm), 5/16" (8 mm), 3/8" (10 mm) and 1/2" (12 mm).
 - Case.

	REF.	RPM	
KIT MINI DRYGRES PREMIUM	51939	14000	1



SUPERPRO
PORCELAIN TILE
LONG LIFE
CORDLESS POWER DRILL

DRYGRES DRILL BITS 4DRILL

- Specially designed for dry drilling in porcelain stoneware. Suitable for other ceramic materials, natural stone and artificial stone.
- With high resistant welding of the diamond grains for a longer duration.
- "Easy-Start" Without slipping. Suitable for work without a centering guide.
- Perfect for cordless drills (1000 - 2500 rpm).
- Reinforced body with grub screw for better performance and rigidity, thus maintaining the wax on the tip of the drill (no wax Ø28 & Ø35 mm models).
- High quality finish.
- Designed to be used exclusively with either a cordless drill or an electric drill.
- Their hexagonal connection allows them to adapt quickly to drills with a 10 mm chuck.

	REF.	RPM		
DRYGRES DRILL BITS 4DRILL Ø 1/4" [6 MM.]	05923	1000 min.	17/16" 36 mm	1
DRYGRES DRILL BITS 4DRILL Ø 5/16" [8 MM.]	05924			
DRYGRES DRILL BITS 4DRILL Ø 3/8" [10 MM.]	05926			
DRYGRES DRILL BITS 4DRILL Ø 1/2" [12 MM.]	05927			
DRYGRES DRILL BITS 4DRILL Ø 9/16" [14 MM.]	05928	2000 min.	19/16" 40 mm	
DRYGRES DRILL BITS 4DRILL Ø 3/4" [20 MM.]	05929			
DRYGRES DRILL BITS 4DRILL Ø 1 1/8" [28 MM.]	05970			
DRYGRES DRILL BITS 4DRILL Ø 1 3/8" [35 MM.]	05971			



SUPERPRO
PORCELAIN TILE
LONG LIFE
CORDLESS POWER DRILL

KIT DRYGRES 4DRILL

- For dry drilling in porcelain stoneware. Suitable for other ceramic materials, natural stone and artificial stone.
- Hexagonal connection, compatible with battery drills.
- Kit composed of:
 - DRYGRES 4DRILL diamond drills dry cut Ø 6, 8, 10 and 12 mm.
- With case.

	REF.	RPM	
KIT DRYGRES 4DRILL	05939	1000 min.	1



NEW!



◆ SUPERPRO **■ PORCELAIN TILE** **LONG LIFE** **GOOD FINISH** **LANDSCAPING**

DIAMOND GRINDING BITS

- Suitable for working with natural stone and porcelain.
- To enlarge or modify the diameter and shape of a previously made hole.
- Can also be used for smoothing, polishing or cleaning the interior edges of these holes.
- For dry use with M14 thread grinders.
- High diamond quality and concentration for a long useful life.
- Diamond fixed by means of a vacuum brazing process.
- Provides a good finish thanks to its #50-60 grit size.
- Stable performance with minimum deviation.
- The diamond grinding bits ARE NOT SUITABLE for making holes.

	REF.	RPM			
CYLINDRICAL BIT Ø 10 MM	06984	11000 max.	1 15/16" 50 mm	0.22 Lb	1
CYLINDRICAL BIT Ø 20 MM	06985			0.33 Lb	
CONICAL BIT Ø 2-35 MM	06986		1 3/8" 35 mm	0.15 kg	
CONICAL BIT Ø 20-48 MM	06987		1 1/4" 32 mm	0.26 Lb	

DIAMOND DRILL BITS - WET CUT

• FOR WET DRILLING OF WALL TILES, FLOOR TILES, PORCELAIN AND OTHER MATERIALS.



◆ SUPERPRO **■ PORCELAIN TILE** **EXTRA LONG LIFE** **⚡ ELECTRIC DRILL WITHOUT PERCUSSION**

FORAGRES DRILL BITS Ø 13/16" TO 4 3/4" (20 - 120 MM.)

- To drill floor tiles, porcelain tiles, granite and marble.
- Always use cooled with water and non-hammer electric drill.
- Ø 1 5/8" (40 mm.) drill bit, designed for housing of toilet flushing mechanisms. Supplied in blister.



	REF.	RPM		
FORAGRES DRILL BIT 3/4" (20 MM.)	04970	900 max.	1 3/16" 30 mm	1
FORAGRES DRILL BIT 1 1/8" (28 MM.)	04971			
FORAGRES DRILL BIT 1 3/8" (35 MM.)	04972			
FORAGRES DRILL BIT 1 5/8" (40 MM.)	04963			
FORAGRES DRILL BIT 2" (50 MM.)	04973			
FORAGRES DRILL BIT 2 1/2" (65 MM.)	04974			
FORAGRES DRILL BIT 2 11/16" (68 MM.)	04918			
FORAGRES DRILL BIT 3" (75 MM.)	04975	450 max.	1 5/16" 33 mm	1
FORAGRES DRILL BIT 4" (100 MM.)	04976			
FORAGRES DRILL BIT 4 3/4" (120 MM.)	04977			



SUPERPRO
PORCELAIN TILE
EXTRA LONG LIFE
ELECTRIC DRILL WITHOUT PERCUSSION

KIT FORAGRES

- Kit includes:
- MULTIDRILL Guide.
- Tank and hose.
- Diamond drill bits Ø 3/4", 1 1/8", 1 3/8", 1 3/4", 2" and 2 11/16" (Ø 20, 28, 35, 43, 50, 68 mm).
- Case.

	REF.	RPM		
KIT FORAGRES	50903	900 max.	1 3/16" 30 mm	1



PRO
PORCELAIN TILE
ELECTRIC DRILL WITHOUT PERCUSSION

EASY GRES DRILL BITS

- Diamond drill bits to be used with electric drill without hammer.
- The quality of the diamond allows the drilling of ceramics, porcelain, granite, marble and glass.
- Ideal to install bathroom accessories and any type of decorative accessories over ceramic surfaces.
- They must always be used with the EASY GRES guide which allows their adequate refrigeration ensuring a high accuracy and good results.
- Body made of steel and bit made of electrodeposited diamond.
- Lateral opening to improve cooling of the drill bit and to allow the elimination of solid waste produced after the drilling of the hole.
- Recommended speed of use between 400 and 1000 r.p.m. depending of the material to be drilled.
- To achieve a better finish and a longer life of the drill bit, it's important to observe the adequate speed of use and to apply a moderate pressure during the drilling.
- Supplied in blister.

	REF.	RPM			
EASY GRES DRILL BIT 7/32" [6 MM.]	04922	1000 max.	1" 25 mm	10	4600
EASY GRES DRILL BIT 1/4" [6.5 MM.]	04920				
EASY GRES DRILL BIT 5/16" [8 MM.]	04923				
EASY GRES DRILL BIT 3/8" [10 MM.]	04924				
EASY GRES DRILL BIT 1/2" [12 MM.]	04921				
EASY GRES DRILL BIT 3/4" [20 MM.]	05961	500 max.	1 1/16" 27 mm	1	
EASY GRES DRILL BIT 1 1/8" [28 MM.]	05962				
EASY GRES DRILL BIT 1 3/8" [35 MM.]	05963				
EASY GRES DRILL BIT 1 5/8" [40 MM.]	05964				
EASY GRES DRILL BIT 1 3/4" [43 MM.]	05965				
EASY GRES DRILL BIT 2" [50 MM.]	05966				
EASY GRES DRILL BIT 2 1/4" [55 MM.]	05967				
EASY GRES DRILL BIT 2 1/2" [65 MM.]	05969				
EASY GRES DRILL BIT 2 11/16" [68 MM.]	05978				
EASY GRES DRILL BIT 3" [75 MM.]	05979				
EASY GRES DRILL BIT 4" [100 MM.]	05981				
EASY GRES DRILL BIT 4 3/4" [120 MM.]	05982				





 PRO

 PORCELAIN TILE

 ELECTRIC DRILL
WITHOUT PERCUSSION

EASY GRES DRILL BIT SETS Ø 7/32" TO 1/2" (6 - 12 MM.)

- The EASY GRES guide allows holes both vertically and horizontally, thanks to its functional design incorporating a water tank with flow control valve.
- The EASY GRES guide attaches easily to any surface, thanks to its renewable adhesives.

	REF.	RPM			
EASY GRES DRILL BIT 7/32" (6 MM.) SET	04927	1000 max.	1" 25 mm	10	800
EASY GRES DRILL BIT 5/16" (8 MM.) SET	04928				
EASY GRES DRILL BIT 3/8" (10 MM.) SET	04929				
EASY GRES DRILL BIT 1/4" AND 3/8" (6.5 AND 10 MM.) SET	04909				
KIT EASY GRES BITS Ø 6,8,10 AND 12 MM .	04904	1000			





 PRO

 PORCELAIN TILE

 ELECTRIC DRILL
WITHOUT PERCUSSION

KIT EASY GRES PLUS

- The kit includes:
- MULTIDRILL guide.
- Water tank and hose.
- EASY GRES drills Ø 3/4", 1 1/8", 1 3/8", 1 3/4", 2", 2 1/2" and 3" (20, 28, 35, 43, 50, 65 and 75 mm.) and case.

	REF.	RPM			
KIT EASY GRES PLUS	50937	500 max.	1 1/16" 27 mm	1	48





 PRO

 PORCELAIN TILE

 ELECTRIC DRILL
WITHOUT PERCUSSION

EASY GRES DRILL BIT Ø 1 3/8" (35 MM.) SET

- The kit includes:
- MULTIDRILL guide.
- Water tank and hose.
- EASY GRES drill bit Ø 1 3/8" (35 mm).

	REF.	RPM			
EASY GRES DRILL BIT Ø 1 3/8" (35 MM.) SET	50921	500 max.	1 1/16" 27 mm	1	720

ACCESSORIES FOR DIAMOND DRILL BITS

• GUIDANCE SYSTEMS, AND OTHER ACCESSORIES FOR DIAMOND DRILLS.

2
Cut & Drill

PRO

TANK FOR MULTIDRILL GUIDE

- Bottle of 1200 ml. volume, with manual pressure pump.
- Includes 2 m. hose.

	REF.	
TANK AND HOSE FOR MULTIDRILL GUIDE	50947	1

PRO

MULTIDRILL GUIDE

- By fixing with suction cup, allows horizontal and vertical holes in the right place, preventing the drill bit from slipping.
- Compatible with all Rubi diamond drill bits, Ø 6 to 83 mm.
- Includes hose and tank connection (Ref. 50947).

	REF.	
MULTIDRILL GUIDE	50944	1

PRO

MULTIDRILL PLUS RM GUIDE

- By fixing the guide with the suction cup, allows horizontal and vertical holes in the correct place, preventing the drill bit from slipping on any type of surface: smooth, rough or slightly structured.
- Compatible with all Rubi diamond drill bits, Ø 6 to 120 mm.
- Metal centering guide for greater wear resistance.
- Includes hose and tank connection (Ref. 50947).

	REF.	
MULTIDRILL PLUS GUIDE RM (MAX. Ø 120 MM)	51908	1

SUPERPRO

ELECTRIC DRILL ADAPTER

- For the use of dry cutting diamond drill bit with electric drill. (M14)
- Use without hammer.



	REF.	
M14 ADAPTER FOR ELECTRIC DRILL	05976	1



DRILL BIT CHARACTERISTICS

		REF	Ø MM	Ø INCH	RPM	mm	inch	USE		
DIAMOND DRILL BITS	FORAGRES	Tile, Ceramic tiles, Porcelain tiles, Granite, Marble	04970	20	3/4"	max. 900	30	1 3/16"	 ELECTRIC DRILL Without percussion USE with Multidrill drilling guide / MULTIDRILL PLUS RM. + Water tank and hose (Ref. 50944/51908 + 50947)	
			04971	28	1 1/8"					
			04972	35	1 3/8"					
			04963	40	1 5/8"					
			04973	50	2"					
			04974	65	2 1/2"					
			04918	68	2 11/16"					
			04975	75	3"					
			04976	100	4"					
			04977	120	4 3/4"					
		EASYGRES	Tile, ceramic Tiles, Porcelain tiles, Granite, Marble, Glass	04927	6	14/64"	Between 400 & 1.000	25	1"	 ELECTRIC DRILL Without percussion USE with Multidrill drilling guide + Water tank and hose (Ref. 50944 + 50947)
	04925			6,5	1/4"					
	04928			8	5/16"					
	04929			10	13/32"					
	04926			12	1/2"					
	05961			20	3/4"					
	05962			28	1 1/8"					
	05963			35	1 3/8"					
	05964			40	1 5/8"					
	05965			43	1 3/4"					
	05966	50	2"							
	05967	55	2 1/4"							
	05969	65	2 1/2"							
	05978	68	2 11/16"							
	05979	75	3"							
	05981	100	4"							
	05982	120	4 3/4"							
		BULL NOSE	Porcelain, Natural Stone and Landscaping Materials	52938	20	13/16"	max. 14.000	20	13/16"	 GRINDER
52939	R10			3/8"						
	CONICAL	Porcelain and Natural Stone	06986	2-35	1 1/16" - 1 3/8"	max. 11.000	32	1 1/4"		
06987			20-48	13/16" - 1 7/8"						
06984			10	3/8"						
06985			20	13/16"						



		REF	Ø MM	Ø INCH				USE			
DIAMOND DRILL BITS	DRYGRES PREMIUM	Tile, Ceramic tiles, Porcelain tiles, Granite, Marble		06900	6	14/64"	max. 14.000	 GRINDER ELECTRIC DRILL Without percussion MULTIDRILL GUIDE / MULTIDRILL PLUS RM			
		06915	7	1/4"							
		06918	8	5/16"							
		06919	10	13/32"							
		06929	12	1/2"							
		06971	20	3/4"							
		06972	28	1 1/8"							
		06973	35	1 3/8"							
		06974	43	1 3/4"							
		06975	50	2"							
		06976	60	2 3/18"							
		06977	65	2 1/2"							
		06978	68	2 11/18"							
		06979	75	3"							
		06980	85	3 3/8"							
		DRYGRES	Tile, Ceramic tiles, Porcelain tiles, Granite, Marble		05988	6	14/64"	max. 14.000	 GRINDER ELECTRIC DRILL Without percussion Use with adapter (Ref. 05976) MULTIDRILL GUIDE / MULTIDRILL PLUS RM		
	05994		7	1/4"							
	05989		8	5/16"							
	05990		10	13/32"							
	05991		12	1/2"							
	04910		20	3/4"							
	57903		25	1"							
	04911		28	1 1/8"							
	04912		35	1 3/8"							
	04913		43	1 3/4"							
	04914		50	2"							
	04915		60	2 3/18"							
	04916		65	2 1/2"							
	04917		68	2 11/18"							
	05992		75	3"							
		DRYGRES 4DRILL	Coating ceramics, Ceramic tiles, Porcelain tiles, Natural Stone, Piedra Artificial		05923	6	14/64"	min. 1.000	 ELECTRIC DRILL Without percussion Without percussion and adapter (Ref. 04992)		
	05924		8	5/16"							
	05926		10	13/32"							
	05927		12	1/2"							
	05928		14	9/16"							
05929	20		3/4"								
05970	28		1 1/8"								
05971	35		1 3/8"								
	TUNGSTEN CARBIDE DRILL BITS		Tile		04962	35	1 3/8"			max. 800	 ELECTRIC DRILL Without percussion Without percussion and adapter (Ref. 04992)
04964			45	1 3/4"							
04965		55	2 1/4"								
04968		85	3 1/4"								



GRINDING & POLISHING

Grinding wheels and blades
Blades and polishing pads



GRINDING WHEELS



SUPERPRO

CONCRETE

LONG LIFE

CONCRETE DOUBLE ROW GRINDING CUP

- Grinding cup with double row of sintered segments for grinding and edge finishing on concrete surfaces.
- Laser welding. Coarse grinding finish. Heavy-Duty steel core.
- For GRINDERS use.
- Maximum perimeter speed: 15.300 RPM (Ref. 05917) and 12.250 RPM (Ref. 05918).

	REF.					RPM	
GRINDING CUP WHEEL CONCRETE DOUBLE ROW Ø100	05917	4" 100 mm	7/8"	1/4"	3/4"	15300 max	1
GRINDING CUP WHEEL CONCRETE DOUBLE ROW Ø125	05918	5" 125 mm	22.2 mm	6 mm	19 mm	12250 max	1

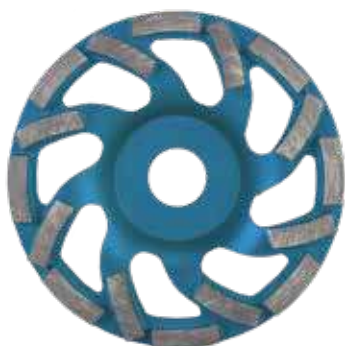

SUPERPRO

CONCRETE

FAST

CONCRETE FAN GRINDING CUP

- Fan shaped grinding cup with sintered segments for fast grinding and edge finishing on concrete surfaces.
- Laser welding. Coarse grinding finish. Heavy-Duty steel core.
- For GRINDERS use.
- Maximum perimeter speed: 15.300 RPM (Ref. 05919) and 12.250 RPM (Ref. 05920)

	REF.					RPM	
GRINDING CUP WHEEL CONCRETE FAN CUP Ø100	05919	4" 100 mm	7/8"	3/16"	15/16"	15300 max	1
GRINDING CUP WHEEL CONCRETE FAN CUP Ø125	05920	5" 125 mm	22.2 mm	5 mm	23.5 mm	12250 max	1



SUPERPRO

NATURAL STONE

LONG LIFE

STONE GRINDING CUP

- Turbo sintered grinding cup for grinding and edge finishing on natural stone surfaces.
- Laser welding. Coarse grinding finish. Heavy-Duty steel core.
- For GRINDERS use.
- Maximum perimeter speed: 15.300 RPM (Ref. 05919) and 12.250 RPM (Ref. 05920).

	REF.					RPM	
GRINDING CUP WHEEL TURBO STONE Ø100	05921	4" 100 mm	0" M14 mm	1/4"	3/4"	15300 max	1



SUPERPRO

EPOXY

EPOXY-FIBRE GRINDING CUP

- PCD grinding cup for fast removal of epoxy, paint, acrylics or other elastic coatings.
- High frequency welding. Heavy-Duty steel core. Medium grinding finish.
- For GRINDING use.
- Maximum perimeter speed: 12.250 RPM

	REF.					RPM	
GRINDING CUP WHEEL EPOXY, FIBRE, PCD Ø125	05922	5" 125 mm	7/8"	1/16"	7/16"	12250 max	1

CUTTING & GRINDING BLADES









◆ SUPERPRO

NO VIBRATIONS

GOOD FINISH

CUTTING & GRINDING BLADES

- For cutting and grinding soft natural stone and ceramic tiles and synthetic materials.
- For adjustment cuts and grinding on all types of porcelain and hard materials.
- For materials with <25 mm thickness.
- Electroplated continuous rim blade.
- Two-sided and reversible blade for a better performance.
- For grinders use. Connection: M14 thread.

	REF.						RPM	
ECD 115 2IN1 SUPERPRO	31964	4 1/2" 115 mm	0"	1/16"	1/4"	1"	13300 max	1
ECD 125 2IN1 SUPERPRO	31965	5" 125 mm		M14 mm	18 mm	5.6 mm	25 mm	



◆ SUPERPRO





HARD MATERIAL

EXTRA LONG LIFE

FAST

CUTTING & GRINDING BLADES (TGS)

- Disc for dry finishing cutting and fine grinding.
- For use with porcelain materials and natural stone.
- A great combination. High performance and cutting speed with high-quality finishes.
- Suitable for use with a grinder.

	REF.					RPM	
TGS 115 SUPERPRO	40917	4 1/2" 115 mm	7/8"	1/16"	1"	13300 max.	5
TGS 125 SUPERPRO	40918	5" 125 mm		22.2 mm	1.6 mm	25 mm	



GRINDING CUTTERS



◆ SUPERPRO
■ PORCELAIN TILE
QUALITY FINISH
LONG LIFE
LANDSCAPING

ROUND GRINDING CUTTERS

- For round edge grinding on porcelain, natural stone and landscaping materials.
- These cutters can easily produce bevels on worktops, steps, swimming pool coping, tree surrounds, kerbs, etc.
- For use with a grinder with M14 fitting.
- Diamond fixed by means of a vacuum brazing process.

	REF.		RPM			
FULL BULL NOSE	52938	1 15/16" 50 mm	14000 max.	13/16" 20 mm	101 Lb 0.46 kg	1



◆ SUPERPRO
■ PORCELAIN TILE
QUALITY FINISH
LONG LIFE
LANDSCAPING

BULLNOSE GRINDING CUTTERS

- For round-edge grinding on porcelain, natural stone and landscaping materials.
- These cutters can easily produce bevels on skirting, steps, worktops, swimming pool coping, etc.
- For use with a grinder with M14 fitting.
- Diamond fixed by means of a vacuum brazing process.

	REF.		RPM			
HALF BULL NOSE	52939	1 15/16" 50 mm	14000 max.	13/16" 20 mm	0.97 Lb 0.44 kg	1



DIAMOND FLAP DISCS



NEW!

◆ SUPERPRO

■ PORCELAIN TILE



FAST

GOOD FINISH

LONG LIFE

DIAMOND FLAP DISCS

- For grinding ceramic, porcelain, sintered stone and natural stone.
- Fast grinding with a long life due to the ratio of diamond concentration to diamond grit spacing.
- Excellent for mitres and bevels.
- Ideal for edge and surface grinding.
- It comes with an aluminium M14 ADAPTER for use with the grinder to reduce vibrations and provide better stability during work.
- Electroplated.
- Dry and wet grinding.
- Very good finish.

	REF.		RPM		
DIAMOND FLAP DISC 50/60 COARSE GRIT Ø115	32921	4 1/2" 115 mm	10500	0.93 Lb 0.42 kg	1
DIAMOND FLAP DISC 100/120 MEDIUM GRIT Ø115	32927				
DIAMOND FLAP DISC 200 FINE GRIT Ø115	32931				
DIAMOND FLAP DISC 50/60 COARSE GRIT Ø125	32937	5" 125 mm	9650		
DIAMOND FLAP DISC 100/120 MEDIUM GRIT Ø125	32938				
DIAMOND FLAP DISC 200 FINE GRIT Ø125	32939				

GRINDING & POLISHING



PRO

PORCELAIN TILE

GRINDING BLADES

- VACUUM BRAZED embossed plate.
- For edges and surfaces grinding of natural stone, all kind of ceramic tiles and paint or resin coatings.
- For GRINDERS use.
- Maximum recommended speed: 15,300 RPM.
- Fine grinding finish (Ref.31974).
- Coarse grinding finish (Ref.31979).

	REF.					RPM	
VDF 100 FINE PRO	31974	4"	7/8"	1/16" 2.1 mm	7/8"	15300 max	1
VDF 100 COARSE PRO	31979	100 mm	22.2 mm	1/8" 2.4 mm	23 mm		

BEVELING WHEELS



SUPERPRO

PORCELAIN TILE

GOOD FINISH

FINE GRAIN PRO-EDGER BEVELING WHEEL

- Grinding wheel for bevelling.
- Diamond grits fixed by means of a vacuum brazing system.
- Recommended use between 9,000 – 12,000 rpm to achieve greater durability of the wheel.
- Round finish available on 5 and 10 mm radius.
- Internal diameter: 16.1 mm (M16 thread).
- For exclusive use with PRO-EDGER.

	REF.				RPM	
R.5 FINE GRAIN PRO-EDGER BEVELING WHEEL	16957	2 5/8" 66 mm	0"	1/4" 6 mm	12000 max.	1
R.10 FINE GRAIN PRO-EDGER BEVELING WHEEL	16958	3" 76 mm	M16 mm	7/16" 11 mm		

 SUPERPRO





 PORCELAIN TILE

 GOOD FINISH

FINE GRAIN PRO-EDGER MITRING WHEEL



- Grinding wheel for mitring.
- Diamond grits fixed by means of a vacuum brazing system.
- Recommended use between 9,000 – 12,000 rpm to achieve greater durability of the wheel.
- 45° type tool with 1–2 mm edge.
- Internal diameter: 16.1 mm (M16 thread).
- For exclusive use with PRO-EDGER.

	REF.				RPM	
45X20 FINE GRAIN PRO-EDGER MITRING WHEEL	16946	3 11/16" 94 mm	0"	13/16" 20 mm	12000 max.	1
45X15 FINE GRAIN PRO-EDGER MITRING WHEEL	16985	3 5/16" 84 mm	M16 mm	9/16" 15 mm		

 SUPERPRO





 PORCELAIN TILE

 FAST

TURBO TWIST COARSE GRAIN PRO-EDGER MITRING WHEEL



- Grinding wheel for mitring.
- Diamond grits fixed by means of a vacuum brazing system.
- Recommended use between 9,000 – 12,000 rpm to achieve greater durability of the wheel.
- The TURBO TWIST model can be used for grinding before finishing with a fine grit, as its grooved design can chip the tile profile.
- Internal diameter: 16.1 mm (M16 thread).
- For exclusive use with PRO-EDGER.

	REF.				RPM	
45X15 TURBO TWIST COARSE GRAIN PRO-EDGER MITRING WHEEL	16984	3 5/16" 84 mm	0" M16 mm	9/16" 15 mm	12000 max.	1



POLISHING PADS



SUPERPRO

NATURAL STONE

QUALITY FINISH

DRY POLISHING DIAMOND PADS

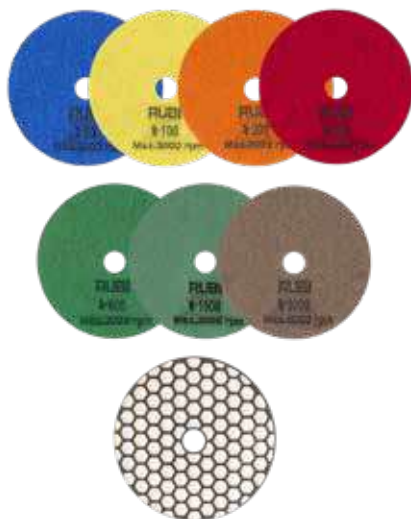

- Range of floppy discs Ø100 mm for polishing, dry, of concrete, marble, granite and other ornamental natural stones.
- It allows removing scratches and surface damage quickly and easily.
- Maximum operating speed: 3,000 rpm.
- Different granulometry.
- # 50, # 100 and # 200 for roughing.
- # 400, # 800, # 1500 and # 3000 polishing and close the pore.
- VELCRO® fastening blade to holder ref. 62986.

	REF.		
DIAMOND PADS DRY POLISHING Ø100 MM - GRAIN # 50	62970	4" 100 mm	1
DIAMOND PADS DRY POLISHING Ø100 MM - GRAIN #100	62971		
DIAMOND PADS DRY POLISHING Ø100 MM - GRAIN #200	62972		
DIAMOND PADS DRY POLISHING Ø100 MM - GRAIN #400	62973		
DIAMOND PADS DRY POLISHING Ø100 MM - GRAIN #800	62974		
DIAMOND PADS DRY POLISHING Ø100 MM - GRAIN #1500	62975		
DIAMOND PADS DRY POLISHING Ø100 MM - GRAIN #3000	62976		

SUPERPRO

NATURAL STONE

QUALITY FINISH

DRY DIAMOND POLISHING PAD BUFF BL.



- Ø100 mm floppy disc for the final buffing, dry, of concrete, marble, granite and other ornamental natural stones.
- Get a natural and long-lasting shine
- Maximum operating speed: 3,000 rpm.
- VELCRO® fastening blade to holder ref. 62986.

	REF.		
DRY DIAMOND POLISHING PAD Ø100 MM BUFF BL.	62977	100	1

SUPERPRO

PAD SUPPORT FOR POLISHING AND BUFFING



- Fixing brackets for flexible polishing and buffing blades Ø100 mm.
- Compatible with jobs dry and water-cooled.
- VELCRO fastening.
- Connection polisher / grinder with M14 thread.

	REF.		
SUPPORT FLOPPY PAD Ø100MM M14	62986	4" 100 mm	1

GRINDING & POLISHING



◆ SUPERPRO

■ PORCELAIN TILE

QUALITY FINISH

LONG LIFE

MANUAL POLISHING PADS

- Range of diamond rubber pads for roughing and edge polishing, cutting and surfaces of natural stone and ceramic tile.
- Semi-flexible. Good adaptation to the user's hand.
- Wet use is recommended.
- Different grain sizes:
 - # 60, # 120 and # 200 for roughing.
 - # 400 for polishing.
- Dimensions of the diamond plate: 55x90 mm.
- Rubber pad dimensions: 58x94x30 mm.



REF.



	REF.	
DIAMOND POLISHING PAD GRAIN # 60	61974	10
DIAMOND POLISHING PAD GRAIN #120	61975	
DIAMOND POLISHING PAD GRAIN #200	61976	
DIAMOND POLISHING PAD GRAIN #400	61977	





MIXING

Electric mixers
Mixing paddles





RUBIMIX E-10 ENERGY CAS

FREEDOM OF MOVEMENT.

For cementitious adhesives, resins, paints and other materials.



Category



PREMIUM



POWER



LIGHT



CAS BATTERY

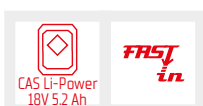

- **Brushless motor. Maintenance-free and increases the product's lifespan. Maximum efficiency.**
- **Powered by a CAS Li-Ion 18V 5.2Ah battery pack, compatible with METABO cordless tools and all of those that form part of the CAS 18V platform.**
- **Light and strong. Maximum reliability.**
- **Dual bi-material grip handle. Better ergonomics, comfort and stability.**
- Equipped with a 2-speed gearbox.
- Progressive switch (RPM control) to optimise the mixing of each material.
- Switch safety lock prevents unintentional start-up.
- LED battery-charge indicator.
- Connection to mixing paddles with M14 thread and FAST-IN adapter (included).
- Double-insulated motor.



	REF.			RPM			
RUBIMIX E-10 ENERGY CAS EU	26570	√	18V	1ª 0-420/ 2ª 0-700	18.9596 Lb 8.6 kg kg	1	20
RUBIMIX E-10 ENERGY CAS UK	26571						
RUBIMIX E-10 ENERGY CAS NO BAT/CHARG.	27913						
BATTERY RUBIMIX E-10 CAS 18V 5.2AH	85902						

ACCESSORIES		Mixer Paddles FAST-IN 3HELIX		RUBIMIX buckets

COMPATIBILITY	
· RUBIMIX E-10 ENERGY CAS	18 V 5.2 Ah
· QUAKE ENERGY CAS	18 V 2.0 Ah
· RUBI TRILLER ENERGY CAS	12 V 4.0 Ah
· OCTO-PLUS ENERGY CAS	12 V 2.0 Ah

RUBIMIX-9 POWER MAX

POWERFUL MULTIPURPOSE ELECTRIC MIXER, SUITABLE FOR CEMENTITIOUS ADHESIVES, RESINS, PAINT, AND OTHER MATERIALS. Facilitates a homogeneous mixing of materials, avoiding the formation of bubbles and/or lumps.



Category



PREMIUM

2100W



POWER







- **High power 2100W.**
- **Electronic speed controller (rpm regulation) to optimize the mixing of each material.**
- **Equipped with 2 speeds gearbox (490/880 rpm).**
- **Mixing paddles connection through exclusive RUBI FAST-IN head for fast paddle change.**
- Greater electrical safety thanks to double isolation.
- Easy and intuitive use.
- Attractive and functional design.
- Ergonomic bi-material handle with improved grip that provides greater. Comfort & stability.
- Chassis in technical plastic, light & resistant.
- Maximum reliability & durability.
- Anti-ignition security system. Prevents inadvertent start-up.
- Soft start system.
- Ø140mm triple helix mixing paddle included (M14 thread continuous full rod) for mortar and cementitious adhesives.
- Direct access to engine brushes for a fast and easy maintenance. Spare brushes and 19 & 22 mm keys included.
- Available version with carrying case (ref.26981).
- Compatible with drill holder and RUBI mixing paddles range.



3+1
YEARS
WARRANTY

1 Prepare **2 3 4 5**

	REF.		W				
RUBIMIX-9 POWER MAX	26980		2100 W	230V/50-60Hz	16.5 Lb 7.5 kg	2	12
RUBIMIX-9 POWER MAX + CASE	26981	✓			25.6 Lb 11.6 kg		

ACCESSORIES

	Mixer Paddles FAST-IN 3HELIX		RUBIMIX buckets
--	------------------------------	--	-----------------





RUBIMIX-9 SUPERTORQUE

VERSATILE ELECTRIC MIXER, SUITABLE FOR CEMENTITIOUS ADHESIVES, RESINS, PAINTS AND OTHER MATERIALS.

Facilitates homogeneous mixing of the materials and prevents the creation of bubbles and/or lumps.



Category

SUPERPRO

1800W

POWER

W
1800 W

PROTECTED DESIGN

CE EAC UK CA

- **Electric mixer with high torque.**
- **Electronic speed controller (rpm control) to OPTIMISE the mixing of each material.**
- **Equipped with a mechanical 2 SPEED gearbox (450/780 rpm).**
- **Better electrical SAFETY thanks to its double insulation.**
- ATTRACTIVE and FUNCTIONAL Design.
- Connection to mixing paddles with M14 thread.
- Double handle with bi-material grip providing better ERGONOMICS, COMFORT and STABILITY.
- Chassis in TECHNICAL, LIGHT, and STRONG plastic. Maximum RELIABILITY AND DURABILITY.
- SAFETY on button. Prevents unintentional start-up.
- Smooth start system.
- Direct access to the motor's brush housing for quick and easy maintenance.
- Includes mixing paddle with 3 helixes of 140 mm diameter for mortars and cementitious adhesives.
- Option to couple a RUBI FAST-IN adapter for paddles (NOT included).
- Includes brushes and 19 and 22 mm spanners.
- Version available with transport case (ref. 26974).
- Compatible with chucks and range of mixing paddles RUBI.



	REF.		W		RPM			
RUBIMIX-9 SUPERTORQUE	26970		1800 W	230V-50/60Hz.	1° 0-450 / 2° 0-780	112 Lb 5.1 kg	2	18
RUBIMIX-9 SUPERTORQUE UK	26971			110V-50/60Hz.				
	26972			220V-50/60Hz.				
RUBIMIX-9 SUPERTORQUE USA + CHUCK	26973			120V-50/60Hz.		19.51 Lb 8.85 kg		
RUBIMIX-9 SUPERTORQUE + CASE	26974	✓		230V-50/60Hz.				
RUBIMIX-9 SUPERTORQUE + CHUCK	26975							

ACCESSORIES		Mortar Mixer M14 Thread 3 ZN-Zinc plated HELIX		Mortar mixer paddle Thread M14 3 HELIX		RUBIMIX buckets



RUBIMIX-16 ERGOMAX

INNOVATIVE AND ERGONOMIC

For cementitious adhesives, resins, paints and other materials.



Category
SUPERPRO

1600W
POWER

REGULABLE

W
1600 W

FAST IN
PATENTED

CE **EAC** **UK CA**

- Handle adjustable in height. Ergonomics adaptable to each user.
- Powerful 1600W motor for greater mixing capacity and high reliability.
- New and improved handle. Comfort and stability.
- Quick Connect System FAST-IN. Change rod without tools.
- Electric mixer mortar powerful 1600 W.
- Double insulation.
- Gearbox with 2 speeds (1st 0-430 rpm / 2nd 0-570 rpm).
- Electronic speed controller (R.P.M. regulation).
- Ø maximum of mixer 160 mm.
- Mixer paddle Ø 140 mm. FAST-IN (5 9/16 ") included.
- Thread Direct link for mixers with M14 finish.
- Weight: 4.6 kg.
- Electrical cable: 3 m.

	REF.		W				
RUBIMIX-16 ERGOMAX 230V 50/60HZ	24994		1600 W	230V 50-60Hz.	10.1 Lb 4.6 kg	2	24
RUBIMIX-16 ERGOMAX 110V 50/60HZ UK	24995	-		110V 50-60Hz.			18
RUBIMIX-16 ERGOMAX 230V 50/60HZ UK	24996			230V 50-60Hz.			24
RUBIMIX-16 ERGOMAX 230V 50/60HZ W/CASE	24998	✓					24

ACCESSORIES

Mixer Paddles FAST-IN 3HELIX

RUBIMIX buckets



RUBIMIX-9 N

VERSATILITY BY CHANGING THE MIXING PADDLE.

For cementitious adhesives, resins, paints and other materials.



Category
SUPERPRO

1200W
POWER

VERSATILITY



- Higher mixing performance, thanks to a more efficient torque.
- 2 speed gearbox and Electronic speed controller (R.P.M. regulation) to optimize the mixing of each material.
- Quick and easy to change the brushes. High comfort.
- Safety lock to prevent unexpected start.
- Power: 1200 W.
- Double insulation.
- Direct connection M14 thread.
- Electronic regulator (1st 0-650 r.p.m. / 2nd 0-850 r.p.m.). Ø maximum paddle: 140 mm.
- Ø 4 3/4" (120 mm) mixing paddle included.

	REF.		W		RPM			
RUBIMIX-9 N	25940		1200 W	210-240V 50-60 Hz	1ª 0-650 / 2ª 0-850	12.1 Lb 5.5 kg	2	24
RUBIMIX-9 N UK	25942			110-130V 50-60 Hz.				
	25944			210-240V 50-60 Hz.				
RUBIMIX-9 N + CHUCK	24986			12.3 Lb 5.6 kg				
RUBIMIX-9 N USA + CHUCK	24949			17.2 Lb 7.8 kg				
RUBIMIX-9 N + CASE	24958	✓	210-240V 50-60 Hz.				18	

ACCESSORIES		Mortar Mixer M14 Thread 3 ZN-Zinc plated HELIX		Plaster mixer paddle Thread M-14		Mortar mixer paddle Thread M14 3 HELIX		RUBIMIX buckets
-------------	--	---	--	----------------------------------	--	--	--	-----------------

MIXING PADDLES FAST-IN



◆ SUPERPRO



ADAPTER FAST-IN THREAD

- Adapter for use of the FAST-IN mixer paddles.
- Transforms threaded connection M14x2 to quick connection system FAST-IN.
- Adaptable to any mixer with M14x2 thread.

REF.

FAST-IN ADAPTER

76907

1

◆ SUPERPRO

■ TILE ADHESIVE

FAST-IN CONNECTION



MIXER PADDLES FAST-IN 3HELIX

- To mix cement mortars.
- Helix head with 3 paddles for better mixing. Increases performance by 15% compared to the 2-blade head.
- Less effort in mixing.
- Less vibrations. Greater comfort.
- Fast connection without tools FAST-IN.
- Compatible with RUBIMIX E-10 ENERGY CAS, RUBIMIX-9 POWER MAX, RUBIMIX-16 ERGOMAX or FAST-IN (Ref. 76907) Adaptable to any mixer with M14x2 connection.

REF.



MIXER PADDLE M-120-FI 3H	76942	33-55 Lb 15-25 kg	24"	4 3/4" 120 mm	2	
MIXER PADDLE M-140-FI 3H	76943	55-88 Lb 25-40 kg	600 mm	5 1/2" 140 mm		84





MIXING PADDLES

• ADAPTABLE TO RUBI MIXERS AND OTHER BRANDS.



▲ PRO
■ TILE ADHESIVE
NON OXIDABLE

MORTAR MIXER M14 THREAD 3 ZN-ZINC PLATED HELIX

- For mixing cement-based mortars.
- Mixing paddle with zinc treatment.
- Paddle head with 3 blades for more efficient mixing. 15% performance improvement compared to heads with two blades.
- Reduces the effort for the electric mixer during the mixing process.
- Generates less vibration. Increased comfort.
- Connection by M14 x 2 thread.
- Can be adapted directly to RUBIMIX range and other brands.

	REF.				
MORTAR MIXER PADDLE M-120-R 3H ZN	76971	33-55 Lb 15-25 kg	24" 600 mm	4 3/4" 120 mm	6
MORTAR MIXER PADDLE M-120-R 3H LONG ZN	76972	55-88 Lb 25-40 kg	29 15/16" 760 mm	5 1/2" 140 mm	2
MORTAR MIXER PADDLE M-140-R 3H ZN	76973	66-132 Lb 30-60 kg	24" 600 mm	5 1/2" 140 mm	2



▲ PRO
■ GYPSUM
NON OXIDABLE

PLASTER MIXER PADDLE THREAD M-14

- For mixing between 33.1 - 66.1 Lb. (15 - 25 kg.) of plaster.
- M14 x 2 thread connection.
- Adaptable directly to RUBIMIX range and other brands.

	REF.				
PLASTER MIXER PADDLE P-120-R	72954	33-66 Lb 15-30 kg	24" 600 mm	4 5/16" 110 mm	2



▲ PRO
■ TILE ADHESIVE
USE WITH DRILLS

MORTAR MIXER 3 HELIX

- To mix cement mortars.
- Helix head with 3 blades for higher efficient mixing.
- Adaptable to RUBIMIX range by chuck (Ref. 71967).

	REF.					
MORTAR MIXER M-80 3H	76945	22-33 Lb 10-15 kg	16" 400 mm	3" 80 mm	6	360
MORTAR MIXER M-100 3H	76946	33-44 Lb 15-20 kg	21 5/8" 550 mm	4" 100 mm	6	



PRO
TILE ADHESIVE
HIGHER PERFORMANCE

MORTAR MIXER PADDLE THREAD M14 3 HELIX

- To mix cement mortars.
- Helix head with 3 paddles for better mixing. Increases performance by 15% compared to the 2-blade head.
- Less effort in mixing.
- Less vibrations. Greater comfort.
- M14 x 2 thread connection.
- Adaptable directly to RUBIMIX range and other brands.

	REF.				
MORTAR MIXER PADDLE M-100-R 3H	76917	33-44 Lb 15-20 kg	21 5/8" 550 mm	4" 100 mm	6
MORTAR MIXER PADDLE M-120-R 3H	76918	33-55 Lb 15-25 kg	24" 600 mm	4 3/4" 120 mm	2
MORTAR MIXER PADDLE M-140-R 3H	76919	55-88 Lb 25-40 kg		5 1/2" 140 mm	
MORTAR MIXER PADDLE M-160-R 3H	76940	66-132 Lb 30-60 kg		6" 160 mm	



PRO
EPOXI RESIN
USE WITH DRILLS

EPOXY MIXER PADDLE E-80

- Special mixing between 2.2 - 4.4 Lb. (1 - 2 kg) of epoxy resins.
- 8 mm hexagonal finish.
- Adaptable to RUBIMIX range by chuck (Ref. 71967).

	REF.				
EPOXY MIXER PADDLE E-80	65939	2-11 Lb 1-5 kg	16" 400 mm	3" 80 mm	6



PRO
LIQUIDS
USE WITH DRILLS

LIQUID MIXER PADDLE - HEXAGONAL ROD

- To mix liquid and low density materials.
- Adaptable to RUBIMIX range by chuck (Ref. 71967).

	REF.					
LIQUID MIXER PADDLE L-80	65933	11-33 Lb 5-15 kg	16" 400 mm	3" 80 mm	6	462
LIQUID MIXER PADDLE L-100	65934	33-55 Lb 15-25 kg	21 5/8" 550 mm	4" 100 mm		



SUPERPRO
TILE ADHESIVE
HIGH MIXING CAPACITY

MORTAR MIXER PADDLE DUPLEX (RUBIMIX-9 DUPLEX)

- To mix up to 66.1 - 110.2 Lb. (30 - 50 kg) of glue mortar. M27 x 1,5 thread finish.
- Fits directly to RUBIMIX-9 DUPLEX.

	REF.					
M-120 DUPLEX PADDLE (2 UN.)	25946	66-110 Lb 30-50 kg	22 7/16" 570 mm	4 3/4" 120 mm	1	72



PRO



RUBIMIX BUCKETS

- Rubber Bucket 65 l. Spare RUBIMIX-50-N and also for use with RUBIMIX-9/9 PLUS and 9 DUPLEX.

	REF.	
BUCKET FOR RUBIMIX-50-N	60202	1

SUPERPRO



CHUCK

- Chuck attachable to the entire RUBIMIX range to work with hexagonal and round finishing rods below 12mm.
- Includes chuck key - S2 Ref. 71969.

	REF.	
CHUCK	71967	1

	UPWARDS MOTION: The material rises through the inner section of the mixing paddle and falls on the outside. This motion allows for an homogeneous mixture of viscous materials such as mortar, cement, glue, etc. Less effort and easier use.	M-120-R 3H ZN M-120-R 3H L ZN M-140-R 3H ZN M-80 3H M-100 3H	M-100-R 3H M-120-R 3H M-140-R 3H M-160-R 3H M-120-FI 3H M-140-FI 3H
	PARALLEL MOTION: The mixture is done horizontally so the materials flow in both directions (up/down) depending on the movement of the paddle. This motion is recommended for resines, bicomponents, liquids, etc. It reduces the amount of bubbles and lumps.	E-80 P-120-R	
	DOWNWARD MOTION: The material is pulled through the paddle's head and rises through the exterior. This motion is recommended for materials with a low viscosity such as paint, sealers, plaster, etc... The lumps are dissolved without splashing.	L-80 L-100	
	COUNTER MOTION: Both paddles work simultaneously generating a more intense mixture. Recommended for resilient and viscous materials such as mortars. Only for dual- paddle mixers.	M-120 DUPLEX	

MIXING PADDLES

	REF		KG	LB	RPM	W	MM	INCH	MM	INCH	MM/INCH					
M-120-R 3H ZN	76971		15-25	33.1-55.1	300-500	950	600	23 5/8"	120	4 3/4"		M14 x 2				
M-120-R 3H L ZN	76972		25-40	55.1-88.2		950	760	29 15/16"								
M-140-R 3H ZN	76973		30-60	66.1-132.3	200-400	1200	600	23 5/8"	140	5 9/16"		M14 x 2				
M-80 3H	76945		10-15	22-33.1	300-500	500	400	15 3/4"	80	3 3/16"			8	5/16"		
M-100 3H	76946		15-20	33.1-44.1		700	550	21 11/16"	100	4"			10	13/32"		
M-100 R 3H	76917				15-25	33.1-55.1	950	600	23 5/8"	120			4 3/4"	140	5 9/16"	
M-120 R 3H	76918		25-40	55.1-88.2												1200
M-140 R 3H	76919				30-60	66.1-132.3	200-400	1500	160	6 5/16"						
M-160 R 3H	76940		15-25	33.1-55.1			300-500	950	600	23 5/8"			120	4 3/4"		FAST-IN
M-120 FI 3H	76942				25-40	55.1-88.2										
M-140 FI 3H	76943		E-80	65939			1-5	2.2-11	300-500	700			400	15 3/4"	80	3 3/16"
					L-80	65933										
		L-100	65934	15-25			33.1-55.1	500	550	21 11/16"			100	4"	10	13/32"
P-120 R	72954		15-30	33.1-66.1	300-500	950	600	23 5/8"	110	4 5/16"			M14 x 2			
M-120 DUPLEX	25946		30-50	66.1-110.2	480	1350	570	22 7/16"	120	4 3/4"	M27 x 1,5					



Quantity to be mixed



Recommended speed (RPM)



Minimum drill power (W)



Total length



Ø of mixer



Rod shape



Material to be mixed



Hexagonal finish



Thread finish



Fast-in



Gypsum



Paint / Liquids



Tile adhesive



Epoxi resin

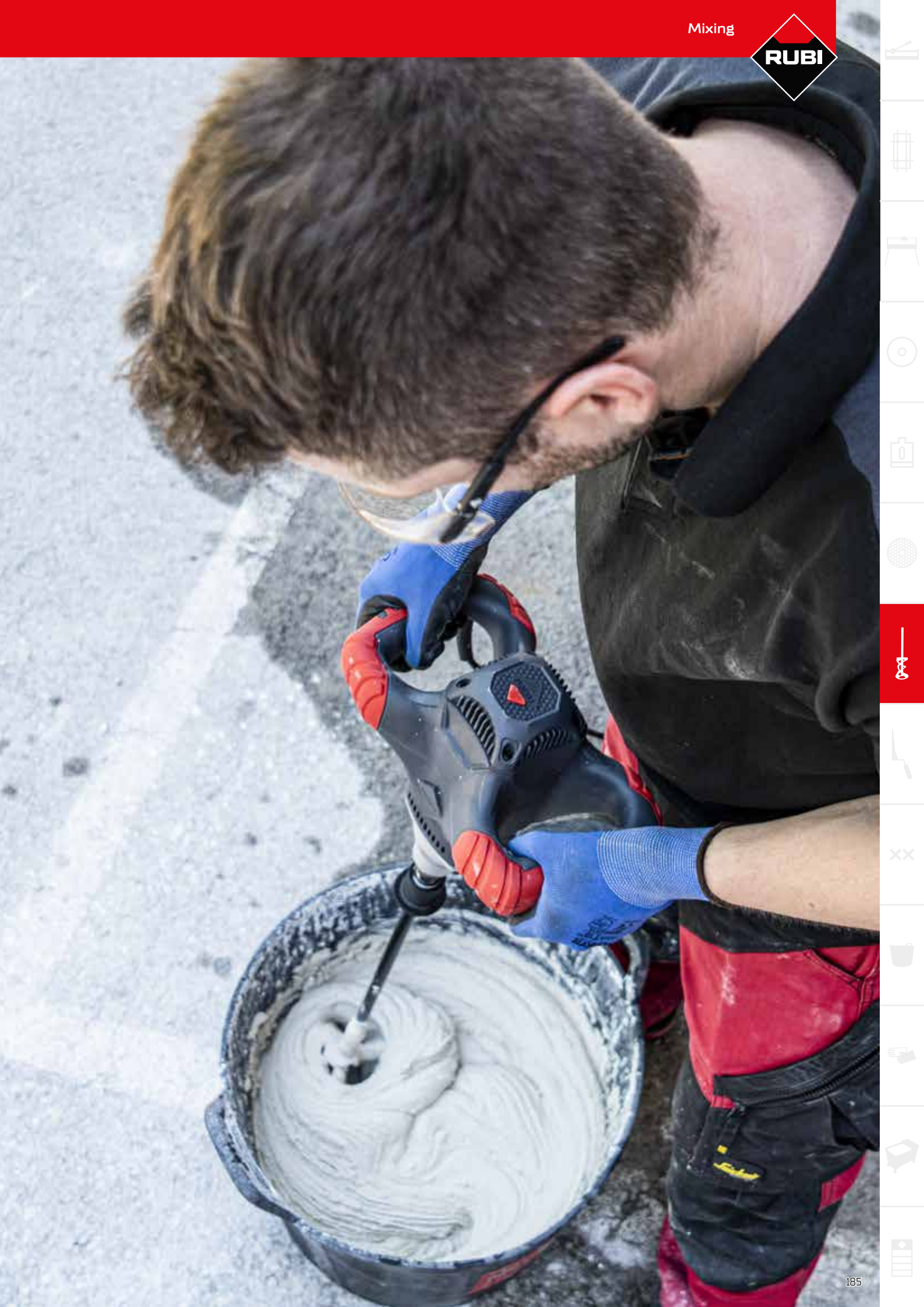



TOOLS

FOR FIXING TILES AND FINISHINGS

Trowels, notched trowels, floats, rubber trowels and spatulas
Markers, chisels, templates and auxiliary tools for tiling
Mallets, Nippers and Grout Mortar Applicators



SELECTION TABLE

	 ADHESIVE MORTAR O PUTTY				
≤ 10 X 10 CM ≤ 4" X 4"			3 X 3 MM 1/8" X 1/8"		
			4,5 X 4,5 MM 3/16" X 3/16"		
			3 X 3 MM 1/8" X 1/8"		
	FROM 10 X 10 TO 20X20 CM FROM 4" X 4" TO 8" X 8"			6 X 6 MM 1/4" X 1/4"	
					6 X 5 MM 1/4" X 7/32"
6 X 6 MM 1/4" X 1/4"					
FROM 20 X 20 TO 30 X 30 CM FROM 8" X 8" TO 12" X 12"			8 X 8 MM 3/8" X 3/8"		
FROM 20 X 20 TO 40 X 40 CM FROM 8" X 8" TO 16" X 16"				R10 R13/32"	
FROM 30 X 30 TO 40 X 40 CM FROM 12" X 12" TO 16" X 16"			6 X 10 MM 1/4" X 13/32"		
* FROM 40 X 40 TO 60 X 60 CM * FROM 16" X 16" TO 24" X 24"			10 X 10 MM 13/32" X 13/32"		
* FROM 60 X 60 TO 80 X 80 CM * FROM 24" X 24" TO 32" X 32"			12 X 12 MM 1/2" X 1/2"		
* >80 X 80 CM" * >32" X 32"			15 X 15 MM 9/16" X 9/16"		
* >60 X 60 CM * > 24" X 24"			20 X 20 MM 13/16" X 13/16"		
* >60 X 60 CM * > 24" X 24"					













Basic conditions:

≥80% Adhesive coverage (dry indoor surfaces).
 Final layer thickness: 5 mm (3/16").
 BACK BUTTERING is not required.

*Back buttering is mandatory when the required coverage is ≥95% (for outdoors or damp areas) or pieces larger than 40 x 40. (16"x16").
 To compensate for the bowing of the tile, add 2x** to the tooth size (** = deformation in the flatness of the tiles).

ADHESIVE MORTAR
 PUTTY

TROWELS AND NOTCHED TROWELS

		WOODEN HANDLE					RUBIFLEX					PLASTIC HANDLE	
													
		●	INOX	●	INOX	●	●	INOX	●	INOX	45°	●	●
	TROWEL	65950	65960	65988	72915		75950	75970		72919		65951	25900
	SHARP		74948										
	3 x 3 mm 1/8 x 1/8"	65989				71923			72906	74936			25901
	4,5 x 4,5 mm 3/16 x 3/16"								74980	74937			25902
	6 x 6 mm 1/4 x 1/4"	65982		65958		71924	75955		72907	74938	75946	65966	25903
	8 x 8 mm 3/8 x 3/8"	65984		65959		71925	75957		72908	74940	75947	65967	25905
	10 x 10 mm 13/32 x 13/32"	65985		65983		71926	75958		72909	74941	75948	65968	25906
	12 x 12 mm 1/2 x 1/2"	74947		73973			75959		74982	74942	75923		25907
	15 x 15 mm 9/16 x 9/16"									76947			
	20 x 20 mm 13/16 x 13/16"			75962									
	R10								72910		75924		
	6 x 5 mm 11/4 x 7/32"								72911				
	YW								77923				



CLOSED HANDLE

CLOSED HANDLE 48cm/
19"

OPEN HANDLE



SPATULA



TROWEL



SHARP EDGES



SQUARE



TRIANGULAR



ROUND



YW

TROWELS AND NOTCHED TROWELS

SUPERPRO

CLOSED HANDLE

WOODEN



TROWELS & NOTCHED TROWELS CLOSED WOOD HANDLE

- Steel plate special high wear resistance with corrosion protection by clear coat. (STEEL).
- Stainless steel plate special high wear resistance (INOX).

	REF.				
STEEL TROWEL 12" [30 CM.]	65950	0" - mm	0" - mm	6	624
INOX TROWEL 12" [30 CM.]	65960				480
SHARP EDGED INOX TROWEL 12" [30 CM.]	74948				-
STEEL NOTCHED TROWEL 11" [28 CM.] 1/8" X 1/8" [3 X 3 MM.]	65989	1/8" 3 mm	1/8" 3 mm	6	624
STEEL NOTCHED TROWEL 11" [28 CM.] 1/4" X 1/4" [6 X 6 MM.]	65982	1/4" 6 mm	1/4" 6 mm		
STEEL NOTCHED TROWEL 11" [28 CM.] 3/8" X 3/8" [8 X 8 MM.]	65984	5/16" 8 mm	5/16" 8 mm		
STEEL NOTCHED TROWEL 11" [28 CM.] 13/32" X 13/32" [10 X 10 MM.]	65985	3/8" 10 mm	3/8" 10 mm		
STEEL NOTCHED TROWEL 11" [28 CM.] 1/2" X 1/2" [12 X 12 MM.]	74947	1/2" 12 mm	1/2" 12 mm		

PRO

WOODEN



SPATULAS & NOTCHED SPATULAS WOOD HANDLE

- 7" (18 cm) wide plate. Special steel high wear resistance.

	REF.				
STEEL NOTCHED SPATULA 7" [18 CM.] 1/8" X 1/8" [3X3 MM.]	71923	1/8" 3 mm	1/8" 3 mm	12	3456
STEEL NOTCHED SPATULA 7" [18 CM.] 1/4" X 1/4" [6X6 MM.]	71924	1/4" 6 mm	1/4" 6 mm		
STEEL NOTCHED SPATULA 7" [18 CM.] 5/16" X 5/16" [8X8 MM.]	71925	5/16" 8 mm	5/16" 8 mm		
STEEL NOTCHED SPATULA 7" [18 CM.] 3/8" X 3/8" [10X10 MM.]	71926	3/8" 10 mm	3/8" 10 mm		



SUPERPRO



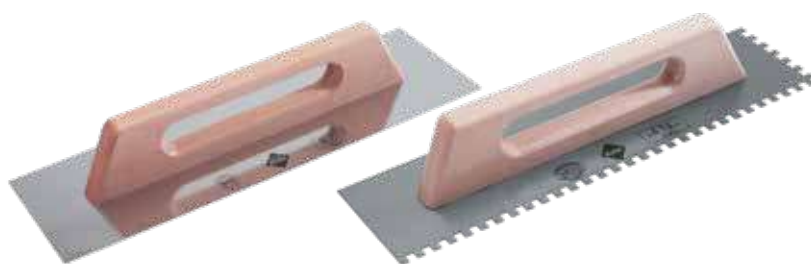

CLOSED HANDLE

WOODEN



19" (48 CM) TROWELS & NOTCHED T. CLOSED WOOD HANDLE

- Steel plate special high wear resistance, corrosion-protected by clear coat (STEEL).
- Stainless steel plate special high wear resistance (INOX)
- Perfect flatness of the plate.
- The notches 13/16" x 13/16" (20 x 20 mm.) developed for dosing of glue mortar on uneven floors. Allows more material thickness.

	REF.				
STEEL TROWEL 19" (48 CM.)	65988	0"	0"	6	360
INOX TROWEL 19" (48 CM.)	72915	- mm	- mm		
STEEL NOTCHED TROWEL 19" (48 CM.) 1/4" X 1/4" (6 X 6 MM.)	65958	1/4" 6 mm	1/4" 6 mm		
STEEL NOTCHED TROWEL 19" (48 CM.) 3/8" X 3/8" (8 X 8 MM.)	65959	5/16" 8 mm	5/16" 8 mm		
STEEL NOTCHED TROWEL 19" (48 CM.) 13/32" X 13/32" (10 X 10 MM.)	65983	3/8" 10 mm	3/8" 10 mm		
STEEL NOTCHED TROWEL 19" (48 CM.) 1/2" X 1/2" (12 X 12 MM.)	73973	1/2" 12 mm	1/2" 12 mm		
STEEL NOTCHED TROWEL 19" (48 CM.) 13/16" X 13/16" (20 X 20 MM.)	75962	13/16" 20 mm	13/16" 20 mm		





SUPERPRO



LEVELLING TROWELS

- Levelling trowels wood handle.
- Special high wear resistant steel plate.
- Plate measures: 15 3/4" x 4 11/32" (40 x 11 cm).

	REF.		
LEVELLING TROWEL POINTED TIP	60997	2	288

▲ SUPERPRO





CLOSED HANDLE

RUBIFLEX



TROWELS & NOTCHED T. CLOSED RUBIFLEX HANDLE

- Steel plate special high wear resistance with corrosion protection by clear coat (STEEL).
- Stainless steel plate high wear resistance (INOX).
- Ergonomic RUBIFLEX handle with two textures.
- Perfect flatness of the plate.

	REF.				
STEEL TROWEL-12" [30 CM.]	75950	0"	0"	6	-
INOX TROWEL 12" [30 CM.]	75970	- mm	- mm		
STEEL NOTCHED TROWEL 11" [28 CM.] 1/4"X1/4" [6X6 MM.]	75955	1/4" 6 mm	1/4" 6 mm		624
STEEL NOTCHED TROWEL 11" [28CM] 3/8"X3/8" [8X8 MM.]	75957	5/16" 8 mm	5/16" 8 mm		
STEEL NOTCHED TROWEL 11" [28CM] 1/2"X1/2" [10X10 MM.]	75958	3/8" 10 mm	3/8" 10 mm		
STEEL NOTCHED TROWEL 11" [28 CM.] 1/2"X1/2" [12X12 MM.]	75959	1/2" 12 mm	1/2" 12 mm		

▲ SUPERPRO





OPEN HANDLE

RUBIFLEX



45° NOTCHED TROWEL RUBIFLEX OPEN HANDLE

- 45° Angled notches for comfort and less user effort.
- Improves adherence of the mortar on to work surface.
- Special carbon steel alloy plate of high wear resistance.
- Extremely light, high resistance aluminium reinforcement.
- Highly rigid joint between the reinforcement and the plate.
- Ergonomic RUBIFLEX handle with two textures.
- Clear coat for protection against corrosion.
- Perfect flatness of the plate.

	REF.					
45° NOTCHED TROWEL 11" [28 CM] 1/4"X1/4" [6X6]	75946	1/4" 6 mm	1/4" 6 mm	0" - mm	6	480
45° NOTCHED TROWEL 11" [28 CM] 3/8"X3/8" [8X8]	75947	5/16" 8 mm	5/16" 8 mm			
45° NOTCHED TROWEL 11" [28 CM] 13/32"X13/32" [10X10]	75948	3/8" 10 mm	3/8" 10 mm			
45° NOTCHED TROWEL 11" [28 CM] 1/2"X1/2" [12X12]	75923	1/2" 12 mm	1/2" 12 mm			
45° NOTCHED TROWEL 11" [28 CM] R-13/32" [10 MM.]	75924	0" - mm	0" - mm			

SUPERPRO





OPEN HANDLE

RUBIFLEX



TROWELS & NOTCHED TROWELS OPEN RUBIFLEX HANDLE

- Extremely light and resistant aluminium core.
- The connection between core and plate is very rigid.
- Highly wear-resistant special steel sheet with protection against corrosion by means of colourless varnish (STEEL).
- Special stainless steel sheet with high wear resistance (SS).
- RUBIFLEX ergonomic handle with two textures.
- Perfect blade flatness.
- YW notched trowel (Ref.77923), with a distinctive and unique shape of notches (not rectangular) to achieve optimal wetting (near 100%) of the tile with the adhesive. Specially created for tiles for which wetting is key (large tiles), and works very well with large format and SLAB type tiles.

	REF.					
INOX TROWEL 11" (28 CM.)	72919	0" - mm	0" - mm			
STEEL NOTCHED TROWEL 1/8"X1/8" (3X3 MM.)	72906	1/8" 3 mm	1/8" 3 mm			
INOX NOTCHED TROWEL 11" (28 CM.) 1/8"X1/8" (3X3 MM.)	74936					
STEEL NOTCHED TROWEL 11" (28 CM.) 3/16"X3/16" (4.5X4.5 MM.)	74980	3/16" 4.5 mm	3/16" 4.5 mm			
INOX NOTCHED TROWEL 11" (28 CM.) 3/16"X3/16" (4.5X4.5 MM.)	74937					
STEEL NOTCHED TROWEL 11" (28 CM.) 1/4"X1/4" (6X6 MM.)	72907	1/4" 6 mm	1/4" 6 mm			270
INOX NOTCHED TROWEL 11" (28 CM.) 1/4"X1/4" (6X6 MM.)	74938					
STEEL NOTCHED TROWEL 11" (28 CM.) 3/8"X3/8" (8X8 MM.)	72908	3/8" 9.5 mm	3/8" 9.5 mm			
INOX NOTCHED TROWEL 11" (28 CM.) 3/8"X3/8" (8X8 MM.)	74940					
STEEL NOTCHED TROWEL 11" (28 CM.) 13/32"X13/32" (10X10 MM.)	72909	13/32" 10 mm	13/32" 10 mm			
INOX NOTCHED TROWEL 11" (28 CM.) 13/32"X13/32" (10X10 MM.)	74941					
STEEL NOTCHED TROWEL 11" (28 CM.) 1/2"X1/2" (12X12 MM.)	74982	1/2" 12 mm	1/2" 12 mm			288
INOX NOTCHED TROWEL 11" (28 CM.) 1/2"X1/2" (12X12 MM.)	74942					270
INOX NOTCHED TROWEL 11" (28 CM.) 9/16"X9/16" (15X15 MM.)	76947	9/16" 15 mm	9/16" 15 mm			-
STEEL NOTCHED TROWEL 11" (28 CM.) R-13/32" (10 MM.)	72910	0" - mm	0" - mm	3/8" 10 mm		
STEEL NOTCHED TROWEL TRIANGULAR 1/4"X7/32" (6X5 MM.)	72911	1/4" 6 mm	3/16" 5 mm	3/16" 5 mm		270
STEEL NOTCHED TROWEL 28 CM. YW	77923	1/4" / 1/2" 6 / 12 mm	5/16" / 1/4" 8 / 7 mm	0" - mm		-

PRO





CLOSED HANDLE

PLASTIC



TROWELS & NOTCHED TROWELS CLOSED PLASTIC HANDLE

• Steel plate special high wear resistance with corrosion protection by clear coat.

	REF.				
STEEL TROWEL 12" [30 CM.]	65951	0" - mm	0" - mm	6	624
NOTCHED TROWEL 11" [28 CM.] 1/4"X1/4" [6X6 MM.]	65966	1/4" 6 mm	1/4" 6 mm		480
NOTCHED TROWEL 11" [28 CM.] 3/8"X3/8" [8X8MM.]	65967	5/16" 8 mm	5/16" 8 mm		
NOTCHED TROWEL 11" [28 CM.] 13/32"X13/32" [10X10 MM.]	65968	3/8" 10 mm	3/8" 10 mm		

PRO



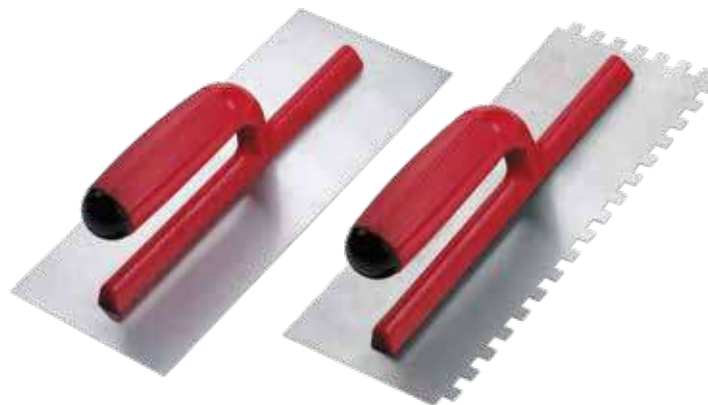

OPEN HANDLE

PLASTIC



TROWELS OPEN PLASTIC HANDLE

- Steel plate. Special high wear resistance.
- Plate trowel: 11" x 4" (28 x 12 cm).
- Plate notched trowel: 11" x 4" (28 x 12 cm).

	REF.				
STEEL TROWEL 11" [28 CM.] OPEN PLASTIC HANDLE	25900	0" - mm	0" - mm	6	720
STEEL NOTCHED TROWEL 11" [28 CM.] 1/8" X 1/8" [3 X 3 MM.]	25901	1/8" 3 mm	1/8" 3 mm		
STEEL NOTCHED TROWEL 11" [28 CM.] 3/16" X 3/16" [4,5 X 4,5 MM.]	25902	3/16" 4,5 mm	3/16" 4,5 mm		
STEEL NOTCHED TROWEL 11" [28 CM.] 1/4" X 1/4" [6 X 6 MM.]	25903	1/4" 6 mm	1/4" 6 mm		
STEEL NOTCHED TROWEL 11" [28 CM.] 5/16" X 5/16" [8 X 8 MM.]	25905	5/16" 8 mm	5/16" 8 mm		
STEEL NOTCHED TROWEL 11" [28 CM.] 3/8" X 3/8" [10 X 10 MM.]	25906	3/8" 10 mm	3/8" 10 mm		
STEEL NOTCHED TROWEL 11" [28 CM.] 1/2" X 1/2" [12 X 12 MM.]	25907	1/2" 12 mm	1/2" 12 mm		

RUBI TROWELS & BRICK TROWEL RANGE

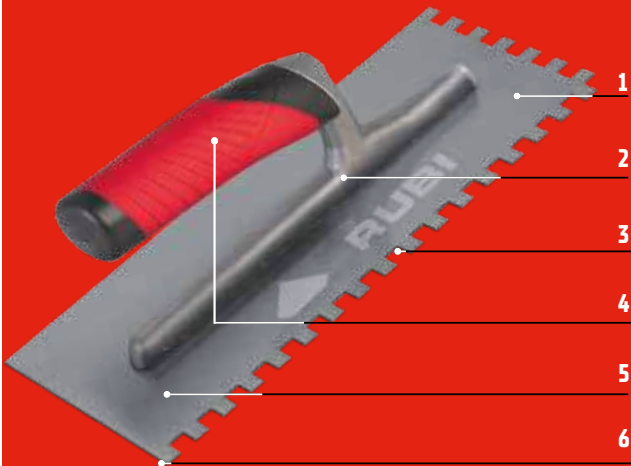

Extremely light and resistance aluminium reinforcement.

Highly rigid fixation between the reinforcement and the plate.

Steel/stainless steel plate with high resistance to abrasion.

Ergonomic RUBIFLEX handle with two textures.

Corrosion protection with clear varnish.

Perfect flatness of the plate.

- 1 Special white nylon lap for tapping without staining.
- 2 Wooden handle in varnished beech.
- 3 Nickel-plated notched ring to increase handle fixation.
- 4 Solid, non-detachable mounting between handle and pin.
- 5 Fusion technique to forging temperature. Fully guaranteed for life against breakage.
- 6 Perfect flatness of the entire plate.
- 7 Plate protected against corrosion.
- 8 Fibres oriented lengthwise during plating.
 - Specific thermal treatment on:
 - Plate, to improve flexibility and prevent wear-off
 - Pin, to improve hardness and rigidity.
- 9 Maximum lightness retaining its resistance.
- 10 Total regularity of all fabrications.
- 11 Perfect adaptation of shapes, sizes and specific characteristics of each market demands.

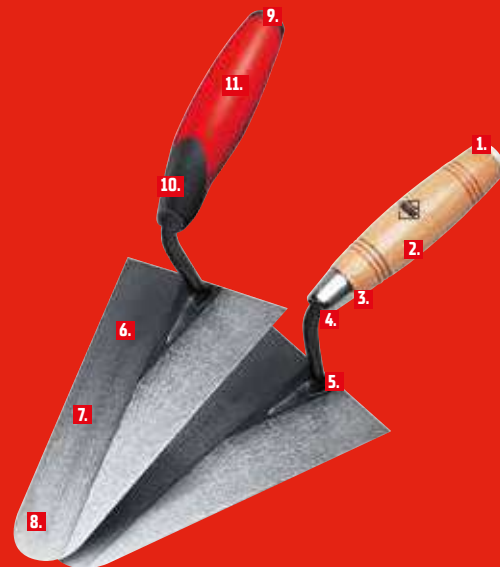

PALETTE LENGTH BY COLOUR

	S	M	L	XL
	50-99 mm 1 15/16" - 3 7/8"	100-129 mm 3 15/16" - 5 1/16"	130-169 mm 5 1/8" - 6 5/8"	170-200 mm 6 1/16" - 7 7/8"

BRICK TROWELS

• PERFECT ADAPTION IN SHAPES, SIZES AND SPECIFIC CHARACTERISTICS MEETING THE DEMANDS OF EACH MARKET.



SUPERPRO



PFP01

• Ergonomic RUBIFLEX.

	REF.				
PFP01-120 MM. [4 3/4"]	75012	4 3/4" 120 mm	2 7/8" 73 mm	0.331 Lb 0.150 kg	6
PFP01-140 MM. [5 1/2"]	75014	5 1/2" 140 mm	2 15/16" 75 mm	0.348 Lb 0.158 kg	

SUPERPRO



PFP05

• Ergonomic RUBIFLEX.

	REF.				
PFP05-180 MM. [7 1/16"]	75418	7" 180 mm	4 1/8" 105 mm	0.628 Lb 0.285 kg	6
PFP05-200 MM. [7 7/8"]	75420	8" 200 mm	4 5/16" 110 mm	0.703 Lb 0.319 kg	

SUPERPRO



PFM06

• Varnished beechwood handle.

	REF.				
PFM06-180 MM. [7 1/16"]	35518	7" 180 mm	5 1/8" 130 mm	0.745 Lb 0.338 kg	6
PFM06-200 MM. [7 7/8"]	35520	8" 200 mm	5 3/8" 137 mm	0.794 Lb 0.360 kg	

SUPERPRO



PFP10

• Ergonomic RUBIFLEX.

	REF.				
PFP10-130 MM. [5 1/8"]	75913	5 1/8" 130 mm	2 3/4" 70 mm	0.278 Lb 0.126 kg	6

SUPERPRO









PFP19

• Ergonomic RUBIFLEX.

	REF.				
PFP19- 80 MM. [4 5/16"]	76808	4 5/16" 109 mm	3" 80 mm	0.335 Lb 0.152 kg	6
PFP19- 90 MM. [5 1/16"]	76809	5 1/16" 128 mm	3 9/16" 90 mm	0.37 Lb 0.168 kg	







**PFM22**

- Varnished beechwood handle.

	REF.				
PFM22-165 MM. [6 5/8"] 	37116	6 5/8" 168 mm	4 11/16" 119 mm	0.791 Lb 0.359 kg	6
PFM22-180 MM. [7 1/4"] 	37118	7 1/4" 184 mm	4 7/8" 124 mm	0.816 Lb 0.370 kg	







**PFP22**

- Ergonomic RUBIFLEX handle.

	REF.				
PFP22-165 MM. [6 5/8"] 	77116	6 5/8" 168 mm	4 11/16" 119 mm	0.807 Lb 0.366 kg	6
PFP22-180 MM. [7 1/4"] 	77118	7 1/4" 184 mm	4 7/8" 124 mm	0.981 Lb 0.445 kg	







**PFM23**

- Varnished beechwood handle.

	REF.				
PFM23-180A MM. [7 3/16"] 	37258	7 3/16" 183 mm	4 5/8" 117 mm	0.78 Lb 0.354 kg	6









**PFP23**

- Ergonomic RUBIFLEX handle.

	REF.				
PFP23-180 A MM. [7 3/16"] 	77258	7 3/16" 183 mm	4 5/8" 117 mm	0.796 Lb 0.361 kg	6
PFP23-185 B MM. [7 1/8"] 	77268	7 1/8" 181 mm	5 3/16" 131 mm	0.86 Lb 0.390 kg	

**PFM24**

- Varnished beechwood handle.





	REF.				
PFM24-140 MM. [5 1/2"] 	37314	5 1/2" 140 mm	3 1/4" 82 mm	0.322 Lb 0.146 kg	6
PFM24-160 MM. [6 5/16"] 	37316	6" 160 mm	3 5/8" 92 mm	0.335 Lb 0.152 kg	
PFM24-180 MM. [7 1/16"] 	37318	7" 180 mm	4 1/16" 103 mm	0.564 Lb 0.256 kg	

SUPERPRO



PFP24

• Ergonomic RUBIFLEX handle.





	REF.				
PFP24-140 MM. [5 1/2"]	77314	5 1/2" 140 mm	3 1/4" 82 mm	0.34 Lb 0.154 kg	6
PFP24-160 MM. [6 5/16"]	77316	6" 160 mm	3 5/8" 92 mm	0.337 Lb 0.153 kg	
PFP24-180 MM. [7 1/16"]	77318	7" 180 mm	4 1/16" 103 mm	0.58 Lb 0.263 kg	
PFP24-200 MM. [7 7/8"]	77320	8" 200 mm	4 5/16" 110 mm	0.606 Lb 0.275 kg	

SUPERPRO



PFP25

• Ergonomic RUBIFLEX handle.





	REF.				
PFP25-180 MM. [7 1/16"]	77418	7" 180 mm	4 5/16" 110 mm	0.668 Lb 0.303 kg	6

SUPERPRO



PFM26

• Varnished beechwood handle.





	REF.				
PFM26-200 MM. [7 7/8"]	37520	8" 200 mm	5 3/16" 132 mm	0.816 Lb 0.370 kg	6

SUPERPRO



PFP33

• Ergonomic RUBIFLEX handle.





	REF.				
PFP33-170X50 MM. [6 11/16" X 1 15/16"]	79050	6 11/16" 170 mm	1 15/16" 50 mm	0.34 Lb 0.154 kg	6

SUPERPRO



PFM55

• Special for tile installers, sharp arrow.

	REF.				
PFM55-165 MM. [6 1/2"]	38416	6 1/2" 165 mm	4 1/2" 114 mm	0.617 Lb 0.280 kg	6

FLOATS

• PLASTER FLOATS

1
Prepare

◆ SUPERPRO



RETICULATED POLYETHYLENE FLOATS

- For finish floating mortar plastering.
- Maximum lighthness and resistance to wear off.
- Very low water absorption. Guarantees dimensional stability.



	REF.	
POINT TIP POREX TROWEL 8 7/8" X 5 1/2" (24 X 14 CM.)	83998	10
RECTANGULAR POREX TROWEL 8 7/8" X 5 1/2" (24 X 14 CM.)	83999	

◆ PRO



POREX FLOATS

- For plastering walls.
- Density and hardness permits an even finish.



	REF.		
POINT TIP POREX TROWEL 9 1/2" X 5" (24 X 14 CM.)	83993	10	240
RECTANGULAR POREX TROWEL 9 1/2" X 5" (24 X 14 CM.)	83992		

◆ PRO



ROUGH PLASTIC HANDLE FLOATS

- Reinforced plate of high resistance to abrasion and long durability.
- Perfectly flat base.

	REF.		
POINT TIP FLOAT 10 X 5" (27 X 14 CM.)	71941	10	360
RECTANGULAR FLOAT 10" X 7" (27 X 18 CM.)	71943		240
RECTANGULAR FLOAT 13" X 9" (34 X 23 CM.)	71944		180



RUBBER GROUT FLOATS

4
Grout

- RUBBER FLOATS FOR GROUTING, WITH ERGONOMIC OR WOODEN HANDLES.
- AVAILABLE IN DIFFERENT RUBBER TO OBTAIN THE BEST FINISHING ACCORDING TO THE JOINT WIDTH.

◆ SUPERPRO

GROUT FLOATS SUPERPRO WOOD

- Wood ergonomic handle.
- Available in different hardnesses of rubber for best finish as the joint width.
- Rubber float trowel, with white rubber sheet wear resistant.
- Solid rubber float, with hard rubber abrasion resistant. Thermoflex float, medium hardness.

	REF.		
RUBBER GROUT FLOAT SUPERPRO	65970	6	540
THERMOFLEX RUBBER GROUT FLOAT SUPERPRO	65976		
SOLID RUBBER GROUT FLOAT SUPERPRO	65975		

◆ SUPERPRO

GROUT FLOATS SUPERPRO PLASTIC

- Plastic ergonomic handle.
- Available in different hardnesses of rubber for best finish as the joint width.
- Rubber float trowel, with white rubber sheet wear resistant.
- Solid rubber float, with hard rubber abrasion resistant. Thermoflex float, medium hardness.

	REF.		
RUBBER GROUT FLOAT SUPERPRO	65971	6	540
THERMOFLEX RUBBER GROUT FLOAT SUPERPRO	65973		
SOLID RUBBER GROUT FLOAT SUPERPRO	65972		

◆ PRO

GROUT FLOATS PRO

- Black foam rubber.
- Grout Float PRO 9"x4" 22.5x10cm. (Ref.10607), with white rubber sheet wear resistant.

	REF.		
RUBBER GROUT FLOAT 9"X4"X19/32" (22,5X10X1,5CM)	10607	6	384
GROUT FLOAT PRO 9 1/2"X4 3/4"X13/32" (24X12X1CM)	24968	10	360
GROUT FLOAT PRO 11"X5"X13/32" (28X14X1CM)	24969		

◆ PRO

REPLACEABLE GROUT FLOAT PRO

- Grout Float (Ref.84924)with sheet resistant to abrasion.
- Replaceable with spare (ref. 84925).

	REF.	
REPLACEABLE GROUT FLOAT PRO	84924	6
SPARE GROUT FLOAT PRO	84925	15

FLOATS FOR PLASTER

• TROWELS FOR THE CORRECT APPLICATION AND SMOOTHING OF PLASTER.

1
Prepare

PRO



PLASTER FLOATS

- Flexible polyethylene and nonstick base.

	REF.	
PLASTIC HANDLE FLOAT 12" X 5" (30 X 14 CM.)	71904	6

SUPERPRO



FLEXIBLE PLASTER FLOATS

- For multi finish and skimming plaster jobs (also compatible with microcement).
- Ideal for vertical jobs in heights.
- 1,2 mm thick polypropylene (PP) plate.

	REF.	
FLEXIBLE FINE PLASTIC HANDLE FLOAT	72824	6

SPATULAS

• GREAT VARIETY OF SPATULAS FOR MULTIPLE PURPOSES.

4
Grout

PRO



WALL TILE GROUT SPATULA

- For filling joints.

	REF.	
WALL TILE GROUT SPATULA 7" (18 CM.)	65954	1
WALL TILE GROUT SPATULA 13" (35 CM.)	65935	

SUPERPRO



FLOOR TILE GROUT SPATULA

- Reinforced spatula for professional jobs. Replaceable strip that can be used on both sides.
- Includes grip and aluminium holder.

	REF.	
FLOOR TILE GROUT SPATULA 24" (60 CM.)	70905	1

PRO

GENERAL PURPOSE SPATULA

- Adaptable to WOODEN HANDLE(Ref. 65450) Not included.



REF.



	REF.	
GENERAL PURPOSE SPATULA 17" (44 CM.)	65919	1
GENERAL PURPOSE SPATULA 24" (60 CM.)	70902	

SUPERPRO

ALUMINIUM HANDLE

- Adaptable to floor tile grout spatula 50, 60 and 75 cm.



REF.



	REF.	
ALUMINIUM HANDLE	70904	1

PRO

WOODEN HANDLE

- Holder for general purpose spatula of 44cm Ref.65919 and 60cm Ref.70902.



REF.



	REF.	
WOODEN HANDLE	65450	1

SUPERPRO

STAINLESS STEEL PAINT SPATULA RUBIFLEX HANDLE

- Stainless steel plate with ergonomic RUBIFLEX handle.



REF.



	REF.	
STAINLESS STEEL PAINT SPATULA 1" 5/8 (40 MM.)	73909	10
STAINLESS STEEL PAINT SPATULA 2" 1/2 (63 MM.)	73914	
STAINLESS STEEL PAINT SPATULA 3" (75 MM.)	73911	
STAINLESS STEEL PAINT SPATULA 4" (100 MM.)	73912	
STAINLESS STEEL PAINT SPATULA 6" (150 MM.)	73913	

SCRAPERS

• MORTAR SCRAPERS, SINGLE LAYER, JOINTS AND PLASTER.

1
Prepare

SUPERPRO

FACADE MORTAR SCRAPER 16" X 2 7/8" (50X72MM)

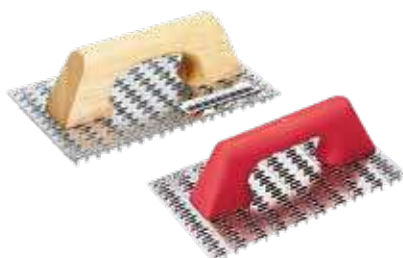

- Facade mortar scraper with wooden handle.
- Plate dimensions: 6x2 7/8" (150x72mm).

	REF.	
WOODEN HANDLE SCRAPER 6X2" 7/8 (150X72 MM.)	65963	6

SUPERPRO

FACADE MORTAR SCRAPER 10" X 5 3/4" (250X144MM)

- Facade mortar scraper with two types of handles: Wood and plastic.
- plate dimensions 10" x 5 3/4" (250x144mm).

	REF.		
WOODEN HANDLE SCRAPER 10" X 5 3/4" (250X144 MM.)	72960	6	480
SPARE SCRAPER 10" X 5 3/4" (250X144 MM.)	65957	18	-
PLASTIC HANDLE SCRAPER 10" X 5 3/4" (250X144 MM.)	65962	6	480

SUPERPRO

ALUMINIUM PLASTER SCRAPER



- Manufactured with aluminium, with 8 blades.
- Dimensions 18" x 3 13/32" (455 x 86 mm).

	REF.		
ALUMINIUM PLASTER SCRAPER	72961	2 Lb 0.9 kg	1

PRO

JOINT SCRAPER

- Ergonomic handle with two electroplated tungsten carbide plates with high resistance to abrasion.
- Useable with 1, 2 or 3 plates depending on width of the joint.
- Supplied in blister.

	REF.		
JOINT SCRAPER	65907	5	600
SPARE JOINT SCRAPER	71974	10	4600

RUBISCRAPER-250

ELECTRIC GROUT SCRAPER

For grout removal without damaging the tile.



Category

SUPERPRO



EASY HANDLING

**IDEAL SMALL
REFORMS**

GOOD FINISH

W
250 W

PATENTED

CE

- **Ergonomic design and bi-material finishing, for greater comfort and better stability.**
- **Light and resistant. Maximum reliability.**
- **Blades made in tungsten carbide. Resharpenable for a greater performance. Patented model.**
- **Fast locking / unlocking system for easy assembly of blade.**
- Ideal for repair work (replacement of broken tiles).
- Equipped with 3 speeds. V1: 6500 i.p. / V2: 8000 i.p. / V3: 9500 i.p.
- Power: 250 W.
- Stroke length: 2 mm.
- Double insulation.
- Blades for joints of 1.5 mm (ref. 66810, use only with speed 1) and 3 mm (ref. 66812) included.
- Includes 2 special blades (steel made) to remove rests of thin-set from the back of the tiles or on the substrate.
- With transport case.
- Interchangeable blades for 1.5, 2, 3 and 4 mm joints.



	REF.	⚡	W	📦
RUBISCRAPER-250	66940	230V-50Hz	250 W	1
RUBISCRAPER-250 UK	66941			
RUBISCRAPER-250 USA	66942	120V-60Hz		

ACCESSORIES



RUBISCRAPER Blades



SUPERPRO



PATENTED

RUBISCRAPER BLADES

- Resharpenable and easily interchangeable blades, available for 1.5mm (use only with speed 1), 2mm, 3mm and 4mm grout sizes.

	REF.	
1.5 MM (1/16") BLADE FOR RUBISCRAPER	66810	1
2 MM (3/32") BLADE FOR RUBISCRAPER	66811	
3 MM (1/8") BLADE FOR RUBISCRAPER	66812	
4 MM (5/32") BLADE FOR RUBISCRAPER	66813	

MARKERS, SUPPORTS AND TEMPLATES

- WIDE RANGE OF MARKERS, SUPPORTS AND TEMPLATES FOR THE PLACEMENT OF TILES.



3
Set

SUPERPRO



RULE SUPPORT SET

- For easy adjustment and levelling of the rule for wall tiling.
- In box of 2 units.

	REF.		
RULE SUPPORT SET 12" (30 CM.)	60991	1	207
RULE SUPPORT SET 20" (50 CM.)	60998		

SUPERPRO



RULE HOLDER NAILS

- Hold firmly the rulers on the walls, allowing a comfortable placement of tiles.

	REF.	
RULE HOLDER NAIL 10" (250 MM.)	72941	6

SUPERPRO



SHAPE TEMPLATE

- Copies the shape of the areas which are awkward to mark onto tiles, for subsequent cutting. Maximum depth 4.5cm.

	REF.	
SHAPE TEMPLATE	70925	10

SUPERPRO



HOLE MARKER

- For marking the position of holes for tubing and electrical fitting, from the wall to the tile, for subsequent cutting or drilling.
- Maximum length 26" (65cm).

REF.



HOLE MARKER XL	72953	6
----------------	-------	---

SUPERPRO



MASTER LINE MARKER

- Ideal system to quickly draw straight lines between two points of the wall or floor.
- Supplied with a bottle of high quality powder for line marker.

REF.



MASTER LINE MARKER	70928	6
--------------------	-------	---

SUPERPRO



"MASTER-N" LINE MARKER

- Ideal system to quickly draw straight lines between two points of the wall or floor.
- Supplied with a bottle of high quality powder for line marker.
- Manufactured in plastic bimaterial (RUBIFLEX)high resistance to impact.
- Includes auxiliary level for leveling rope before tagging.
- Length of rope: 30 m.

REF.



"MASTER-N" LINE MARKER	75925	6
------------------------	-------	---

SUPERPRO



STANDARD LINE MARKER

- Ideal system to quickly draw straight lines between two points of the wall or floor.
- Supplied with a bottle of high quality powder for line marking.
- Length of rope: 15m.

REF.



LINE MARKER W/TRACING POWDER	70926	6
------------------------------	-------	---

SUPERPRO



HIGH QUALITY BLUE POWDER FOR LINE MARKER

- Blue powder for filling the line marker.

REF.



SPARE BLUE POWDER FOR LINE MARKER 2.2 LB. [1 KG.]	70929	6
--	-------	---

SUPERPRO



CONSTRUCTION PENCIL

- Specially designed for writing on wet or glazed surfaces like ceramic tile, marble, granite, etc.
- Set of 2 construction pencils supplied in blister.

	REF.		
CONSTRUCTION PENCIL	65942	50	450

SUPERPRO



LINE REEL

- High resistance polyester cord.

	REF.	
LINE REEL Ø 3/8X164 FT. (1.7 MM. X 50 M)	80933	12

MALLETS

• MALLETS FOR LEVELLING THE HEIGHT OF THE TILES THROUGH OUT INSTALLATION.



SUPERPRO



RUBBER MALLET - 2 FLAT SIDES

- Allows to strike at any angle so as to install the tile into its correct position.

	REF.		
BLACK RUBBER MALLET 8.8 OZ. (250 GR.)	65904	6	336
BLACK RUBBER MALLET 17.6 OZ. (500 GR.)	65905		
BLACK RUBBER MALLET 26.4 OZ. (750 GR.)	65908		252

SUPERPRO



RUBBER MALLET - FLAT/SPHERICAL SIDES

- Allows to strike at any angle. One flat surface and the other spherical.

	REF.		
WHITE RUBBER MALLET 8.8 OZ. (250 GR.)	66905	6	336
WHITE RUBBER MALLET 17.6 OZ. (500 GR.)	66906		
WHITE RUBBER MALLET 26.4 OZ. (750 GR.)	66907		252

SUPERPRO



SOFT BLACK RUBBER MALLET

- A softer mace to protect the ceramic pieces.

	REF.		
SOFT BLACK RUBBER MALLET 17.6 OZ. (500 GR.)	88555	50	600
SOFT BLACK RUBBER MALLET 26.4 OZ. (750 GR.)	88553	40	480

SUCTION CUPS

- SUCTION CUPS TO FACILITATE THE HANDLING OF CERAMICS AND OTHER SMOOTH MATERIALS.

3
Set

 PRO

SINGLE SUCTION CUP

- Maximum load capacity: 88 Lb (40 kg).

REF.



SINGLE SUCTION CUP	65900	1
--------------------	-------	---

 PRO

DOUBLE SUCTION CUP

- Body made of highly resistant aluminium. With ergonomic handle for greater comfort.
- Maximum load capacity : 176.4LB (80 kgs).

REF.



DOUBLE SUCTION CUP	66900	1
--------------------	-------	---

 PRO

TRIPLE SUCTION CUP

- Body made of highly resistant aluminium. With ergonomic handle for greater comfort.
- Maximum load of capacity: 220lbs (100 kg).

REF.



TRIPLE SUCTION CUP	66904	1	80
--------------------	-------	---	----

 SUPERPRO

ROUGH



RM ROUGH SURFACE SUCTION CUP

- Suction cups for handling tiles with rough and/or slightly structured surfaces.
- Injected polycarbonate body. Very light.
- Metal reinforcement in the lever base for greater tensile strength.
- Ergonomic polypropylene handle for faster, safer handling.
- Natural rubber.
- Maximum load capacity: 25 kg.
- Suction cup diameter: 120 mm.

REF.



RM ROUGH SURFACE SUCTION CUPS	66929	1
-------------------------------	-------	---

 SUPERPRO

ROUGH



RM ROUGH SURFACE DOUBLE SUCTION CUP

- Double suction cup for handling tiles with rough and/or slightly structured surfaces.
- Body made of highly resistant aluminium.
- Metal reinforcement in the lever base for greater tensile strength.
- Ergonomic polypropylene handle for faster, safer handling.
- Natural rubber.
- Maximum load capacity: 55 kg.
- Suction cup diameter: 120 mm.

REF.



RM ROUGH SURFACE DOUBLE SUCTION CUP	66952	1
-------------------------------------	-------	---



OCTO-PLUS ENERGY CAS

BATTERY-POWERED SUCTION CUP FOR THE HANDLING OF CERAMIC TILES.
Adapts to any surface finish without leaving a mark on the tile.



NEW!

Category
 PREMIUM

Use
●●●
INTENSIVE

150 kg*
 SECURITY

CAS BATTERY

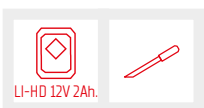

- Bi-material and ergonomic handle.
- Powered by CAS Li-Ion 12V 2Ah battery, compatible with Metabo brand battery tools and with all those that are part of the CAS 12V platform.
- LED battery charge level indicator.
- Maximum load capacity: 150kg.*
- Pressure release mechanism.
- Load loss indicator (LED).
- In the event of a loss of pressure, the vacuum pump is automatically reactivated until the working pressure is reached again.
- *only on smooth surfaces and horizontal loading.

	REF.					
OCTO-PLUS ENERGY CAS EU	66961	12V 2Ah	8" 200 mm	2 Lb 1 kg	33 Lb 15 kg	1
OCTO-PLUS ENERGY CAS UK	66975					
OCTO-PLUS ENERGY CAS USA	66976					
BATTERY CAS LIPOWER 12V 2AH	85903					



NEW!

 **SUPERPRO**
 **PROFESSIONAL**
 **SECURITY** 140 kg*

 **USB BATTERY**

OCTO-USB ENERGY

- Battery suction cup designed for handling ceramic tiles.
- 3.7V battery integrated in the suction cup and charging via USB-C cable.
- In case of loss of pressure, the vacuum pump is automatically reactivated until it reaches working pressure again.
- Maximum load capacity: 140 kg.*
- Includes transport case.
- *only on smooth surfaces and horizontal loading.

	REF.					
OCTO-USB ENERGY	66967	3.7 V 12 Ah	8" 200 mm	2 Lb 1 kg	33 Lb 15 kg	2

 **PREMIUM**
 **VACUUM**
 **SECURITY** 110 kg

SC-200 SUCTION CUP WITH VACUUM PUMP

- Suction cup for handling large and heavy tiles.
- Adapts to any surface finish.
- Suction applied by manual vacuum pump.
- Load loss indicator (red mark).
- Pressure-release mechanism.
- Maximum load capacity: 110kg.

	REF.	
SC-200 SUCTION CUP WITH VACUUM PUMP	18919	1

 **PREMIUM**
 **VACUUM**
 **SECURITY** 110 kg

 **NO MARKS**

GSC-200 GREY VACUUM SUCTION

- Suction cup for the manipulation of large ceramic tiles and heavy porcelain slabs.
- Adapts to any surface without leaving any marks.
- Fixing by vacuum manual pump.
- Load loss indicator (red mark).
- Pressure release mechanism.
- Maximum load capacity: 110 kg.
- High resistance plastic body.

	REF.		
GSC-200 GREY VACUUM SUCTION	21951	3.3 Lb 1.5 kg	1

TILING ACCESSORIES

2
Cut & Drill

SUPERPRO



ABRASIVE BLOCK

- Fine and coarse grit.
- Smooths out tiles.

REF.



ABRASIVE BLOCK	05972	5
----------------	-------	---

SUPERPRO



GLUE GUN APPLICATOR

- Glue applicator 55 W. High performance.
- 100~240V/50~60Hz.
- Compatible with bars of Ø11 - Ø12mm.
- Universal glue.

REF.



GLUE GUN APPLICATOR	65940	6	432
25 GLUE BARS OF 6" [175 MM.]	65946	10	800

WORK TABLES

3
Set

SUPERPRO



FOLDING 4-IN-1 WORKING TABLE

- 4 uses in 1: Work bench, scaffold, dolly and creeper.
- Foldable, easy to transport and storage.
- Double sided board: MDF wood side (work bench function) and non-slippery PP plastic side (rest of functions). EASY interchangeable.
- Reinforced stainless steel area for harder jobs. Avoids damages on wooden surface.
- Angle conveyor and rule printed on the wooden side. Also includes a hole for small drillings (max. 25 mm) and hand tools inserts on metal frame.
- Folded table: 80x52x12,5cm.
- Unfolded table: 115x52x80cm.

REF.



FOLDING 4-IN-1 WORKING TABLE	66924	1	16
------------------------------	-------	---	----

TOOLS BOXES

• TOOL BOXES FOR THE CONSTRUCTION PROFESSIONAL.



SUPERPRO



PROFESSIONAL TOOL BOX

- Large tool box. With wheels and handles for transport.
- Lid with 2 pockets and 4 hangers to fix objects with rubber bands (Not Included).
- It contains internal tray with 4 compartments.
- Outer Dimensions: 31" x 19" x 20" (80 x 49 x 50 cm).
- Inner Dimensions: 24" x 14" x 16" (62 x 35 x 41 cm).
- Capacity: 25 GL (89 L).

	REF.		
PROFESSIONAL TOOL BOX	75965	1	4

SUPERPRO

TRAY COMPARTMENTS



PLASTIC TOOL BOX

- Light and highly functional tool box. With wheels and handle for transport.
- Comes with 2 holders and 4 fitments for attaching objects using elastic bands.
- Consists of 1 tray with 14 compartments that can be configured to specific needs and 1 inside tray with 4 compartments.
- Capacity 15 GL. (55 L).
- Outer Dimensions: 24" x 14" x 16" (61 x 37 x 42 cm).
- Inner Dimensions: 20" x 12" x 14" (51 x 31 x 35 cm).

	REF.		
PLASTIC TOOL BOX	71954	1	8

MALLETS & HAMMERS

- MALLETS AND HAMMERS OF GREAT QUALITY WITH TWO TYPES OF HANDLES, WOOD AND RUBIFLEX.



◆ SUPERPRO



STONING HAMMER WOOD HANDLE

- Special forged Steel head, tempered and hardened.
- SPANISH type head with electrostatic black paint coating and milled hitting ends.
- Varnished, HICKORY wood handle.
- Head's fixation to handle by cylindrical steel wedge and sealed by resin.
- Weight balanced to reduce hand's kickback.

REF.



STONING HAMMER WOOD HANDLE 700 GR.

71896

6

◆ SUPERPRO



STONING HAMMER SOFTGRIP HANDLE

- Special forged Steel head, tempered and hardened.
- SPANISH type head with electrostatic black paint coating and milled hitting ends.
- PP handle with fibre glass core, optimal for shock absorption. Improves handle's long-life.
- Bi-material SOFTGRIP handle, non-slippery and grooved for a better grip.
- Head's fixation to handle by cylindrical steel wedge and sealed by resin.
- Weight balanced to reduce hand's kickback.

REF.



STONING HAMMER SOFTGRIP HANDLE 700 GR.

71898

6

STONING HAMMER SOFTGRIP HANDLE 1000 GR.

71899

◆ SUPERPRO



FRAMER HAMMER RUBIFLEX HANDLE

- Forged, adjusted and tempered steel head of 28.2 oz (800gr). Double placer / remover for nails, one magnetised.
- Ergonomic handle RUBIFLEX: Unbreakable structure with resistant-section fibre-glass nucleus, optimised for shock absorption, increasing the durability of the handle.
 - Security connection between handle and steel head by inverse cone.
 - Grip with elastic slip-proof elastic and surface grooves for maximum hold.

REF.



FRAMER HAMMER 20" (500 MM.)

82986

6

◆ SUPERPRO



MASONRY PICK

- Made of special tempered steel, highly resistant at breaking point.
- Normalised heat treatment and tempered tip.

REF.



MASON PICK (SPADE/PICK) 18 OZ. (500 GR.)

82980

6

CHISELS

• WIDE RANGE OF CHISELS, POINT CHISELS AND NIPPERS.

1
Prepare

SUPERPRO



FLAT CHISELS

- Made of CrVa. alloy steel. Forged, hardened and tempered cutting edge.
- Re grindable.

	REF.	
CHISEL 10" X 29/32" X 17/32" (250 X 23 X 13 MM.)	70916	10
CHISEL 12" X 29/32" X 17/32" (300 X 23 X 13 MM.)	70917	
CHISEL 14" X 29/32" X 17/32" (350 X 23 X 13 MM.)	70918	

SUPERPRO



WIDE CHISELS

- To remove tiles on renovation jobs.
- Made of CrVa. alloy steel. Forged, hardened and tempered cutting edge.
- Re grindable.

	REF.	
WIDE CHISEL 10"/2 3/8" X 1 1/32" X 17/32" (250/60X26X13MM)	70924	10

SHOVELS

• SHOVELS AND SPADES WITH VARNISHED, WOODEN HANDLE AND SPADES HIGHLY RESISTANT AT BREAKING POINT.

1
Prepare

SUPERPRO

"Y" HANDLE

SQUARE SHOVEL



WOODEN RING HANDLED SQUARE SHOVEL

- Squared shovel with wooden handle "Y" shaped.
- Ergonomic grip. Varnished wooden handle.

	REF.		
WOODEN RING HANDLED SQUARE SHOVEL	82960	6	36



SUPERPRO

"T" HANDLE

SQUARE SHOVEL



PROP HANDLED SQUARE SHOVEL

- Squared shovel with wooden handle " T " shaped.
- Varnished wooden handle.

	REF.		
PROP HANDLED SQUARE SHOVEL	82961	6	36



SUPERPRO

"Y" HANDLE

POINTTIPPED SPADE



WOODEN RING HANDLED POINT-TIPPED SPADE

- Shovel with D finish.
- Handle with " Y " ring shaped plastic.
- Ergonomic grip, varnished eucalyptus.

	REF.		
WOODEN RING HANDLED POINT-TIPPED SPADE	82963	6	36



SUPERPRO

"T" HANDLE

POINTTIPPED SPADE



PROP HANDLED POINT-TIPPED SPADE

- Shovel with " D " shape finish.
- Handle T shaped. Varnished wooden handle.

	REF.		
PROP HANDLED POINT-TIPPED SPADE	82964	6	36

NIPPERS

- RANGE OF NIPPERS FOR DIFFERENT USES. FOR PORCELAIN, MOSAICS AND OTHER MATERIALS.





◆ SUPERPRO



CARPENTER'S PINCER

- For general use.
- Supplied in blister.

	REF.		
CARPENTER'S PINCER 8 3/4" (220 MM.)	71971	5	765

◆ SUPERPRO



NIPPERS FOR PORCELAIN TILES

- Specially for cutting narrow strips of a maximum of 7/16" (1cm).
- Replaceable scoring wheels (Ref:01953).
- Equipped with tungsten carbide scoring wheels with titanium surface treatment to last longer. With a gentle turn, the scoring wheels can be repositioned when they start getting worn.



	REF.		
NIPPERS FOR PORCELAIN TILES	83942	5	765

◆ SUPERPRO



PARROT NIPPERS

- Tungsten carbide edge of great hardness.
- To rectify holes on ceramics.

	REF.		
PARROT NIPPERS	65925	5	765

◆ SUPERPRO



NIPPERS FOR CERAMIC TILES

- Tungsten carbide edge of great hardness.
- To rectify cuts of ceramics.

	REF.	
NIPPERS FOR CERAMIC TILES	65926	6

◆ SUPERPRO



NIPPERS FOR GLASS MOSAIC

- Tungsten Carbide edge of great hardness.
- To cut and rectify glass mosaic tiles.

	REF.	
NIPPERS FOR GLASS MOSAIC	71970	5

GROUT MORTAR APPLICATORS

4
Grout

• JOINT APPLICATOR FOR MORTAR.

◆ SUPERPRO



MANUAL GROUT MORTAR APPLICATOR

- Great capacity (650 cc) grout mortar applicator.
- Very light structure made of aluminum.
- It allows an easy, quick and clean application.
- Reduce consumption of grout and after grouting residue.
- Pressure adjustable with trigger.
- Replaceable and adjustable nozzles to the joint width.
- Also usable for the application of silicone and PU rigid and flexible cartridges.
- Quick and clean application.

REF.



MANUAL GROUT MORTAR APPLICATOR 650 CC.	65990	1
--	-------	---

◆ SUPERPRO



SET OF SPARE NOZZLES FOR GROUT MORTAR APPLICATOR

- Spare parts adaptable to Electric (Ref. 66915) and Manual (Ref. 65990) applicators.
- Includes screw, piston and 3 nozzles.

REF.



SET OF SPARE NOZZLES FOR GROUT MORTAR APPLICATOR	65981	9
--	-------	---

◆ SUPERPRO



SPARE NOZZLES

- Spare parts adaptable to Electric (Ref. 66915) and Manual (Ref. 65990) applicators.
- Includes 6 nozzles.

REF.



SPARE NOZZLES FOR GROUT MORTAR APPLICATOR	65980	1
---	-------	---





ACCESSORIES

FOR TILE FIXING AND FINISHING

Measuring systems

Tile spacers

Fast levelling systems



CONSTRUCTION LEVELS

• WIDE RANGE OF LEVELS.



PRO



RUBILEVEL

- Level manufactured in reliable, resistant aluminium.
- Machined base up to measures of 100 cm to ensure constant accuracy.
- Accuracy: 0,5 mm/m three bubbles for checking horizontal, vertical and 45° levels.

	REF.		
RUBILEVEL 16" (40 CM.)	76920	8	2400
RUBILEVEL 24" (60 CM.)	76922		1600
RUBILEVEL 32" (80 CM.)	76923		1120
RUBILEVEL 40" (100 CM.)	76924		
RUBILEVEL 59" (150 CM.)	76926	2	448
RUBILEVEL 79" (200 CM.)	76927		

PRO



RUBILEVEL MAGNET

- Level manufactured with reliable, resistant aluminium.
- Machined base to ensure consistent accuracy and Neodymium magnets inserted to hold it on metal surfaces.
- Accuracy: 0,5 mm/m.
- Three bubbles for checking horizontal, vertical and 45° levels.

	REF.		
RUBILEVEL MAGNET 20" (50 CM.)	76929	8	1920
RUBILEVEL MAGNET 24" (60 CM.)	76930		1600
RUBILEVEL MAGNET 32" (80 CM.)	76931		1120

PRO



RUBILEVEL ANTISHOCK

- Levels manufactured in reliable, resistant aluminum.
- Double machining to ensure a constant precision in the top face and the base.
- Accuracy: 0,5 mm/m.
- Three bubbles for checking horizontal, vertical and 45° levels.
- Double and ergonomic bi-material handle.
- Rubber protector at the ends.
- DUAL view vertical vial for front measurements. Eliminates parallax error.
- MAGNIFIED horizontal vial for the CLEARST view of the bubble.

	REF.		
RUBILEVEL ANTISHOCK 24" (60 CM.)	76932	8	672
RUBILEVEL ANTISHOCK 32" (80 CM.)	76933		504
RUBILEVEL ANTISHOCK 40" (100 CM.)	76934		392
RUBILEVEL ANTISHOCK 48" (120 CM.)	76935		



◆ SUPERPRO

RUBILEVEL ALUCAST

- Level manufactured from cast aluminium.
- Machined base to ensure constant accuracy.
- Accuracy: 0,5 mm/m.
- Two bubbles for checking horizontal and vertical.
- DUAL view vertical vial for front measurements. Eliminates parallax error.



	REF.		
RUBILEVEL ALUCAST 24" (60 CM.)	76938	8	1600
RUBILEVEL ALUCAST 32" (80 CM.)	76939		1120

◆ PRO

WATER LEVEL

- Includes two graduated tanks and 20 metres of hose.
- With caps to maintain the hose correctly filled & ready for the next use.



	REF.	
WATER LEVEL	70965	1

MEASURING TAPES

• HOMOLOGATED PRECISION MEASURING TAPES. TWO MODELS AVAILABLE.



◆ SUPERPRO

RUBIFLEX MEASURING TAPES

- Ergonomic chassis made from plastic and rubber.
- Approved precision measuring tapes: Class II
- Magnetic tape stopper. (only available in mm).



	REF.		
RUBIFLEX MEASURING TAPE 197" X 3/4" (5M X 19MM)	75901	12	864
RUBIFLEX MEASURING TAPE 315" X 1" (8M X 25MM)	75902		576

◆ SUPERPRO

IRONBLADE MEASURING TAPES

- Metal case with rubber coating to improve grip.
- Approved precision measuring tapes: Class II
- Automatic tape lock. (only available in mm).



	REF.	
IRONBLADE MEASURING TAPE 197" X 3/4" (5M X 19MM)	75904	12
IRONBLADE MEASURING TAPE 197" X 3/4" (5M X 25MM.) DOUBLE MARKING	75909	
IRONBLADE MEASURING TAPE 315" X 3/4" (8M X 25MM)	75905	

PLUMB BOB, SQUARES

• PLUMB BOBS.

1
Prepare

◆ SUPERPRO

PLUMB BOB

- Length of line: 16,4 ft. (5 m).
- Includes wooden dolly.
- Supplied in blister.

	REF.		
PLUMB BOB 21.2 OZ. (600 GR.)	70964	6	480

◆ SUPERPRO

SQUARES

- Square 1 5/8" x 13/16" (40x20mm) with high dimensional stability.
- With bichromated treatment.

	REF.	
SQUARE- 24" (60 CM.)	60993	1
SQUARE- 32" (80 CM.)	60994	

TILE SPACERS & WEDGES

• TILE SPACERS, " T " SPACERS AND WEDGES FOR THE CORRECT PLACEMENT OF TILES. QUALITY BASE MATERIAL.

3
Set

◆ SUPERPRO

TILE SPACERS 1/32" (1MM)

- For wall & floor tiles with minimum joint.
- Quality base material, without impurities or imperfections.

	REF.		
TILE SPACERS 1/32" (1 MM.) - (B-300 U.)	02911	10	1200
TILE SPACERS 1/32" (1 MM.) - (B-1000 U.)	02030	1	540

◆ SUPERPRO

TILE SPACER 1/16" (1.5MM)

- For wall & floor tiles with minimum joint.
- Quality base material, without impurities or imperfections.

	REF.		
TILE SPACERS 1/16" (1.5 MM.) - (B-300 U.)	02912	10	960
TILE SPACERS 1/16" (1.5 MM.) - (B-1.000 U.)	02031	1	432



SUPERPRO



TILE SPACER 3/32" (2MM)

- For wall & floor tiles with minimum joint.
- Quality base material, without impurities or imperfections.

	REF.		
TILE SPACERS 3/32" (2 MM.) - (B-300 U.)	02901	10	1680
TILE SPACERS 3/32" (2 MM.) - (B-1.000 U.)	02000	1	768

SUPERPRO



LONG TILE SPACERS 3/32" (2 MM L)

- For large ceramic format and rectified.
- Quality base material, without impurities or imperfections.

	REF.		
LONG TILE SPACERS 3/32" (2 MM.)-L - (B-300 U.)	02952	10	960
LONG TILE SPACERS 3/32" (2 MM.) -L -(B-1000 U.)	02972	1	378

SUPERPRO



TILE SPACERS 1/8" (3MM)

- For floor tiles with thin joint.
- Quality base material, without impurities or imperfections.

	REF.		
TILE SPACERS 1/8" (3 MM.) -(B-200 U.)	02902	10	1200
TILE SPACERS 1/8" (3 MM.) -(B-1.000 U.)	02001	1	324

SUPERPRO



LONG TILE SPACERS 1/8" (3MM L) "REINFORCED"

- For large ceramic format and rectified.
- Quality base material , free from impurities and imperfections.
- Redesigned internal geometry. High flexural strength and crushing.
- Ideal for large format tiles in walls.

	REF.	
LONG TILE SPACERS 1/8" (3 MM.)-L -(B-200 U.)	02953	10
LONG TILE SPACERS 1/8" (3 MM.)-L -(B-1000 U.)	02973	1

SUPERPRO



TILE SPACER 5/32" (4MM) " REINFORCED "

- For floor tiles.
- Quality base material , free from impurities and imperfections.
- Redesigned internal geometry. High flexural strength and crushing.
- Ideal for large formats.



	REF.		
TILE SPACERS 5/32" (4 MM.) -(B-200 U.)	02954	10	960
TILE SPACERS 5/32" (4 MM.) -(B-1000 U.)	02974	1	216

▲ SUPERPRO



TILE SPACERS 3/16" (5MM)

- For floor tiles.
- Quality base material, without impurities or imperfections.
- Hollow structure with internal reinforcements. Supports the tensions and allows to leave into the joint and to grout over.

	REF.		
TILE SPACERS 3/16" (5 MM.) -(B-100 U.)	02903	10	960
TILE SPACERS 3/16" (5 MM.) -(B-1.000 U.)	02002	1	144

▲ SUPERPRO



TILE SPACERS 1/4" (6MM)

- For floor tiles.
- Quality base material, without impurities or imperfections.
- Hollow structure with internal reinforcements. Supports the tensions and allows to leave into the joint and to grout over.

	REF.		
TILE SPACERS 1/4" (6 MM.) - (B-100 U.)	02036	10	540

▲ SUPERPRO



TILE SPACERS 9/32" (7MM)

- For floor tiles.
- Quality base material, without impurities or imperfections.
- Hollow structure with internal reinforcements. Supports the tensions and allows to leave into the joint and to grout over.

	REF.		
TILE SPACERS 9/32" (7 MM.) -(B-100 U.)	02904	10	540

▲ SUPERPRO



TILE SPACERS 13/32" (10MM)

- For industrial or rustic tiles.
- Quality base material, without impurities or imperfections.
- Hollow structure with internal reinforcements. Supports the tensions and allows to leave into the joint and to grout over.

	REF.		
TILE SPACERS 13/32" (10 MM.) -(B-50 U.)	02905	10	540



SUPERPRO



T-SPACERS 3/32" (2MM)

- Ideal for "Brick Bond" and perimeter joints.
- Quality base material without impurities or imperfections.

	REF.		
T-SPACERS 3/32" (2MM) (B-300 UN.)	02861	10	
T-SPACERS 3/32" (2MM) (B-1000 UN.)	02864	1	540

SUPERPRO



T-SPACERS 1/8" (3MM)

- Ideal for "brick style" tiling and perimeters.
- Quality base material, without impurities or imperfections.

	REF.		
T-SPACERS 1/8" (3 MM.) -(B-200 U.)	02923	10	1680
T-SPACERS 1/8" (3 MM.) -(B-1000 U.)	02063	1	540

SUPERPRO



T-SPACERS 3/16" (5MM)

- Ideal for "brick style" tiling and perimeters.
- Quality base material, without impurities or imperfections.
- Hollow structure with internal reinforcements. Supports the tensions and allows to leave into the joint and to grout over.

	REF.		
T-SPACERS 3/16" (5 MM.) -(B-100 U.)	02924	10	2040

SUPERPRO



T-SPACERS 13/32" (10MM.)

- Ideal for "brick style" tiling and perimeters.
- Quality base material, without impurities or imperfections.
- Hollow structure with internal reinforcements. Supports the tensions and allows to leave into the joint and to grout over.

	REF.		
T-SPACERS 13/32" (10 MM.) -(B-50 U.)	02926	10	720





SUPERPRO



WEDGES

- Wedges for tiling.
- Quality base material, without impurities or imperfections.

	REF.		
WEDGES 3/16" (5MM.)- (B-250 U.)	02396	10	2400
WEDGES 3/16" (5 MM.)-(B-500 U.)	02950		1500
WEDGES 5/16" (7.5MM.)- (B-250 U.)	02397		1800
WEDGES 5/16" (7.5 MM.)- (B-500 U.)	02951		960

SUPERPRO



DISPLAY BOX

- Orders by boxes only. Contains bags.

	REF.			
TILE SPACERS 1/32" (1 MM.) - (42 X 300 PC.) DISPLAY BOX	02123	42	300	32
TILE SPACERS 1/16" (1.5 MM.) - (36 X 300 PC.) DISPLAY BOX	02124	36		
TILE SPACERS 3/32" (2 MM.) - (48 X 300 PC.) DISPLAY BOX	02125	48		
TILE SPACERS 1/8" (3 MM.) - (42 X 200 PC.) DISPLAY BOX	02127	42	200	30
TILE SPACERS 3/16" (5 MM.) - (36 X 100 PC.) DISPLAY BOX	02130	36	100	
TILE SPACERS 9/32" (7 MM.) - (16 X 100 PC.) DISPLAY BOX	02132	16		
TILE SPACERS 13/32" (10 MM.) - (18 X 50 PC.) DISPLAY BOX	02135	18	50	32
WEDGES - 3/16" (5 MM.) - (48 X 500 PC.) DISPLAY BOX	02279	48	500	30

SQUARE FORMATS

cm / inch	x m2 / x10 sq.ft.	x m2 / x10 sq.ft.
10 X 10 4" X 4"	140	230
15 X 15 6" X 6"	63	103
20 X 20 8" X 8"	35	58
30 X 30 12" X 12"	16	26
33 X 33 13" X 13"	13	22
40 X 40 16" X 16"	9	15
45 X 45 18" X 18"	7	12
50 X 50 20" X 20"	6	10
60 X 60 24" X 24"	4	7
75 X 75 30" X 30"	3	5
80 X 80 31" X 31"	3	4
90 X 90 35" X 35"	2	3

RECTANGULAR FORMATS

cm / inch	x m2 / x10 sq.ft.	x m2 / x10 sq.ft.
15 X 60 6" X 24"	16	26
15 X 90 6" X 35"	10	18
15 X 120 6" X 47"	8	13
20 X 40 8" X 16"	18	29
20 X 60 8" X 24"	12	20
20 X 80 8" X 31"	9	15
20 X 100 8" X 40"	7	12
25 X 100 10" X 40"	6	10
30 X 60 12" X 24"	8	13
30 X 90 12" X 35"	6	9
30 X 120 12" X 48"	4	7
40 X 80 16" X 31"	5	8

LARGE SPECIAL FORMATS

cm / inch	x pz.	x pz.
100 X 150 40" X 59"	2	4
100 X 300 40" X 118"	2	4
120 X 120 48" X 48"	2	4
120 X 360 48" X 142"	2	4
150 X 150 59" X 59"	2	4
150 X 300 59" X 118"	2	4



CONSUMPTION

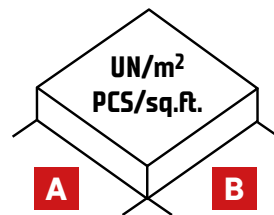

		inch																			
		6	9	12	16	18	20	24	30	32	36	40	48	60	72	80	96	120	128		144
cm	A	8	5,3	6	4,5	4	3,6	3	3,2	3	2,7	2,4	2	2	1,7	1,8	1,5	1,4	1,5	1,3	6
	20	50	3,6	4,0	3,0	2,7	2,4	2,0	2,1	2,0	1,8	1,6	1,3	1,3	1,1	1,2	1,0	0,9	1,0	0,9	9
	25	40	32	4	3	2,7	2,4	2	2	1,9	1,7	1,5	1,3	1,2	1	1,1	0,9	0,8	0,8	0,8	12
	30	50	40	44	2,3	2	1,8	1,5	1,5	1,4	1,3	1,1	0,9	0,9	0,8	0,8	0,7	0,6	0,6	0,6	16
	40	38	30	33	25	1,8	1,6	1,3	1,3	1,3	1,1	1	0,8	0,8	0,7	0,7	0,6	0,5	0,6	0,5	18
	45	33	27	30	22	20	1,4	1,2	1,2	1,1	1	0,9	0,8	0,7	0,6	0,6	0,5	0,5	0,5	0,5	20
	50	30	24	27	20	18	16	1	1	0,9	0,8	0,8	0,6	0,6	0,5	0,5	0,4	0,4	0,4	0,4	24
	60	25	20	22	17	15	13	11	1	0,9	0,8	0,7	0,6	0,6	0,5	0,5	0,4	0,4	0,4	0,3	30
	75	27	21	22	17	15	13	11	11	0,8	0,8	0,7	0,6	0,5	0,4	0,5	0,4	0,3	0,4	0,3	32
	80	25	20	21	16	14	13	10	10	9	0,7	0,6	0,5	0,5	0,4	0,4	0,3	0,3	0,3	0,3	36
	90	22	18	19	14	12	11	9	9	8	7	0,5	0,5	0,4	0,4	0,4	0,3	0,3	0,3	0,3	40
	100	20	16	19	13	11	10	8	8	8	7	6	0,4	0,4	0,3	0,3	0,3	0,2	0,2	0,2	48
	120	17	13	14	10	9	8	7	7	6	6	5	4	0,3	0,3	0,3	0,2	0,2	0,2	0,2	60
	150	17	13	13	10	9	8	7	6	6	5	5	4	4	0,2	0,2	0,2	0,2	0,2	0,2	72
	180	14	11	11	8	7	7	6	5	5	4	4	3	3	2	0,2	0,2	0,2	0,2	0,2	80
	200	15	12	12	9	8	7	6	5	5	4	4	3	3	3	0,2	0,1	0,1	0,1	0,1	96
	240	13	10	10	7	6	6	5	4	4	4	3	3	3	2	2	0,1	0,1	0,1	0,1	120
	300	12	9	9	7	6	5	4	4	4	3	3	3	2	2	2	1	0,1	0,1	0,1	128
	320	13	10	9	7	6	6	5	4	4	3	3	3	2	2	2	1	1	0,1	0,1	144
	360	11	9	8	6	6	5	4	4	3	3	3	2	2	2	1	1	1	1	1	
		20	25	30	40	45	50	60	75	80	90	100	120	150	180	200	240	300	320	360	
		cm																		B	

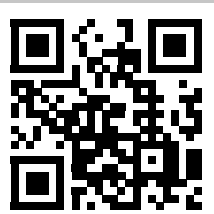

LEVELING SYSTEMS CALCULATOR

*Approximate calculation without considering perimeters or intermediate partitions of the surface to be coated.

TILE LEVEL QUICK: LEVELLING SYSTEM

- SYSTEM TO FACILITATE THE LAYING AVOID LIPPAGE AND IMPROVING FINISHING.

3
Set



- Avoid lippage during the fixing of ceramic tiles in both floor and wall tiles.
- For tile formats from 30x30 cm (12"x12") or bigger. Always with back buttering.
- Guarantee flatness and regularity of the fixing surface.
- Intuitive and easy to use. Results less sensitive to the user's skill.
- Impact removal system. Always in the direction of the grout.
- Compatible with tiles between 3 and 16mm thickness.
- Strip made in technical polymer. System sensitive to humidity.
- Lightweight pliers with bimaterial handle softgrip.
- Quick and comfortable.
- Pliers with 4 work positions. Fast thickness adjust to each tile.





PREMIUM



KIT TILE LEVEL QUICK

• The set consists of pliers, 100 strips and 100 reusable caps. Packaged in a handy bucket.

	REF.		
KIT TILE LEVEL QUICK	02941	1	80

PREMIUM



TILE LEVEL QUICK CAPS

• Reusable caps. Made of POM. Its design ensures even distribution of the contact pressure.

	REF.		
TILE LEVEL CAPS (B-100 U.)	02890	10	300
TILE LEVEL CAPS (B-400 U.)	02892	8	64

PREMIUM



TILE LEVEL QUICK STRIPS

- Made of technical polymer non-hygroscopic.
- Doesn't need soaking before use.
- The strip thickness guarantees minimum grout of 1 mm.
- Ensures continuous tension between strips and capsgroove.
- Grooved bases to improve the wetting of ceramic tile.

	REF.		
TILE LEVEL (B-100 U.) STRIP	02893	6	180
TILE LEVEL (B-400 U.) STRIP	02895		48

PREMIUM



PATENTED

TILE LEVEL QUICK PLIERS

• Ergonomic design with bimaterial handle. Made of very light and resistant materials. Tighten regulation system depending on the thickness of the ceramic tile.

	REF.		
TILE LEVEL QUICK PLIERS	02989	1	756

PREMIUM



TILE LEVEL QUICK HEAVY DUTY PLIERS

- Metal version of the plastic TLQ pliers, fully compatible.
- Made of zinc-plated carbon steel.
- Ergonomic bi-material handle (plastic and rubber).
- Height adjustment with regulation screw (no tools required).

	REF.	
TILE LEVEL QUICK HEAVY DUTY NIPPER	03900	1

DELTA LEVEL SYSTEM: LEVELLING SYSTEM

• SYSTEM TO FACILITATE THE LAYING AVOID LIPPAGE AND IMPROVING FINISHING.

- Avoids lippage during tile laying in both floor and walls.
- For tile formats from 30x30 cm (12"x12") or bigger. Always with back buttering.
- EASY and INTUITIVE use.
- Impact removal system. ALWAYS in the direction of the grout.
- Guarantee flatness and regularity of the laying surface.
- Reusable wedges.
- STURDY pliers with pressure adjustment according to the tile thickness.



KIT DELTA LEVEL SYSTEM

- The kit consists of 1 pliers, 100 strips and 100 reusable wedges.
- Packaged in a handy bucket.

	REF.		
KIT DELTA LEVEL SYSTEM 1MM (3-12MM)	03956	1	80
KIT DELTA LEVEL SYSTEM 1,5MM (3-12MM)	03957		
KIT DELTA LEVEL SYSTEM 2MM (3-12MM)	03958		

◆ SUPERPRO

PATENTED



DELTA LEVEL SYSTEM WEDGE N

- Prevents the generation of lippage during ceramic tile installation, both in flooring and on walls.
- Recommended for formats of 30x30 cm and above, always with back buttering.

	REF.		
DELTA LEVEL SYSTEM WEDGE N (B-100 UN)	03952	12	192
DELTA LEVEL SYSTEM WEDGE N (B-200 UN)	03953	13	104
DELTA LEVEL SYSTEM WEDGE N (B-400 UN)	03954	6	48
DELTA LEVEL SYSTEM WEDGE N (C-1200 UN)	03955	1	16

◆ SUPERPRO

PATENTED



DELTA LEVEL SYSTEM PLIERS FAST-FIX

- FAST-FIX regulation system. Without screws, faster and intuitive.
- Made of steel with bi-material soft-grip handles for greater ergonomics.
- Protective cover on the pressure cam to avoid damaging the tile.

	REF.	
DELTA LEVEL SYSTEM PLIERS FAST-FIX	03901	6

◆ SUPERPRO

NEW!



LEVELLING CERAMIC PROTECTOR

- To protect the tiles against scratching or abrasive damage caused by friction between wedges, caps and delicate tiles, particularly in the presence of sand or hard particles.
- For Delta System wedges or Cyclone system threads.
- Reusable.

	REF.			
LEVELLING CERAMIC PROTECTOR	16902	100	10.8 Lb 4.9 kg	-

◇ SUPERPRO

DELTA LEVEL SYSTEM STRIP

- Made in PP.
- Different models available:
- Strip 0,5 mm / 1 mm / 1,5 mm and 2 mm. for tiles from 3 to 12 mm.
- Strip 1.5 mm and 2 mm for tiles from 11 to 20 mm.
- 3 mm and 5 mm strip for tiles from 6 to 15 mm.
- 5 mm strip for tiles from 13 to 20 mm.



	REF.		
STRIP 3-12MM 0,5MM DELTA LEVEL SYSTEM (B-100 UN)	03929	22	352
STRIP 3-12MM 0,5MM DELTA LEVEL SYSTEM (B-200 UN)	03930	21	168
STRIP 3-12MM 0,5MM DELTA LEVEL SYSTEM (B-400 UN)	03931	13	104
STRIP 3-12MM 0,5MM DELTA LEVEL SYSTEM (B-2400 UN)	03932	1	16
STRIP 3-12MM 1MM DELTA LEVEL SYSTEM (B-100 UN)	02850	22	352
STRIP 3-12MM 1MM DELTA LEVEL SYSTEM (B-200 UN)	02851	21	168
STRIP 3-12MM 1MM DELTA LEVEL SYSTEM (B-400 UN)	02839	13	104
STRIP 3-12MM 1MM DELTA LEVEL SYSTEM (B-2400 UN)	02870	1	16
STRIP 3-12MM 1,5MM DELTA LEVEL SYSTEM (B-100 UN)	02840	22	352
STRIP 3-12MM 1,5MM DELTA LEVEL SYSTEM (B-200 UN)	02841	21	168
STRIP 3-12MM 1,5MM DELTA LEVEL SYSTEM (B-400 UN)	02842	13	104
STRIP 3-12MM 1,5MM DELTA LEVEL SYSTEM (B-2400 UN)	02855	1	16
STRIP 3-12MM 2MM DELTA LEVEL SYSTEM (B-100 UN)	02852	22	352
STRIP 3-12MM 2MM DELTA LEVEL SYSTEM (B-200 UN)	02853	24	192
STRIP 3-12MM 2MM DELTA LEVEL SYSTEM (B-400 UN)	02854	13	104
STRIP 3-12MM 2MM DELTA LEVEL SYSTEM (B-2400 UN)	02856	1	16
STRIP 6-15MM 3MM DELTA LEVEL SYSTEM (B-100 UN)	02866	20	320
STRIP 6-15MM 3MM DELTA LEVEL SYSTEM (B-200 UN)	02867	21	168
STRIP 6-15MM 3MM DELTA LEVEL SYSTEM (B-400 UN)	02868	11	88
STRIP 6-15MM 3MM DELTA LEVEL SYSTEM (B-2400 UN)	02869	1	16
STRIP 6-15MM 5MM DELTA LEVEL SYSTEM (B-100 UN)	06826	20	320
STRIP 6-15MM 5MM DELTA LEVEL SYSTEM (B-200 UN)	06827	21	168
STRIP 6-15MM 5MM DELTA LEVEL SYSTEM (B-400 UN)	06828	11	88
STRIP 6-15MM 5MM DELTA LEVEL SYSTEM (C-2400 UN)	06829	1	16
STRIP 11-20MM 2MM DELTA LEVEL SYSTEM (B-100 UN)	02858	20	320
STRIP 11-20MM 1,5MM DELTA LEVEL SYSTEM (B-100 UN)	02846		
STRIP 13-20MM 5MM DELTA LEVEL SYSTEM (B-100 UN)	06981		



CYCLONE LEVEL SYSTEM: LEVELLING SYSTEM

3
Set

• SYSTEM TO FACILITATE THE LAYING AVOID LIPPAGE AND IMPROVING FINISHING.

- A tool is not required for their installation.
- EASY, QUICK and INTUITIVE to USE. Results less dependent on the skill and experience of the user.
- LARGE and ERGONOMIC Cap. Does not injure fingers when tightening.
- GUARANTEES the flatness and uniformity of the installation surface.
- System removal by IMPACT (kick or mallet). ALWAYS in the direction of the grout joint.
- Reusable caps.
- The base of the clip ensures continuous tension between the clip and the cap.
- The lateral grooves at the base of the clip FACILITATE the spread of the adhesive, thus improving the adhesion of the tile.
- Tightening adjustment system depending on the thickness of the ceramic tile.
- Recommended for tiles with thicknesses from 3 to 20 mm.

◆ SUPERPRO



CYCLONE KIT

- The kit consists of 300 clips and 100 reusable caps.
- Packaged in a practical bucket.

	REF.		
KIT CYCLONE 1,5 MM	35964	1	40
KIT CYCLONE 3 MM	35965		
KIT CYCLONE 5 MM	35903		

◆ SUPERPRO



PATENT
PENDING

CYCLONE CAPS

- Reusable.
- Special 6 mm external thread.
- Eccentric detail for better force concentration.
- Crowned area for better grip.
- Dimensions: 59x59x38 mm
- Supplied in reusable container.

	REF.		
CYCLONE CAPS (B-100)	35949	5	50
CYCLONE CAPS (B-300)	35950	4	24
CYCLONE CAPS (B-1200)	35951	1	12

◆ SUPERPRO



NEW!

LEVELLING CERAMIC PROTECTOR

- To protect the tiles against scratching or abrasive damage caused by friction between wedges, caps and delicate tiles, particularly in the presence of sand or hard particles.
- For Delta System wedges or Cyclone system threads.
- Reusable.

	REF.			
LEVELLING CERAMIC PROTECTOR	16902	100	10.8 Lb 4.9 kg	-



SUPERPRO



CYCLONE FLAT BASE

- Available in various models:
- Flat base clips of 1, 1.5, 2, 3 and 5 mm.
- Visual thickness identification by colour.

	REF.		
CYCLONE L.S. 1 MM FLAT BASE (B-100)	35937	36	12
CYCLONE L.S. 1 MM FLAT BASE (B-300)	35938	12	
CYCLONE L.S. 1 MM FLAT BASE (B-2400)	35939	1	
CYCLONE L.S. 1.5 MM FLAT BASE (B-100)	35940	36	12
CYCLONE L.S. 1.5 MM FLAT BASE (B-300)	35941	12	
CYCLONE L.S. 1.5 MM FLAT BASE (B-2400)	35942	1	
CYCLONE L.S. 2 MM FLAT BASE (B-100)	35943	36	12
CYCLONE L.S. 2 MM FLAT BASE (B-300)	35944	12	
CYCLONE L.S. 2 MM FLAT BASE (C-2400)	35945	1	
CYCLONE L.S. 3 MM FLAT BASE (B-100)	35946	36	12
CYCLONE L.S. 3 MM FLAT BASE (B-300)	35947	12	
CYCLONE L.S. 3 MM FLAT BASE (C-2400)	35948	1	
CYCLONE L.S. 5 MM FLAT BASE (B-100)	35900	36	12
CYCLONE L.S. 5 MM FLAT BASE (B-300)	35901	12	
CYCLONE L.S. 5 MM FLAT BASE (C-2400)	35902	1	

SUPERPRO



CYCLONE CROSS BASE

- Available in various models:
- Cross base clips of 1.5 and 3 mm.
- Visual thickness identification by colour.

	REF.		
CYCLONE L.S. 1.5 MM CROSS BASE (B-100)	35952	36	12
CYCLONE L.S. 1.5 MM CROSS BASE (B-300)	35953	12	
CYCLONE L.S. 3 MM CROSS BASE (B-100)	35955	36	
CYCLONE L.S. 3 MM CROSS BASE (B-300)	35956	12	

SUPERPRO



CYCLONE CROSS T BASE

- Available in various models:
- 1.5 and 3 mm T-base flanges.
- Visual identification of thickness by colours.

	REF.		
CYCLONE L.S. 1.5 MM CROSS T BASE (B-300)	35959	12	12
CYCLONE L.S. 3 MM CROSS T BASE (B-300)	35962		



RUBBLE CHUTES BUCKETS & TUBS

Rubble chutes
Plastic products for construction



REINFORCED PLASTIC RUBBLE CHUTES "LIGHTCHUTE"

• Plastic rubble chutes are a safe and economical way to move rubble and other site waste from high storeys to containers at street level. Their ease of use means that they can be utilized to great effect in any building work over several storeys. Rubble chutes are especially recommended in urban surroundings.



- Ribbed interior protects against wear and tear. Greater durability.
- Dust reduction.
- Fast and easy assembly. Equipped with quick-clip system.
- Stackable; saving space in storage and transit.
- Wide range of accessories.

◆ SUPERPRO



TOP PLASTIC RUBBLE CHUTE "LIGHTCHUTE"

- For loading waste on lightchute chutes.
- Also compatible as top Hopper or an intermediate loading point.
- Excellent resistance to impact by deformation.
- Higher durability.
- 6 mm thick walls with ribbed interior that protects against wear and tear.
- Reduces dust.
- Equipped with 6 mm thick chains, according to DIN 763 norm.
- Locking chain of 3 mm for intermediate chutes.
- Fast and easy assembly. Equipped with quick-clip system.
- Stackable for saving space.



REF.

TOP PLASTIC RUBBLE CHUTE "LIGHTCHUTE"	REF.								
	88765	19 1/8" 485 mm	17 11/16" 450 mm	21 1/4" 54 cm	20" 50 cm	1/4" 6 mm	12.6 Lb 5.7 kg	1	28

◆ SUPERPRO



PLASTIC RUBBLE CHUTE STANDARD SECTION "LIGHTCHUTE"

- Attaches to sections with top and side hoppers and all other chute accessories.



REF.

PLASTIC RUBBLE CHUTE STANDARD SECTION	REF.								
	88760	18 1/2" 470 mm	14 15/16" 380 mm	43 5/16" 110 cm	39" 100 cm	1/4" 6 mm	18.5 Lb 8.4 kg	1	24

ACCESSORIES FOR RUBBLE CHUTES

- WIDE RANGE OF ACCESSORIES FOR RUBBER AND PLASTIC RUBBLE CHUTES.
- THEY PROVIDE A FASTER, SAFER AND MORE COMFORTABLE WAY OF FIXING THE CHUTE TO A BUILDING OR SCAFFOLDING.



PREMIUM



RUBBLE CHUTE SUPPORT BRACKET FOR BUILDINGS

- Mounting bracket for the top of the chute column.
- Reinforced. Holds the weight of the chutes that hang from it.
- Easily attachable to any structural element of the building (floor frame, window, balcony, etc.) thanks to its two fixing positions.
- Includes two clamps for ideal fastening.
- For greater safety and security we recommend installing this piece at intermediate sections of the chute column. Specifically, one piece every 15 metres of chute.

	REF.		
RUBBLE CHUTE SUPPORT BRACKET FOR BUILDINGS	88515	1	5

PREMIUM



CHUTE SCAFFOLD FASTENING SYSTEM

- Mounting bracket to fix top of chute to scaffold.
- Reinforced. Holds the weight of the chutes that hang from it.
- Easily fixes to the scaffold.
- For greater safety and security we recommend installing this piece at intermediate sections of the chute column. Specifically, one piece every 15 metres of chute.

	REF.		
CHUTE SCAFFOLD FASTENING SYSTEM	88517	1	5



PLASTIC BUCKETS "LIGHTBUCK"



- High quality plastic buckets are an outstanding option due to their competitive price and light weight. The range of plastic buckets includes models with capacities of 10, 12, 15 and 22 litres.
- The common characteristics of all the plastic buckets are:
 - Made with high quality polyethylene. Greater robustness.
 - Suitable for all types of work in the construction industry as well as other industries.
 - Very thick walls for maximum strength and resistance.

PRO



ITALIANO PLASTIC BUCKET "LIGHTBUCK" (10 L.)

- Greater comfort during transport. For easy waste collection.
- Highly resistant metal handle.
- Walls are reinforced with ribbing.



	REF.						
"ITALIANO" PLASTIC BUCKET (10 L.)	88770	0" - cm	0" - mm	10 l.	2 Lb 1 kg	10	600

PRO



PLASTIC BUCKET WITH GRADUATION "LIGHTBUCK" (12 L.)

- Greater comfort during transport. For easy waste collection.
- Embossed scale.
- Highly resistant metal handle.
- Walls are reinforced with ribbing.



	REF.						
PLASTIC BUCKET WITH GRADUATION (12 L.)	88776	0" - cm	0" - mm	12 l.	2 Lb 1 kg	10	480

PRO



PLASTIC BUCKET WITH GRADUATION & SPOUT "LIGHTBUCK" (15 L.)

- Greater comfort during transport. For easy waste collection.
- Embossed scale.
- With spout to prevent spillages when pouring.
- With reinforced rim for greater resistance.
- Highly resistant metal handle.
- Walls are reinforced with ribbing.



	REF.						
PLASTIC BUCKET WITH GRADUATION & SPOUT (15 L.)	88775	0" - cm	0" - mm	15 l.	2.6 Lb 12 kg	10	360

PRO

PLASTIC BUCKET MODEL 2 "LIGHTBUCK" HANDLE EXT. (20 L.)

- Greater comfort during transport. Easy waste collection.
- Heavy duty metal handle.
- Plastic handle. Comfort.



	REF.						
PLASTIC BUCKET MODEL 2 "LIGHTBUCK" HANDLE EXT. (20 L.)	88712	14 9/16" 370 mm	10 5/8" 27 cm	20 l.	1.87 Lb 0.85 kg	10	450

PRO

PLASTIC BUCKET MODEL 2 "LIGHTBUCK" (22 L.)

- Greater comfort during transport. Easy waste collection.
- Heavy duty metal handle.
- Plastic handle. Comfort.



	REF.						
PLASTIC BUCKET MODEL 2 WITH PLASTIC HANDLE (22 L.)	88772	14 9/16" 370 mm	10 5/8" 27 cm	22 l.	2 Lb 1 kg	10	450



PLASTIC TUBS "FLEXTUB"

- The high quality plastic tubs are suitable for use in various industries, combine optimal resistance with good flexibility and are very lightweight. Their shape and the design of their handles means that any of the plastic tubs in this range can be carried in one hand with no risk of breakage or fatigue.
- The common characteristics of all the plastic baskets are:
 - Made with high quality polyethylene. Greater robustness.
 - Suitable for all types of work in the construction industry as well as other industries.
 - Very thick walls for maximum strength and resistance.



PRO



PLASTIC BUCKETS "HEAVY DUTY"

- Greater comfort during transport. For easy waste collection.
- Reinforced handles. Greater resistance.
- Lightweight.

PROTECTED DESIGN

REF.



	REF.						
BLACK PLASTIC BUCKET NO.3 (40 L.) HEAVY DUTY	88778	13" 33 cm	17 5/16" 440 mm	40 l.	24 Lb 11 kg	10	300

PRO



PLASTIC TUBS №. 1 "FLEXTUB" (25 L.)

- Greater comfort during transport. For easy waste collection.



REF.



	REF.						
PLASTIC TUB BLACK COLOUR №. 1 (25 L.)	88771	12" 30 cm	14 3/16" 360 mm	25 l.	18 Lb 0.8 kg	10	450

PRO



PLASTIC TUB №. 4 "FLEXTUB" (55 L.)

- Greater comfort during transport. For easy waste collection.
- Lightweight.



REF.



	REF.						
PLASTIC TUB BLACK COLOUR №. 4 (55 L.)	88774	13" 33 cm	20 7/8" 530 mm	55 l.	35 Lb 16 kg	10	200



PRO

PLASTIC TUB Nº. 3 "FLEXTUB" (40 L.)

- Greater comfort during transport. For easy waste collection.
- Reinforced handles. Greater resistance.
- Lightweight.



	REF.						
PLASTIC TUB BLACK COLOUR Nº. 3 (40 L.)	88773						
PLASTIC TUB RED COLOUR Nº. 3 (40 L.)	88726						
PLASTIC TUB YELLOW COLOUR Nº. 3 (40 L.)	88720						
PLASTIC TUB BLUE COLOUR Nº. 3 (40 L.)	88721	13" 33 cm	17 5/16" 440 mm	40 l.	2.9 Lb 1.3 kg	10	300
PLASTIC TUB GREEN COLOUR Nº. 3 (40 L.)	88728						
PLASTIC TUB PISTACHIO COLOUR Nº. 3 (40 L.)	88725						
PLASTIC TUB ORANGE COLOUR Nº. 3 (40 L.)	88724						





SAFETY EQUIPMENT



Personal equipment for construction professionals



KNEE PADS, ERGONOMIC SEAT AND CUSHION

3
Set

• RANGE OF KNEE PADS AND ERGONOMIC SEAT.

PRO

ALL TERRAIN 4X4

KNEE CUSHION

- Polyurethane cushion for protecting the knees.
- Makes it easy to work on the floor without using knee pads.
- Its wide surface allows its use as a seat.



REF.



KNEE CUSHION	65943	1
---------------------	-------	---

PRO

ALL TERRAIN 4X4

FLEX KNEE PADS

- Protection ergonomic flexible. Adjustable elastic band fastener.
- Professional knee pads of high comfort.
- Inner body soft materials suitable to the user.
- Flexible and resistant outer shell.
- Conforms to EN14404.
- Protection level: 1.



REF.



FLEX KNEE PADS	81994	6
-----------------------	-------	---

SUPERPRO

ALL TERRAIN 4X4

PROFESSIONAL KNEE PADS N

- Useful for any task that requires kneeling for prolonged periods of time.
- Ideal for much more comfortable installation of tiles and flooring in general in different phases of the installation: substrate preparation, installation, grouting and cleaning.
- LARGE SUPPORT surface area for optimal STABILITY and COMFORT.
- Double strap for keeping the knee pad tightly fitted to the leg at all times.
- Avoids blocking of blood flow at the back of the knee.
- Quick strap fastening.
- In accordance with EN14404.
- Performance level: 1.



REF.



SET OF PROFESSIONAL KNEE PADS N	66957	6	192
--	-------	---	-----



◇ SUPERPRO HARD SURFACES



GEL COMFORT KNEE PADS

- Ergonomic design professional and high comfort knee pads.
- Its design combines the use of hard materials against impacts and uneven floors and soft materials therein, adapted to the user's anatomy.
- In addition to protecting the user's knees through the use of silicone gel inside, its studied ergonomics provide them with great stability, preventing ligaments and tendons fatigue.
- They incorporate two bands Neoprene closure.
- Conforms to EN14404.
- Protection level: 1.

	REF.		
GEL COMFORT KNEE PADS	81998	6	96

◇ PREMIUM HARD SURFACES



GEL DUPLEX KNEE PADS

- Professional knee pads with ergonomic design. Highly comfortable.
- Their design combines the use of hard materials to protect against impacts and uneven floors and soft materials adaptable to the user's anatomy on the inside.
- Besides protecting the user's knees thanks to the silicone gel in their inside, their studied ergonomics gives them great stability, preventing ligaments and tendons fatigue.
- Wide range of uses thanks to their design " two in one ":
- Can be used together with the external rubber protection of great stability and resistance.
- With the main body only, less bulky, which allows the knee to slide without problem over smooth surfaces.
- They incorporate a double fastener, inferior and superior, easy adjustable.
- Conforms to EN14404.
- Protection level: 1.

	REF.		
GEL DUPLEX KNEE PADS	81989	6	96





◆ SUPERPRO



⚖ HIGH LOAD CAPACITY

🏠 HARD SURFACES



SR-1 ERGONOMIC SEAT

- Aluminum chassis high strength and stability.
- Allows an ergonomic position of comfort.
- Prevents injuries in knees and back.
- Adjustable seat height and angle for optimum adaptation to each use.
- Robust construction with 7 heavy duty wheels.
- Includes tray for tools and accessories.
- Ideal for flooring, parquet installation, cleaning and other operations on pavements tasks.
- Replaceable ergonomic kneepads.
- Maximum weight: 286 lb (130 kg).

	REF.		
SR-1 ERGONOMIC SEAT	81999	1	18





SAFETY EQUIPMENT

• SAFETY EQUIPMENT FOR BUILDING PROFESSIONALS.



◆ SUPERPRO



WHITE LENS GOGGLES

- Field of use: basic.
- Mechanical resistance to high speed particles, low energy.
- Extendable in length and vertically adjustable side pieces.
- Anti-scratch and anti-fog.
- UV Filter.
- Comfortable and light.
- Conforms to EN166 and EN170

	REF.		
WHITE LENS GOGGLES	80918	12	1200

◆ SUPERPRO



EAR PROTECTOR

- Comfortable and effective protection for high noise environments.
- Conforms to EN352-1.

	REF.	
EAR PROTECTOR	80903	6

◆ SUPERPRO



LUMBAR PROTECTOR

- Recommended to avoid low-back injuries when loading weight or maintain fixed positions.
- With vertical reinforcement in the lower-back area.
- Side devices to adjust the pressure at the time of stress.
- Available in 3 sizes: M, L and XL

	REF.	
LUMBAR PROTECTOR - L (37 13/16"-40 15/16") [96-104 CM]	80913	1
LUMBAR PROTECTOR - XL (40 15/16"-44 1/8") [104-112 CM]	80914	

◆ SUPERPRO



LATEX GLOVES

- Ideal for wet or abrasives tasks.
- For minimal risks only.
- Made of 100% latex.
- Conforms to EN420.

	REF.		
LATEX GLOVES	20907	12	3240

◆ SUPERPRO



SET OF SMOOTH SOLES

- Increases contact by 100% approx.

	REF.	
SET OF SMOOTH SOLES	05985	18



**ACCESSORIES FOR
CLEANUP AND
MAINTENANCE**

Products and accessories for cleaning and installing ceramic tile



PRODUCTS FOR CLEANING

- 25 L. AND 200 L. PACKAGES AVAILABLE ON REQUEST, MINIMUM ORDER APPLIES (400 L.)



◆ SUPERPRO



RC-10 CEMENT REMOVER

- Product specially made for cleaning cement, mortar, tile cement and any limestone base substance. Also suitable for spot cleaning of efflorescence (salt) on brick walls, terraces or baked tiles etc...

	REF.	
RC-10 CEMENT REMOVER 5 L. (ONLY AVAILABLE FOR SPAIN, FRANCE, UK, ITALY & CUBA)	22950	2

SPONGES, FLOATS AND PADS

- COMPLETE RANGE OF SPONGES AND GROUT FLOATS FOR CLEANING AND PROTECTION OF TILES.



◆ SUPERPRO



SUPERPRO SPONGES

- PLUS models have cuts for increased drag on the dirt.
- Ref. 20905 and 20906 available in Palbox.

	REF.						
SUPERPRO SPONGE	20905	8x5 1/8x2 3/4" 20x13x7 cm	1	2	24	384	
SUPERPRO SPONGE PLUS	20917					288	
SWEEPEX SUPERPRO SPONGE	20928	7x4x2 3/4" 18x10x7 cm	3	3		384	
SWEEPEX SUPERPRO SPONGE PLUS	20932						
MIXED SUPERPRO SPONGE	20906	8x5 1/8x2 3/4" 20x13x7 cm	4	2	12	288	
MIXED SUPERPRO SPONGE PLUS	20918						
MIXED SWEEPEX SUPERPRO SPONGE SPECIAL FOR JOINTS	20992	7x4x2 3/4" 18x10x7 cm		3			792
EPOXY CELLULOSE SUPERPRO SPONGE	22928	6 11/16x4x1 9/16" 17x10x4 cm		4			
MIXED EPOXY CELLULOSE SUPERPRO SPONGE	22929	6 11/16x4x1 15/16" 17x10x5 cm		4	10	640	



PRO



PRO SPONGES

- Polyurethane sponges.
- HIDRO models are highly absorbent.

	REF.					
STANDARD PRO SPONGE	24966	6 11/16x4x2 3/4" 17x10x7 cm	2	1	24	720
HIGH ABSORPTION HIDRO PRO SPONGE	24967		3	3		

SUPERPRO



SPONGE FLOAT SUPERPRO

- Floats with SUPERPRO sponge for grout cleaning and finishing.
- PLUS model has cuts for increased performance in wiping away dirt.

	REF.					
SPONGE FLOAT SUPERPRO	20924	11 1/16x7 11/16x1" 28x19.5x2.5 cm	1	2	10	180
SPONGE FLOAT SUPERPRO PLUS	20908					

PRO



SPONGE FLOAT PRO

- Polyurethane foam floats with high absorption.
- The PLUS model has slits for increased performance drag dirt.

	REF.					
SPONGE FLOAT PRO	24974	11 1/16x5 1/2x1 3/16" 28x14x3 cm	3	3	10	240
SPONGE FLOAT PRO PLUS	24988					

SUPERPRO



REPLACEABLE SUPERPRO SPONGES 12" X 5 11/32" (30X13,5CM)

- Float sponges for cleaning and finishing tile and grout jobs. Interchangeable sponges adaptable to the ergonomic handle. (Ref. 22912) and secure attachment to other brands.
- Sponges available with different levels of absorption and resistance to abrasion. Comfortable and secure attachment system.
- PLUS models have cuts for increased drag on the dirt.

	REF.					
FLOAT WITH REPLACEABLE SUPERPRO SPONGE	22900	12x5 5/16x1 9/16" 30x13.5x4 cm	1	2	10	180
FLOAT WITH REPLACEABLE SWEEPEX SUPERPRO SPONGE	22916		3	3		
REPLACEABLE SUPERPRO SPONGE	22910		1	2		
REPLACEABLE SUPERPRO SPONGE PLUS	22918					
REPLACEABLE EPOXY CELLULOSE SUPERPRO SPONGE	22932		12x5 5/16x1 3/16" 30x13.5x3 cm	4	4	320
REPLACEABLE SWEEPEX SUPERPRO SPONGE	22922					
REPLACEABLE SWEEPEX SUPERPRO SPONGE PLUS	22914		12x5 5/16x1 9/16" 30x13.5x4 cm	3	3	

◆ SUPERPRO



HANDLE FOR INTERCHANGEABLE SPONGES AND FOAMS

- Adaptable to 12" x 5 11/32" (30 x 13.5 cm.)
- and 13 13/32" x 6 3/4" (34 x 17 cm.) SUPERPRO sponges and foam replacements.

	REF.	
HANDLE FOR INTERCHANGEABLE SPONGES AND FOAMS	22912	10

◆ SUPERPRO



RUBBER FOAM SUPERPRO FLOAT REPLACEMENTS

- Rubber foam sponges basis for finishing and final cleanings, adaptable to ergonomic handle (Ref. 22912)
- Available with different hardness and abrasiveness rubber-foam.



	REF.		
REPLACEMENT RUBBER FOAM BIG CELL SOFT-L SUPERPRO	22924	12x5 5/16x3/8" 30x13.5x1 cm	10

◆ SUPERPRO



RUBBER FOAM PLASTIC HANDLE SUPERPRO FLOATS

- For surface finishing and final cleaning.
- Ergonomic plastic handle.
- Different types of rubber foam and hardness, depending on the type of finish.



	REF.			
RUBBER FOAM BIG CELL SOFT-L SUPERPRO FLOAT	72985	10x4 5/16x9/16" 25x11x1.5 cm	6	540
RUBBER FOAM MEDIUM CELL SOFT-M SUPERPRO FLOAT	72986			
RUBBER FOAM SMALL CELL HARD-S SUPERPRO FLOAT	72988			

◆ PRO



RUBBER FOAM PRO FLOAT

- For finishing and final cleaning of surfaces.

	REF.			
COARSE RUBBER FOAM PRO FLOAT 11 1/32" X 5 1/2" (28 X 14 CM.)	24971	11 1/16x5 1/2x13/16" 28x14x2 cm	10	360
FINE RUBBER FOAM PRO FLOAT 11 1/32" X 5 1/2" (28 X 14 CM.)	24973	11 1/16x4 3/4x13/16" 28x12x2 cm		



◇ SUPERPRO



SUPERPRO SPONGE WITH BASE FOR WASHBOY

- Large area reinforced base.
- Handle included (Ref.70904).
- Polyurethane Sponge.

	REF.					
SWEEPEX SUPERPRO SPONGE WITH BASE FOR WASHBOY	20914	13 3/8x6 11/16x1 15/16"	3	3	1	168
REPLACEMENT SWEEPEX SUPERPRO SPONGE WITH BASE FOR WASHBOY	20919	34x17x5 cm				

◇ SUPERPRO



FLOAT WITH 10" (25 CM.) SUPERPRO PADS

- To clean ceramic surfaces and other materials.
- Float with three different roughness replaceable pads; soft (red), medium (blue) and hard (brown).
- Float with three very stuff pads (white).
- 3 sets of pads: very soft (white), soft (red), medium (blue) and hard (brown).
- Available set of 3 pads of different roughness: soft (red), medium (blue) and hard (brown).

	REF.		
FLOAT + 3 MIXED PADS	20900		
FLOAT + 3 VERY SOFT PADS	20944		
3 PADS REPLACEMENT SET - VERY SOFT	20971	10x4x1" 25x10x2.5 cm	1
3 PADS REPLACEMENT SET - MEDIUM	20973		
3 PADS REPLACEMENT SET - HARD	20974		
3 PADS REPLACEMENT SET - SOFT/MEDIUM/HARD	20902		

STANDARD SWEEPEX | HIDRO CELLULOSA ABRASIVE



Absorption level.

Resistance to abrasion.

SWEEPEX® is a registered trade mark.

WASHBOYS

• **DIFFERENT MODEL OF WASHBOYS FOR CLEANING AWAY GROUT OR FINAL CLEAN OF TILING JOB.**



PRO



RUBICLEAN PRO

- Plastic washboy with two squeeze rollers.
- Wheels built into the base.
- Capacity: 5.3 gl. (24 l.)
- Useful capacity: 3.7 gl. (17 l.)
- Dimensions: 20 1/2" x 10 5/8" x 10 1/4" (52 x 27 x 26 cm).
- Supplied assembled and in 1 unit case.
- Available in Palbox of 12 units (Ref. 69948).

	REF.		
RUBICLEAN PRO WASHBOY	25949	1	18

PRO



RUBICLEAN PRO 1 SET

- Consisting of:
- RUBICLEAN PRO washboy (Ref. 25949).
- Sponge float PRO (Ref. 24974).
- Grout float PRO 11"x5"x13/32" (28x14x1cm) (Ref. 24969).

	REF.		
RUBICLEAN PRO 1 SET	68902	1	18

PRO



RUBICLEAN PRO 2 SET

- Consisting of:
- RUBICLEAN PRO washboy (Ref. 25949).
- Float with replaceable SWEEPEX SUPERPRO sponge (Ref. 22916).
- Rubber grout float SUPERPRO (Ref. 65971).
- 45° Notched trowel 11" (28 cm) 13/32"x13/32" (10x10) (Ref. 75948).

	REF.		
RUBICLEAN PRO 2 SET	69949	1	18



PRO



RUBICLEAN EASYPRO

- Lightweight, strong plastic bucket.
- Lower grate level. Requires less water. More lightweight.
- Removable rollers. Easier cleaning.
- Metal reinforcement on the rollers. Greater resistance.
- Capacity 24 litres.

	REF.		
RUBICLEAN EASYPRO WASHBOY	21945	4	24

SUPERPRO 4 WHEELS 3 ROLLERS



RUBICLEAN TRIPLE SUPERPRO

- Plastic washboy, lightweight and high resistance.
- Equipped with 3 spiral rollers for further draining.
- Includes wheels and carrying handle.
- Capacity: 5.3 gl. (24 l.)
- Useful capacity: 2.2 gl. (10 l.)
- Dimensions: 20 7/8" x 11 1/32" x 14 9/16" (53 x 28 x 37 cm).
- Supplied assembled and in 1 unit box.

	REF.		
RUBICLEAN TRIPLE SUPERPRO WASHBOY	21995	1	18

SUPERPRO



RUBICLEAN SUPERPRO

- Plastic washboy, light and heavy duty, with two squeeze rollers and separation-decantation system of sewage.
- Includes wheels and carrying handle.
- Capacity: 5.3 gl. (24 l.)
- Useful capacity: 4.2 gl. (19 l.)
- Dimensions: 20 1/2" x 10 5/8" x 12" (52 x 27 x 30 cm).
- Supplied assembled and in 1 unit case.
- Available in Palbox of 10 units (Ref. 69964).

	REF.		
RUBICLEAN SUPERPRO WASHBOY	21998	1	18

SUPERPRO



RUBICLEAN SUPERPRO 2 SET

- Consisting of:
- RUBICLEAN SUPERPRO washboy (Ref. 21998).
- Sponge float SUPERPRO (Ref. 20924).
- Termoflex rubber grout float SUPERPRO (Ref. 65976).

	REF.		
RUBICLEAN SUPERPRO 2 SET	69915	1	18



PAL BOX AND DISPLAYS

Index by references

RUBI

*BUILDING THE
FUTURE TOGETHER*

RUBI

*BUILDING THE
FUTURE TOGETHER*

RUBI

*BUILDING THE
FUTURE TOGETHER*

RUBI

*BUILDING THE
FUTURE TOGETHER*



PAL BOX AND DISPLAYS

• **PRODUCT DISPLAY UNITS FOR PLACEMENT OF PRODUCT AT SELLING POINT.**

SUPERPRO



SUPERPRO SPONGE

- Contains x135 units of ref. 20905.
- Dimensions: 23" x 15" x 47" (60 x 40 x 120 cm).

	REF.		
SUPERPRO SPONGE PALBOX	69955	1	4

SUPERPRO



MIXED SUPERPRO SPONGE

- Contains x135 units or ref. 20906.
- Dimensions: 23" x 15" x 47" (60 x 40 x 120 cm).

	REF.	
MIXED SUPERPRO SPONGE PALBOX	69957	1



PRO

HIDRO PRO SPONGE

- Contains x160 units of ref. 24967.
- Dimensions: 23" x 15" x 42" (60 x 40 x 105 cm).





	REF.	
HIDRO PRO SPONGE PALBOX	69979	1

SUPERPRO

KIT DELTA LEVELLING SYSTEM 20 UN.

- Ready to use by just removing the cover.
- It contains:
- 20 DELTA Levelling System kits.
- Measurements: 60 x 40 x 105 cm.



	REF.		
DELTA LEVELLING SYSTEM 1,5MM PAL BOX (20 UN.)	03918	1	2
DELTA LEVELLING SYSTEM 2MM PAL BOX (20 UN.)	03919		





▲ SUPERPRO

RUBICLEAN SUPERPRO WASHBOY

- Contains x10 units of Ref. 21998.
- Washboys are NOT supplied assembled.
- Dimensions: 22" x 12" x 42" (56 x 31 x 109 cm).



REF.



RUBICLEAN SUPERPRO TRAY PALBOX	69964	1
---------------------------------------	-------	---

▲ PRO

RUBICLEAN PRO WASHBOY

- Contains x12 units of Ref. 25949.
- Washboys are NOT supplied assembled.
- Dimensions: 22" x 12" x 42" (56 x 31 x 109 cm).



REF.



RUBICLEAN PRO TRAY PALBOX	69948	1
----------------------------------	-------	---



DISPLAYS

• **VARIOUS DISPLAY UNITS TO SHOW RUBI PRODUCTS, OPTIMIZING SPACE AVAILABLE AND HELPING TO PROMOTE SALES.**



NEW!

1000 MM GENERAL DISPLAY STAND

- 1-metre wide general display stand.
- With a frame, stand and display tray. (Ref. 93911).
- With display bars. (Ref. 93910).
- If you want to set up multiple display stands, calculate the number of bars you will need.

	REF.	
STRUCTURE + HEADER + GENERAL DISPLAY TRAY 1000MM	93911	1
2 UN. GENERAL DISPLAY BARS	93910	



NEW!

650 MM GENERAL DISPLAY STAND

- 65-centimetre wide general display stand.
- With a frame, stand and display tray. (Ref. 90812).
- With 2 display bar units. (Ref. 90810).
- If you want to set up multiple display stands, calculate the number of bars you will need.

	REF.	
STRUCTURE + HEADER + GENERAL DISPLAY TRAY 650MM	93912	1
2 UN. GENERAL DISPLAY BARS	93910	

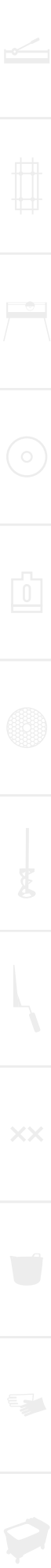



GENERAL DISPLAY TRAY ACCESSORY

• Tray accessory for general display stand.

	REF.	
TRAY GENERAL DISPLAY 40" (1000 MM.)	90570	1
TRAY GENERAL DISPLAY 25" (650 MM.)	90571	



GENERAL DISPLAY CAGE ACCESSORY

• Grid accessory for general display stand.

	REF.	
CAGE GENERAL DISPLAY 40" (1000 MM.)	90606	1
CAGE GENERAL DISPLAY 25" (650 MM.)	90607	



ADJUSTABLE SEPARATOR ACCESSORY

• Spacer accessory for the general display stand

	REF.	
ADAPTABLE DIVIDER 400X200MM	93913	1



MAGNETIC SUPPORT ACCESSORY FOR TROWELS AND NOTCHED TROWELS

• Support accessory with magnetic base for facilitating adjustment on the structure.
• Support for Trowels and Notched Trowels.

	REF.	
MAGNETIC SUPPORT FOR TROWELS 650MM	93915	1
MAGNETIC SUPPORT FOR TROWELS 1000MM	93914	



SUPPORT FOR TROWELS AND NOTCHED TROWELS ACCESSORY

• Support for Trowels and Notched Trowels Accessory for placement in general display.

	REF.	
HOOK BRICK TROWEL 400 MM	93916	1



DISC SUPPORT ACCESSORY

- Disc support accessory.
- It is necessary to use the disc support bar accessory for its correct assembly (Ref.93323/93318).

	REF.	
DISC SUPPORT	93917	1



REINFORCEMENT BAR ACCESSORY FOR DISC SUPPORT

- Disc support bar accessory.
- It is necessary to complement with the disc support accessory (Ref.93917).

	REF.	
REINFORCEMENT BAR 650 MM	93323	1
REINFORCEMENT BAR 1000 MM	93918	



SUPPORT ACCESSORY FOR MALLETs AND HAMMERS

- Support accessory for mallets and hammers, for their placing in the general display stand.

	REF.	
MALLETS & HAMMERS SUPPORT	93919	1



SUPPORT ACCESSORY FOR SIDE SIGN

- Support Accessory for hanging signs on general display stand.

	REF.	
SUPPORT ACCESSORY FOR SIDE SIGN 300MM	93920	1



PRICE-HOLDER HOOK ACCESSORY

- Price hook accessory for placement on general display stand.

	REF.	
PRICE-HOLDER HOOK ACCESSORY	93921	1





MANUAL CUTTERS RACK (1 FACE)

- Metal display stand with the capacity to display a manual cutter.
- It incorporates an anti-theft system.

	REF.	
MANUAL CUTTERS RACK (1 FACE)	93138	1

DISPLAY FOR MANUAL TILE CUTTERS

- Capacity to display 3 manual tile cutters.



	REF.		
DISPLAY FOR MANUAL CUTTERS.	90305	1	6



DISPLAY RANGE LEVELING

• Cardboard dispenser display for the levelling range.

	REF.	
DISPLAY RANGE LEVELING	93056	1

NEW!



DELTA LEVELLING DISPLAY STAND

• Dispenser display stand with 3 cardboard containers, for the Delta levelling range.

	REF.	
3 DISPENSERS DELTA LEVELING DISPLAY	93906	1



NEW!

RUBIMIX RANGE COLUMN DISPLAY STAND

- Display stand with several hooks to hold mixers and different paddles.

	REF.	
MIXERS RANGE COLUMN DISPLAY	93922	1



PREMIUM DRILL BITS DESKTOP DISPLAY

- Table-top metal dispenser for drill bits. It incorporates an anti-theft system.

	REF.	
PREMIUM DRILL BITS DESKTOP DISPLAY	93800	1



DISPLAY FOR 4DRILL BITS

- Desktop dispenser display with six hooks for hanging 4DRILL bits of different diameters.
- With front bar and key locking for anti-theft security.

	REF.	
DISPLAY FOR 4DRILL BITS	91907	1



DISPLAY FOR RUBI DIAMOND BLADES

- Desktop Display for blade saws up to 5" (120mm).
- With front bar and key locking for anti-theft security.
- capacity: 36 blades 4 1/2", 5" (115mm,125mm).

	REF.	
DISPLAY FOR DIAMOND BLADES	92854	1

INDEX BY REFERENCE

REF	PAG	REF	PAG	REF	PAG	REF	PAG	REF	PAG	REF	PAG	REF	PAG	REF	PAG	REF	PAG		
01900	59	02855	233	03955	232	05927	152	06978	151	16901	123	20907	249	24985	54	26992	41	31935	133
01901	59	02856	233	03956	232	05928	152	06979	151	16902	232	20908	253	24986	179	26999	41	31936	140
01903	58	02858	233	03957	232	05929	152	06980	151	16908	73	20914	255	24988	253	27900	39	31937	140
01906	60	02861	227	03958	232	05939	152	06981	233	16909	81	20917	252	24994	178	27901	39	31938	140
01907	61	02864	227	04904	155	05961	154	06984	153	16946	124	20918	252	24995	178	27902	39	31939	140
01945	60	02866	233	04909	155	05962	154	06985	153	16956	123	20919	255	24996	178	27903	39	31964	137
01946	60	02867	233	04910	149	05963	154	06986	153	16957	124	20924	253	24998	178	27909	39	31965	137
01947	61	02868	233	04911	149	05964	154	06987	153	16958	124	20928	252	25900	194	27911	72	31966	140
01948	61	02869	233	04912	149	05965	154	10607	200	16984	124	20932	252	25901	194	27913	173	31967	140
01949	60	02870	233	04913	149	05966	154	10913	88	16985	124	20944	255	25902	194	27916	39	31969	140
01950	61	02890	231	04914	149	05967	154	10971	88	17905	37	20971	255	25903	194	28900	92	31972	135
01958	60	02892	231	04915	149	05969	154	10972	88	17906	37	20973	255	25905	194	28912	83	31973	135
01959	58	02893	231	04916	149	05970	152	11900	33	17909	31	20974	255	25906	194	30883	132	31974	166
01960	63	02895	231	04917	149	05971	152	11901	35	17915	31	20992	252	25907	194	30900	137	31975	135
01991	58	02901	225	04918	153	05972	212	11973	33	17921	31	21931	86	25910	132	30902	137	31978	135
01992	58	02902	225	04920	154	05973	118	11974	35	17924	29	21945	257	25912	139	30904	133	31979	166
01993	58	02903	226	04921	154	05974	118	12954	33	17951	29	21951	91	25913	139	30925	139	32908	137
01996	62	02904	226	04922	154	05976	156	12955	35	17952	29	21955	81	25915	132	30926	139	32921	165
02000	225	02905	226	04923	154	05978	155	12956	33	17953	29	21975	86	25916	132	30929	139	32927	165
02001	225	02911	224	04924	154	05979	155	12957	35	17954	29	21995	257	25917	133	30930	139	32931	165
02002	226	02912	224	04927	155	05981	155	13939	49	18819	81	21998	257	25918	133	30931	139	32932	135
02030	224	02923	227	04928	155	05982	155	13940	49	18910	79	22900	253	25925	117	30945	139	32933	135
02031	224	02924	227	04929	155	05985	249	13941	49	18917	72	22910	253	25927	117	30946	139	32934	142
02036	226	02926	227	04962	148	05988	149	14943	53	18919	91	22912	254	25934	139	30949	139	32935	142
02063	227	02941	231	04963	153	05989	149	14944	53	18920	43	22914	253	25940	179	30950	139	32936	142
02123	228	02950	228	04964	148	05990	149	14945	53	18921	43	22916	253	25942	179	30955	140	32937	165
02124	228	02951	228	04965	148	05991	149	14946	53	18922	43	22918	253	25944	179	30956	140	32938	165
02125	228	02952	225	04970	153	05992	149	14947	53	18923	43	22922	253	25945	117	30958	140	32939	165
02127	228	02953	225	04971	153	05994	149	14948	53	18934	82	22924	254	25946	182	30959	140	32940	132
02130	228	02954	225	04972	153	06826	233	14975	47	18935	85	22928	252	25949	256	30960	140	32951	134
02132	228	02972	225	04973	153	06827	233	14976	47	18948	87	22929	252	25956	55	30962	140	32953	134
02135	228	02973	225	04974	153	06828	233	14977	47	18972	43	22932	253	25963	117	30963	140	32954	134
02279	228	02974	225	04975	153	06829	233	14980	45	18974	43	22950	252	26570	173	30964	140	32960	134
02396	228	02989	231	04976	153	06900	151	14981	45	18975	43	23999	71	26571	173	30972	135	32961	134
02397	228	03900	231	04977	153	06915	151	14982	45	18976	78	24949	179	26961	42	30973	135	32971	139
02839	233	03901	232	04992	148	06918	151	14985	47	18978	87	24956	117	26962	39	30974	132	32974	139
02840	233	03918	261	05917	162	06919	151	14986	47	18979	81	24958	179	26963	41	30976	132	35518	196
02841	233	03919	261	05918	162	06929	151	14987	47	18980	64	24966	253	26970	177	30986	133	35520	196
02842	233	03929	233	05919	162	06971	151	14988	45	18982	77	24967	253	26971	177	30987	133	35900	235
02846	233	03930	233	05920	162	06972	151	14989	45	18983	80	24968	200	26972	177	30995	137	35901	235
02850	233	03931	233	05921	162	06973	151	14990	45	18984	84	24969	200	26973	177	31909	143	35902	235
02851	233	03932	233	05922	162	06974	151	15901	51	20900	255	24971	254	26974	177	31915	132	35903	234
02852	233	03952	232	05923	152	06975	151	15902	51	20902	255	24973	254	26975	177	31932	133	35937	235
02853	233	03953	232	05924	152	06976	151	15904	51	20905	252	24974	253	26980	175	31933	133	35938	235
02854	233	03954	232	05926	152	06977	151	16900	69	20906	252	24984	54	26981	175	31934	133	35939	235

INDEX BY REFERENCE

REF	PAG	REF	PAG	REF	PAG	REF	PAG	REF	PAG	REF	PAG	REF	PAG	REF	PAG
35940	235	50938	150	52940	101	58852	119	65934	182	66940	205	71970	65	75909	223
35941	235	50939	120	52942	101	58853	119	65935	201	66941	205	71971	217	75913	196
35942	235	50944	156	52947	127	58854	119	65939	182	66942	205	71974	203	75923	192
35943	235	50947	156	52948	72	58856	119	65940	212	66952	209	72824	201	75924	192
35944	235	50956	121	52960	103	58863	119	65942	208	66957	246	72906	193	75925	207
35945	235	50957	121	52961	103	58869	119	65943	246	66961	90	72907	193	75946	192
35946	235	50958	121	52962	103	58909	113	65946	212	66967	91	72908	193	75947	192
35947	235	50959	121	52970	103	58913	113	65950	190	66975	90	72909	193	75948	192
35948	235	50962	128	52971	103	58915	113	65951	194	66976	90	72910	193	75950	192
35949	234	50964	129	52972	103	58916	119	65954	201	68902	256	72911	193	75955	192
35950	234	50994	121	53500	126	58917	118	65957	203	68923	150	72915	191	75957	192
35951	234	50996	150	54822	119	60202	183	65958	191	69915	257	72919	193	75958	192
35952	235	50998	129	54844	119	60926	92	65959	191	69948	262	72941	206	75959	192
35953	235	50999	129	54911	109	60934	89	65960	190	69949	256	72953	207	75962	191
35955	235	51908	156	54913	109	60938	89	65962	203	69955	260	72954	181	75965	213
35956	235	51914	118	54914	109	60942	89	65963	203	69957	260	72960	203	75970	192
35959	235	51915	118	54918	72	60953	89	65966	194	69964	262	72961	203	76808	196
35962	235	51916	118	54975	111	60991	206	65967	194	69979	261	72980	92	76809	196
35964	234	51927	118	54976	111	60993	224	65968	194	70902	202	72985	254	76907	180
35965	234	51929	151	54977	111	60994	224	65970	200	70904	202	72986	254	76917	182
37116	197	51931	151	54999	119	60997	191	65971	200	70905	201	72988	254	76918	182
37118	197	51937	151	55903	111	60998	206	65972	200	70916	215	73909	202	76919	182
37258	197	51939	152	55905	111	61974	169	65973	200	70917	215	73911	202	76920	222
37314	197	51941	126	55906	111	61975	169	65975	200	70918	215	73912	202	76922	222
37316	197	51949	75	55907	111	61976	169	65976	200	70924	215	73913	202	76923	222
37318	197	51951	75	55938	111	61977	169	65980	218	70925	206	73914	202	76924	222
37520	198	51967	75	56924	107	62970	168	65981	218	70926	207	73973	191	76926	222
38416	198	51977	75	56937	105	62971	168	65982	190	70928	207	74936	193	76927	222
40910	141	51987	75	56938	105	62972	168	65983	191	70929	207	74937	193	76929	222
40911	141	51989	127	56939	105	62973	168	65984	190	70930	65	74938	193	76930	222
40913	141	51997	127	56940	115	62974	168	65985	190	70964	224	74940	193	76931	222
40914	141	51999	72	56941	105	62975	168	65988	191	70965	223	74941	193	76932	222
40917	138	52905	99	56942	115	62976	168	65989	190	71896	214	74942	193	76933	222
40918	138	52906	99	56943	105	62977	168	65990	218	71898	214	74947	190	76934	222
41900	136	52915	99	56947	105	62986	168	66810	206	71899	214	74948	190	76935	222
41901	136	52916	99	56949	105	65450	202	66811	206	71904	201	74980	193	76938	223
45910	116	52918	99	57903	149	65900	209	66812	206	71923	190	74982	193	76939	223
45911	116	52920	101	57904	149	65904	208	66813	206	71924	190	75012	196	76940	182
45915	116	52927	99	57906	149	65905	208	66900	209	71925	190	75014	196	76942	180
45916	116	52928	99	57907	149	65907	203	66904	209	71926	190	75418	196	76943	180
50903	154	52929	103	57908	149	65908	208	66905	208	71941	199	75420	196	76945	181
50917	150	52930	101	57941	118	65919	202	66906	208	71943	199	75901	223	76946	181
50921	155	52937	103	57991	118	65925	64	66907	208	71944	199	75902	223	76947	193
50936	150	52938	164	58850	119	65926	65	66924	212	71954	213	75904	223	76971	181
50937	155	52939	164	58851	119	65933	182	66929	209	71967	183	75905	223	76972	181

SYMBOLY AND CERTIFICATIONS

In this catalogue to provide reader's with the maximum amount of information and to be as clearly as possible, we have used the following symbols:

	Prepare		Units per pallet		Segment Thickness		Cutting Length		Folding legs
	Cut & Drill		Units per box		Diamond band height		Cutting height		Mobile cart
	Set		Cutting length		Diamond band width		Separator power		Adjustable flow
	Grout		Diagonal cutting length		Maximum drill length		Fixed separator		Tip-up table for mitring
	Clean		Cutting height		Mixing capacity		Mobile separator		Zero Dust
	3+1 years warranty		Separator power		Max Height of the head		Repetitive cuts		Level
	3+2 years warranty		Net weight without packaging		Rod's head diametre		45° cuts		Laser
	3 year warranty		Gross weight		Wide notched trowel		Base accessory		C3 system
	Patented		With carrying case		Notched height trowel		Angular measuring		Wet cutting
	Patent Pending		Weight with carrying case		Notched Radius Trowel		Dual reinforced guide		Dry cutting
	Patent Pending		Power supply		Trowel length		PURE POWER		1 hour of continuous work maximum, recommended by TNO
	European Regulatory Commission	RPM	Revolutions per minute		Trowel width		MAGNET		3 hours of continuous work maximum, recommended by TNO
	Russian legislation EAC	W	Watts		Bags per box		Smart Power		
	Normative UK		Mitre cutting length		N° tile spacers per bag		One Hand Action		
	TÜV safety rules		Mitre Thickness cut		Height of bucket		Back pack optional		
	TNO innovation for life		Maximum cutting thickness - 1 stroke or 2 strokes		Bottom diameter		Bearing system		
	AD1		Length Width Height		Top diameter		Easy fix		
	Product Design Award		Wall chaser effect		Useable height		Ergonomic		
	TUV mark		Cut length with saw effect		Sponge size		Soft		
			With blade		Absorption level (1-4)		INCH/MM. ruler		
			Outside diameter		Resistance to abrasion (1-4)		Power		
			Inside diameter				Foldable head		
			Disc segment high				Plunge Effect		

UK : Ref. 93238

 8 413797 932386

EUROPA : Ref. 93239

 8 413797 932393

HINDU : Ref. 93240

 8 413797 932409

ASIA : Ref. 93241

 8 413797 932416

Rubi Group comply with the Directive 2002/96/ EC on waste electrical and/or electronic and Directive 2002/95/EC on the restriction of certain substances in their manufacture, applying the law of each member state according to EEC your specific criteria. (WEEE, WEEE, ECORAE, etc ...) (RoHS).

Images are for illustration purposes and may change without notice.
 *The gross weight of some electrical machines may vary depending on the type of pallet and carton type used in packaging.
 **Any manipulation or modification of machine voids the warranty. Our warranty covers defects in manufacturing or assembly in accordance with the applicable law.

Note: Any reproduction of all or part of this catalogue without prior approval of Germans Boada, SA is forbidden



RUBI CLUB

JOIN THE COMMUNITY OF 70.000+ EXPERTS IN THE ART OF TILING

1. SIGN UP IN LESS THAN 1 MINUTE
2. EXTEND THE WARRANTY OF YOUR PURCHASES EASILY
3. GAIN ACCESS TO EXCLUSIVE BENEFITS AND GIFTS

SCAN THE QR CODE OR ENTER WWW.RUBI.COM



After Sales Service
aftersales@rubi.com

f y d i
rubi.com

RUBI GROUP

SP **GERMANS BOADA, S.A.**
BARCELONA (OFICINAS CENTRALES)
Pol. Can Rosés,
Avda. Olimpiades 89-91, P.O.BOX 14
08191 RUBI (Barcelona) SPAIN
T. 34 936 80 65 00
info@rubi.com

MADRID
Marie Curie,7
Edif. B. bajos 7
28521 Rivas Vaciamadrid SPAIN
T. 34 914 99 48 63
rubimadrid@rubi.com

PT **RUBI PORTUGAL**
Rua da Ribeira de Eiras, S/N, Armazém B
Ponte de Eiras
3020-324 Coimbra - PORTUGAL
T. 351 239 492 430
F. 351 239 492 431
rubiportugal@rubi.com

FR **RUBI FRANCE S.A.R.L.**
15 Avenue du Hoggar
Bâtiment le Vancouver
91940 LES ULIS - FRANCE
T. 33 1 69 18 17 85
T. 33 1 69 18 17 89
rubifrance@rubi.com

US **RUBI TOOLS USA Inc.**
10702 NW 147th Street, Suite 100
Hialeah Gardens, FLORIDA 33018 USA
P. 1 305 715 9892
F. 1 305 715 9898
rubitools.usa@rubi.com

UK **RUBI UK LTD.**
Units 16 & 17, Easter Park,
Ferry Lane
Rainham, Essex
RM13 9BP - UNITED KINGDOM
P. 44 (0) 1708559609
F. 44 (0) 1708553813
rubiuk@rubi.com

PL **RUBI POLSKA Sp. z o.o.**
ul. Dawidowska 10, Zamienie
05-500 Piaseczno
POLSKA
T. +48 (0) 226 44 51 61
F. +48 (0) 226 44 58 45
rubipolska@rubi.com

NL **RUBI BENELUX BV**
Weidehek, 70
4824 AS BREDA
LU NEDERLAND
BE T. 31 (0) 76 57 29 200
F. 31 (0) 76 57 20 190
rubibenelux@rubi.com

DE **RUBI DEUTSCHLAND GmbH**
Krahnendonk 89
AT 41066 Mönchengladbach
DEUTSCHLAND
T. 49 (0) 2161 990 60 90
F. 49 (0) 2161 478 12 69
rubideutschland@rubi.com

RU **RUBI ROSSIA**
моб. +7 903 153 30 46
тел.: +34 936806500
факс: +34 936806501
rubirossia@rubi.com

CA **RUBI CANADA**
9209 Boul Langelier
St-Léonard, Qc CA H1P-3K9
P. 1866 898 7924
rubicanada@rubi.com

IT **ITALIA**
T. 800 788278
F. 800 788279
commerciale@rubi.com

CN **Suzhou Rubi Technologies Co., Ltd.**
Block 2, No.86, Tinghe Road, SIP, Suzhou City,
Jiangsu, Province, China
Zip Code: 215121
中国江苏省苏州工业园区亭和路86号2号厂房
苏州瑞比机电科技有限公司
邮政编码: 215121
Tel: 86 512 66626100

IN **RUBI INDIA**
Andheri Kurla Road, Andheri (East)
Mumbai-400059, India
T.+91 22 67587457 60
rubinvestindia@rubi.com

MX **GERMANS BOADA MEXICO**
Av. Industria Moderna #2001 Bodega 82,
El Cerrito, CP 76240
El marqués, QRO
T: +52 55 5592 4907
T: +52 55 5592 5386
mexico@rubi.com

CO **RUBI COLOMBIA**
Cra. 11a #94-56, Oficina 501
Bogotá D.C. COLOMBIA
T. (+571) 749 85 08

CL **RUBI CHILE**
GERMANS BOADA S.A.
Los Militares # 5620, Oficina 1503
Los Condes (Santiago de Chile) CHILE
T. (+562) 3339 9193
T. (+569) 9799 9574
rubichile@rubi.com

AE **RUBI MIDDLE EAST**
P.O. Box 507070, Unit 08A, Level 7,
Al Fattan Currency House-Tower 1,
Dubai IFC, Dubai, United Arab Emirates
nkhan@rubi.com
T. +971 52 969 7852

TR **RUBI TURQUIA**
TAMER OZALLI Hird. Hizm.
Fulya Mah: Mehmetcik cad Kozacik sok
Birlik ap D:3 Şişli / İstanbul
T. +90 50 7624 0167
tozalli@rubi.com



Prices valid with exception of typing or printing errors. Photos are not contractual.
Electric and electronic equipment subject to recycling costs determined by an agent appointed by GERMANS BOADA, S.A.