

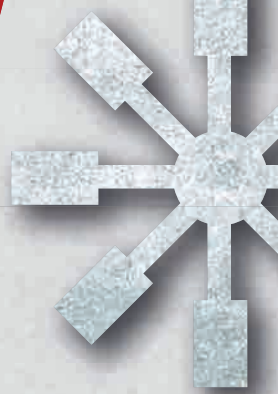

**world leader in
concrete vibrators**



2022/2023

PRODUCT CATALOGUE

VIBRATION - SURFACING - COMPACTION



www.enargroup.com

ENARCO is a spanish enterprise devoted to the design and manufacturing of light machinery equipment for concrete vibration. Since its foundation in 1964, its trajectory has positioned itself as a top leader within its sector, both in the national and international market, exporting and creating commercial networks across the five continents, along with its own subsidiaries, too.

The **ENAR** brand comprises 3 differentiated product ranges: **Vibration, Surfacing and Compaction**. High-quality products for covering all possible users' needs no matter the job to undergo. ENAR offers a great added value supported by its technical assistance service and sales team support.

**WE ARE
MANUFACTURERS**

MORE THAN
58
YEARS
OF EXPERIENCE



**since
1964**

**PROFESSIONAL SOLUTIONS
FOR CONCRETE VIBRATION WORKS**

FACTORY WARRANTY

STOCK AND AVAILABILITY

SPARE PARTS SERVICE

SALES SUPPORT

ENAR is committed to the development of battery-powered products and systems that ensure user safety.

The latest generation of technology and Lean methodology are applied in all our manufacturing processes. High standards of quality and certified processes backs us up.



- More than 1,000 clients worldwide.
- We export to more than 100 countries.
- Our commercial networks spans across all five continents, with own subsidiaries in Mexico, China, Poland, Colombia, USA and India.





VIBRATION RANGE

4



E-BATT RANGE

11



SURFACING RANGE

15

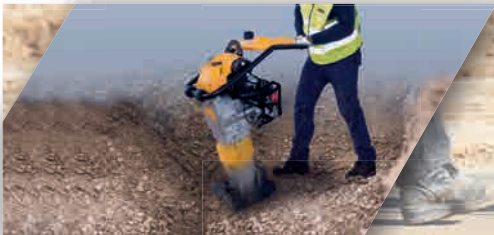

COMPACTION RANGE

21

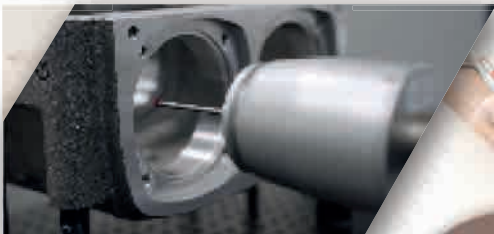

TECHNICAL DATA

25

VIBRATION RANGE



ENAR vibration equipment is characterized by its quality and high performance on the job. A complete offering consisting of eccentric, pendular, pneumatic, external and internal motor vibration machines that meets all the needs of the global market.

AVMU - DINGO - FOX



Lightness



Additional protection



Manageables



Easy maintenance



- Air filter incorporated.
- Carrying strap included.
- They work with AX eccentric poker heads (25-58mm) and TAX/TDX transmissions (0,6-6m).
- Transmission with increased protection at the poker's head connection end.
- 4 double-sealed oil-lubricated bearings for the AX poker heads.

EXPLORE THEM IN OUR WEBSITE



AVMU



DINGO



FOX

VIB-BAR / BACKPACK



Horizontal works



Cordless



Mobility



Lightness



TBX 0.5 TRANSMISSION REINFORCED WITH METAL STRIP

TOTAL MANAGEABILITY FROM THE HANDLE

- Throttle controller and stop button integrated in the handle.
- Harness for transport included.
- They work with AX45 poker heads.
- VIB-BAR E-BATT battery-powered model available. (page 8)



VIB-BAR



BACKPACK

M-AFP / MP-AFP POKERS



- › Standard lengths: 10 m. cable and 5 m. transmission for M-AFP / 15 m. and 0.8m. for MP-AFP PISTOL.
- › Safety voltage of 42V/3~200Hz.
- › Optional reinforced rubber nose available.
- › Vibration frequency: 12.000 v.p.m.
- › Hardened poker tube and nose.

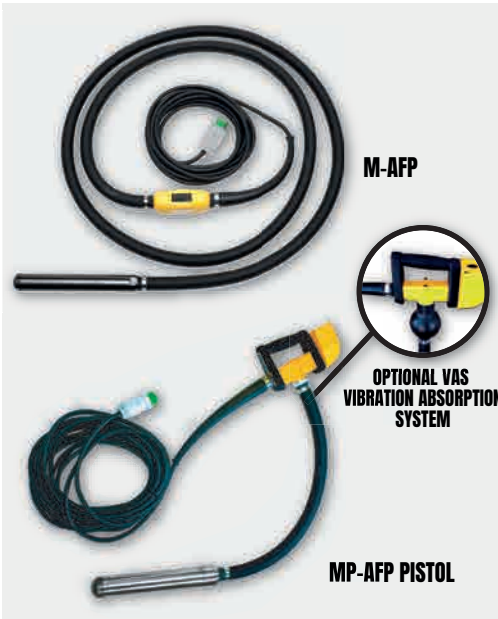

M-AFP



MP-AFP

AFE CONVERTERS



- › 5 meter cable.
- › Optional transport trolley.
- › Protective housing against external impacts and really simple to clean against concrete splashes.
- › Available in single-phase and three-phase connections.
- › Protection structure in steel tube.



AFE SUITCASE



AFE TUBULAR

BOXEL CONVERTERS



Reduced volume



Eco-Friendly



Lightness



Zero maintenance

- › The protective structure consists of rubber closures and aluminum handles.
- › 5 meter cable.
- › With a low safety voltage of 42V, there is no risk of electric shocks.
- › It can connect up to 3 M-AFP high-frequency pokers at the same time.
- › BOXEL E-BATT battery-powered model available. (page 9)

SPYDER CONVERTERS



Plug&Play



Safe and reliable



Ergonomic



Light and compact

- › Vibration frequency: 12,000 v.p.m.
- › Optional rubber poker end.
- › Pistol version available both for Spyder Pro and i-Spyder.
- › Optional VAS vibration absorption system available.

ROCKET CONVERTERS



Plug&Play



Economy of use



Zero maintenance



Light and compact

- › Progressive start to avoid current peaks, preventing deterioration.
- › Converter weight: 3.4kg.



BOXEL



SPYDER



ROCKET

VG ENGINES



Resistant



High performance



Complete range



Cordless

- › Shock-resistant steel frame.
- › Universal and hexagonal couplings available.
- › Possibility of connecting VOLGA pumps.
- › Different petrol and diesel engines available.



VG



Universal



Powerful



Robust and resistant

- › Flexible hose and submersible head.
- › Easy to use and low maintenance needed.
- › Aluminum pump case, submersible up to 6m.
- › Specially designed to absorb dirty water with solid fragments up to 13mm in diameter.



VOLGA

VPA ENGINES



Durability



Protective housing



Zero maintenance



Complete range

- › Engine speed: 3,000 r.p.m.
- › Complete range of single-phase and three-phase engines.
- › Different types of pins available upon request.
- › Three-phase motor provided with a clutch to prevent rotation in the opposite direction.



VPA

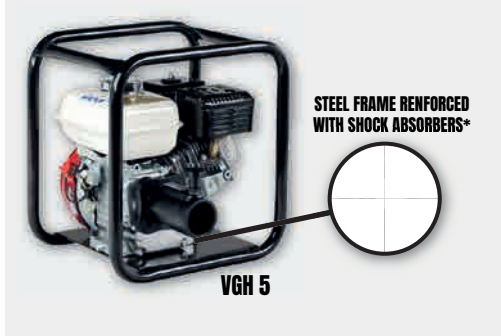

ANR/TNR PENDULUM VIBRATORS



Versatility



Adaptability



Resistant



ANR-TNR

- › Axis rotation frequency: 3,000 r.p.m.
- › Poker vibration frequency: 12,000 v.p.m.
- › Easy to use and low maintenance required.



TNR



ANR

PNU PNEUMATIC VIBRATORS



Versatility



No plugs
needed



Light and
compact



Resistant



- › Recommended working pressure: 6 bar.
- › The valve does not require maintenance.
- › Aluminium handle.
- › Long life oil tank.



PNU

AFG/AFD GENERATORS



Resistant



Complete range



Multiple
outputs



Cordless



- › 42V safety voltage.
- › AFGH 6000 model comes with a transport cart.
- › Electricity supply is not required.



AFG

EXTERNAL VIBRATORS



IP67 protection



Complete range

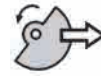

Adjustable force



Quick coupling

VET/VEM RANGES

- › 400 V3 ~ 50Hz connection (VET three-phase range).
- › 230 V1 ~ 50Hz connection (VEM single-phase range).
- › Oscillations: 3,000 r.p.m.
- › For all kinds of uses: Prefabricated, formwork, hoppers, tables, belts, vibrating screens...
- › The different models and the eccentric regulation allow adjustment to a wide range of needs (from 100kg to 1,500kg).

VEAF RANGE (HIGH FREQUENCY)

- › 42V ~ 50/60Hz connection (VEAF range).
- › 220V ~ 50/60Hz connection (VEAF with coupled Spyder).
- › Oscillations: 6,000 r.p.m.
- › Possibility of coupling a Spyder Pro or i-Spyder.
- › Clamps are also available for VET/VEM 100, 150 and 300 models.
- › The clamp counts with a safety strap.



VET/VEM RANGES

VEAF RANGE



VET/VEM



VEAF

TYPE A CLAMP (FLAT)



TYPE B CLAMP (SERRATED)



E-BATT RANGE

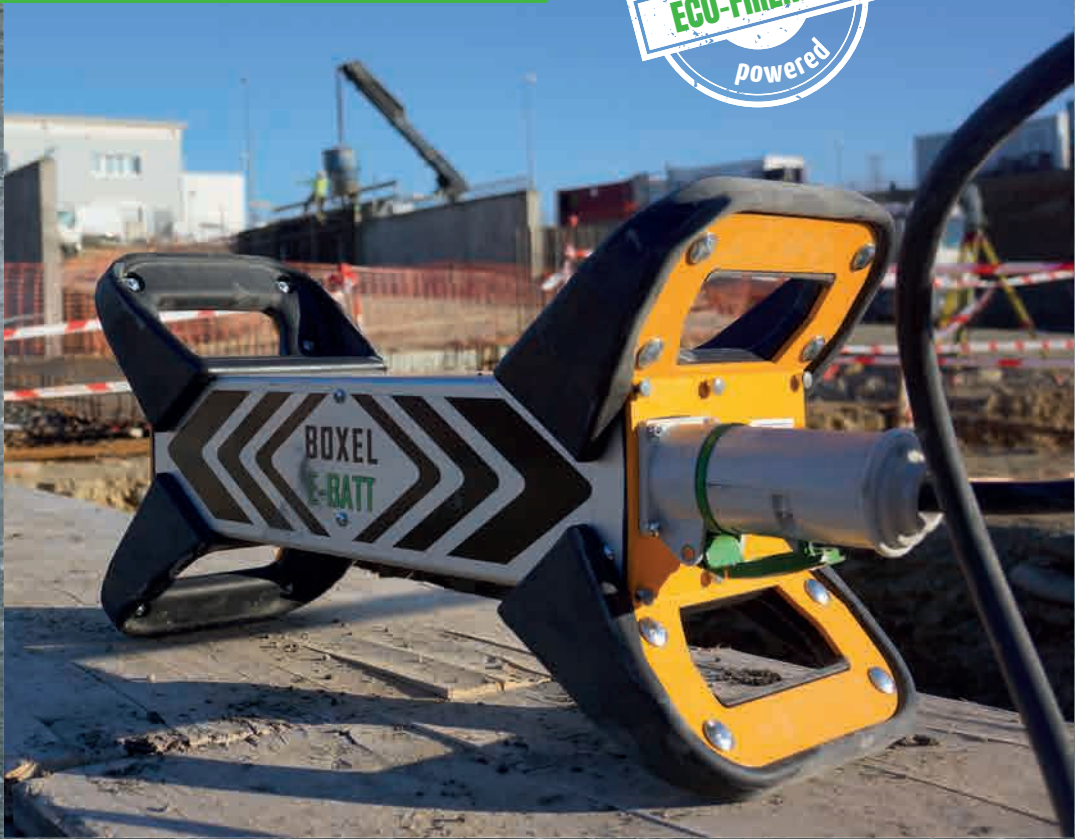

At ENAR, environmental awareness is of great importance. Therefore, our growing range of E-BATT battery products is already a reality, made up of innovative products designed after years of our own research and development. Sustainability and efficiency without sacrificing performance, lightness, or maneuverability.



VIB-BAR E-BATT VIBRATOR



THE SET INCLUDES
CARRYING STRAP,
CHARGER AND BATTERY

- Powerful ion-Li 58V 4Ah battery, which brings 1 hour of autonomy in continuous use, and includes a battery charge indicator display.
- Minimum maintenance required thanks to its battery power working system.
- It works with APB38 pendulum vibrators.
- Ideal for heavy-duty jobs.



VIB-BAR
E-BATT

THE VIB-BAR E-BATT IN ACTION



BOXEL E-BATT CONVERTER



Superior performance



Light and compact



Powerful battery



Zero maintenance



- › No cable nor petrol engine needed to work.
- › Great user's mobility, with an outstanding battery autonomy.
- › Protective structure composed of rubber closures and aluminum handles.
- › Powerful battery that brings up to 2 hours of autonomy in continuous use.
- › Also available with transport backpack.



**BOXEL
E-BATT**

THE BOXEL E-BATT IN ACTION



TORNADO E-BATT SCREED



Safe and
reliable



VAS system



Eco-Friendly



Zero
maintenance

- › Profiles going from 1.5m to 4m.
- › Handlebar equipped with stop switch.
- › The frame protects the motor from concrete splashes.
- › It maintains the robustness, manageability and ergonomics that define the entire ENAR TORNADO series.
- › With its low noise level, it is ideal for environments with noise restrictions, such as city centers.



TORNADO
E-BATT

THE TORNADO E-BATT IN ACTION



SURFACING RANGE



The quality and homogeneity in the paving with concrete is gaining more importance every day. With the commitment to obtain the best results in any circumstance, ENAR offers a complete range for the vibration and superficial leveling of concrete floors.

QX SCREEDS



**Economy
of use**



**Robust and
resistant**



**Light and
manageable**



**Complete
range**

- » Profiles going from 1.5m to 4m.
- » It offers a perfect value for money considering its performance.
- » Improved design of the handle to bring more robustness and resistance.
- » Wide variety of electric and fuel-powered engines.



QX

TORNADO SCREEDS



**Safe and
comfortable**



Ergonomic

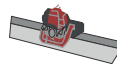

**Engine
support**



VAS system

- » Profiles going from 1.5m to 4m.
- » Handlebar equipped with stop switch.
- » A vibration-reducing system provides a more comfortable handling experience.
- » The frame protects the motor from concrete splashes.
- » Optional grips with VAS anti-vibration system.
- » TORNADO E-BATT battery-powered model available. (page 10)



TORNADO H



TORNADO

HURACAN SCREEDS



Ergonomic



Durability



Foldable



VAS system

- › Profiles going from 2m to 5m.
- › Optional VAS vibration absorption system.
- › Stop button integrated in the handle.



HURACAN

QZ SCREEDS



Oscillating profile



Accessibility



Bidirectional



Complete range

- › Rotating system integrated in the handle, which also enables changing angle of the screed.
- › Profiles going from 2m to 4m.



QZ

MISTRAL SCREEDS



Durability



Manageability



Integrated throttle



Engine support

- › Profiles going from 1.5m to 4m.



MISTRAL

QP/QG DOUBLE SCREEDS



- Product designed to work on level guides or rails on large surfaces.
- Equipped with rings at the ends of the profile to facilitate the dragging task.
- The lower weight of its drive unit improves the flatness of the finish.
- Profiles going from 2.5m to 6m.

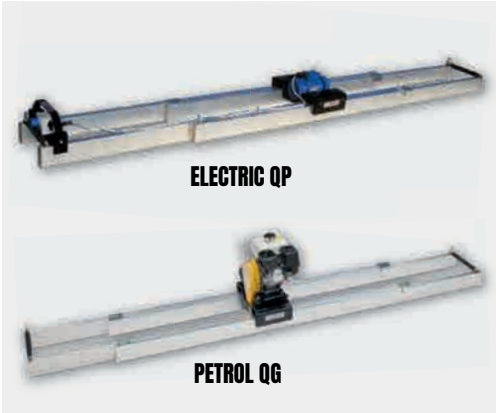

QG



QP

SCREED PROFILES



"L" PROFILES

- Profiles going from 1.5m to 4m.
- Rounded profile edges with anti-corrosion treatment.
- 200mm profile base designed to provide good buoyancy.

"QZ/HURACAN" PROFILES

- Profiles going from 2m to 5m.
- Curved profile's shape to push and drag the concrete.

DOUBLE PROFILES

- Profiles going from 2.5m to 6m.
- Adjustable profile to the width of the area to be compacted.
- Fixed-type and extensible-type profiles available.

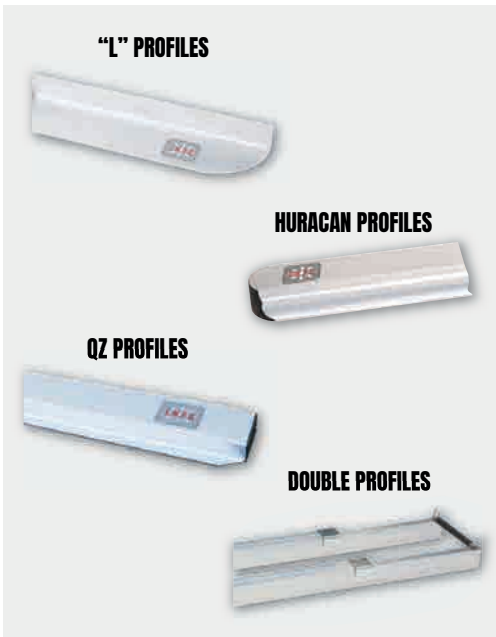

TIFON TROWELS



› Float disc and set of 4 finishing blades (For TIFON 900/1200 combined and/or floating) included.



TIFON

TIFON 908 DOUBLE TROWEL

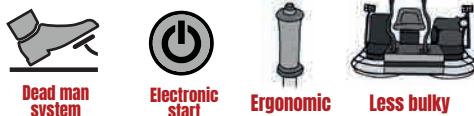

- › Water and fuel tanks made of stainless steel.
- › Lighting system with two LED spotlights.
- › Greater compactness to improve its transport and volume.
- › Easy access to oil change without removing the engine.



**TIFON
908**

BULL FLOATS



- › The ENAR bull floats are available in lengths of 0.9, 1.2 and 1.8 meters with both a fixed handle and an oscillating handle for working in both directions.
- › The new aluminum handle is interchangeable with both models and allow to fit several units for a longer handle length.
- › The Brush Kit can be installed on both fixed and oscillating bull floats and can be offered in diverse lengths (0.9, 1.2 and 1.8 metres long).
- › The Suitcase Kit includes 1 magnesium profile, 1 oscillating group, 4 aluminum handles and 1 robust transport case. It can be offered with different bull float sizes: (0.9, 1.2 y 1.8 metres long).



BULL FLOATS

TROWELS



- › Complete range of trowels with steel profiles, fixed and oscillating connections.
- › The new aluminum handle is interchangeable with both models and allow to fit several units for a longer handle length.
- › ENAR trowels are available in lengths of 0.6, 0.75 and 1.2 for the standard width models, and in length of 1.2m for the special width Blue Glider model.



TROWELS

COMPACTION RANGE



ENAR's light compaction range is one of the best options on the market due to its robust designs, multiple configurations, low maintenance costs, and high levels of safety and performance.

DEEP TAMPING RAMMERS



Air filter



Comfort of use



Noise reduction



Economic maintenance



- › Foot dimensions: 332x280 mm.
- › 650 hits per minute.
- › Tachometer with optional operating hours and engine revolutions indicator.
- › Different models between 65 and 80kg with petrol and diesel engines.
- › Optional air filter saturation sensor.
- › Large 3-stage air filter.



DEEP

ZEN FORWARD PLATE COMPACTORS



Simple transport



Sturdy base



Complete range



Ergonomics



ZEN

ZEN-E

- › Vibration frequency: 5,600 vib/min.
- › Accelerator integrated in the handle.
- › Different manufacturers' petrol and diesel engine options.
- › Removable handle to facilitate the transport of the machine (ZEN-E).
- › Optional 9L water tank provided with quick assembly and disassembly system for easy filling.
- › Optional polyurethane sheet for paving stone compaction.
- › Easy start-up through a centrifugal clutch.



ZEN



ZEN-E

TEN REVERSIBLE PLATE COMPACTORS



- › Eccentric system to easily adjust the belt tensioning.
- › Optional polyurethane sheet for paving stone compaction.
- › Optimized engine for demanding jobs.
- › Optional transport system.
- › Easy draining of engine oil.
- › Optimum frequency and amplitude for compaction.
- › Dead man safety system.
- › Electric start of both petrol and diesel machines.



TEN 25/30



TEN 35

CRENA REVERSIBLE PLATE COMPACTORS



- › Excellent performance in large jobs.
- › Dead man safety system.
- › Optional electric start.
- › Different petrol and diesel engine options.



CRENA

REN WALK-BEHIND ROLLERS



**Sprinkler
system**



Maneuverability



**Optimized
design**



Safety



REN 650DK

- › Accessibility to small spaces.
- › Hydraulic transmission system with independent motors for each roller. (REN 650DK)
- › Water tank capacity: 45l.
- › Electric starting system for diesel engine.
- › Chain transmission system.
- › Front auxiliary lighting. (REN 650DK)
- › Dead man safety system.
- › Lifting point to facilitate loading and unloading.



REN 650



ECCENTRIC VIBRATORS (Page 5)

MODEL	WEIGHT	TENSION	FREQUENCY	POWER	DIMENSIONS
AVMU 230V	5 kg	230V 1 ~	50-60 Hz	2,300 W	354x150x205
DINGO 230V	5.8 kg	230V 1 ~	50-60 Hz	2,300 W	345x244x229
FOX 230V	5.8 kg	230V 1 ~	50-60 Hz	2,300 W	354x150x216

*115V version of the 3 models above is available upon request (1,800W).

AX POKERS (Page 5)

MODEL	WEIGHT	DIAMETER	LENGTH	SPEED	PERFORMANCE
AX 25	0.8 kg	25 mm	285 mm	14,000 r.p.m.	10 m ³ /h
AX 32	1.7 kg	32 mm	366 mm	13,750 r.p.m.	14 m ³ /h
AX 40	2.2 kg	40 mm	335 mm	13,500 r.p.m.	17 m ³ /h
AX 45*	3 kg	45 mm	325 mm	9,500 r.p.m.	25 m ³ /h
AX 48	3.2 kg	48 mm	335 mm	12,500 r.p.m.	28 m ³ /h
AX 58	4.5 kg	58 mm	344 mm	12,000 r.p.m.	35 m ³ /h

*Poker for VIB-BAR and BACKPACK models.

PORTABLE PETROL-POWERED VIBRATORS (Page 5)

MODEL	WEIGHT	POWER	ENGINE	CAPACITY	FUEL	SPEED	POKER
VIB-BAR H BACKPACK	6-7 kg	1.6 CV	HONDA GX35 4T	35.8 CC	Unleaded Petrol	10,000 r.p.m.	AX45

*VIB-BAR: Corresponds TBX 0.5 transmission. **BACKPACK: Correspond TDX/TDXE 2 and 3 transmissions.

FLEXIBLE TRANSMISSIONS (Page 5)

MODELS	LENGTH	WEIGHT
TAX/TAXE/TDX/TDXE 0.6	0.6 m	2.6 kg
TAX/TAXE/TDX/TDXE 1	1 m	3 kg
TAX/TAXE/TDX/TDXE 1.5	1.5 m	3.5 kg
TAX/TAXE/TDX/TDXE 2	2 m	4 kg
TAX/TAXE/TDX/TDXE 2.5	2.5 m	4.5 kg
TAX/TAXE/TDX/TDXE 3	3 m	5 kg
TAX/TAXE/TDX/TDXE 4	4 m	6 kg
TAX/TAXE/TDX/TDXE 5	5 m	7 kg
TAX/TAXE/TDX/TDXE 6	6 m	8 kg

*TAXE/TDXE: Corresponding pokers AX25 and AX32.

**TAX/TDX: Corresponding pokers AX40, AX48 and AX58.

PORTABLE BATTERY-POWERED VIBRATORS (Page 12)

MODEL	WEIGHT	POWER	ENGINE	BATTERY	AUTONOMY	CHARGE	POKER
VIB-BAR E-BATT	5 kg	MAX. 800W	Electric	ion-Li 58V 4Ah	Up to 1 hour	1 hour	APB38

*Corresponds APB38 pendulum poker and TBP 0.5 transmission.

BATTERY-POWERED ELECTRONIC CONVERTER BOXEL E-BATT (Page 13)

MODEL	DIMENSIONS	WEIGHT	BATTERY					OUTPUT	
			Ah	V	Wh	CELL TYPE	DURATION	TENSION	FREQUENCY
BOXEL E-BATT	540x290x200mm	11 kg	15.9	68.4	1087	Li-ion	120 min*	42V	200Hz

*The battery life is indicative, and it may vary depending on the type of concrete, temperature and work cycle.

BOXEL ELECTRONIC CONVERTERS (Page 7)

MODEL	DIMENSIONS	WEIGHT	NUMBER OF PLUGS	INPUT			OUTPUT			CONNECTIONS*		
				POWER	INTENSITY	TENSION	POWER	INTENSITY	TENSION	M38/M5	M6	M7/M8
BOXEL 215	480x310x180mm	10 kg	2	1.7KW	7.5 A	230V 1-50Hz	1.5KVA	21 A	42 V3~200 Hz	x2	x1	x1
BOXEL 225	530x310x180mm	11 kg	2	2.8KW	12.5 A	230V 1-50Hz	2.5KVA	31 A	42 V3~200 Hz	x2	x1	x2
BOXEL 325	530x310x180mm	11 kg	3	2.8KW	12.5 A	230V 1-50Hz	2.5KVA	31 A	42 V3~200 Hz	x3	x1	x2

* Number of M-AFP ENAR pokers that can be connected at the same time to each BOXEL model.

M/MP-AFP HIGH FREQUENCY POKERS (Page 6)

MODEL	DIAMETER	LENGTH	INTENSITY	WEIGHT	WEIGHT PISTOL MODEL	PERFORMANCE	ACCELERATION WITHOUT VAS	ACCELERATION WITH VAS
M/MP 38 AFP	38 mm	370 mm	8 A	11 kg	8 kg	Up to 20 m ³ /h	1.18 m/s ²	0.34 m/s ²
M/MP 5 AFP	50 mm	365 mm	10.5 A	13 kg	10 kg	Up to 30 m ³ /h	2.02 m/s ²	0.46 m/s ²
M/MP 6 AFP	58 mm	403 mm	15 A	15 kg	13 kg	Up to 35 m ³ /h	1.95 m/s ²	0.39 m/s ²
M/MP7 AFP	65 mm	365 mm	22 A	16 kg	15 kg	Up to 40 m ³ /h	2.44 m/s ²	0.49 m/s ²
M8 AFP	75 mm	385 mm	18A	18 kg	-	Up to 45 m ³ /h	-	-

*Connection to 240Hz converters available upon request. **Available in MP-AFP pistol model.

AFG/AFD HIGH FREQUENCY GENERATORS (Page 9)

MODEL	WEIGHT	NUMBER OF PLUGS	ENGINE	OUTPUT	
				POWER	TENSION/FREQUENCY
AFGH 2000	20 kg	1	HONDA GX160 5.5 cv/Hp	-	-
AFDY 2000	23 kg	1	YANMAR L48AE 4.7 cv/Hp	1.6 KVA 24A	42 V3 ~ 200 Hz
AFDL 2000	32 kg	2	LOMBARDINI 225 4.8 cv/Hp	-	-
AFGH 6000	30 kg	2	HONDA GX390 12 cv/Hp	6 KVA 83A	42 V3 ~ 200 Hz

*Other engines available upon request.





AFE HIGH FREQUENCY CONVERTERS (Page 6)

MODEL	WEIGHT	NUMBER OF PUGS	INPUT		OUTPUT		TRANSPORT TROLLEY
			POWER	TENSION/FREQUENCY	POWER	TENSION/FREQUENCY	
AFE 1000M P	20 kg	1	1.3 KW 6A	230V 1 ~ 50Hz	1.0 KVA 13A	42 V3 ~ 200 Hz	Not available
AFE 2000M P	29 kg	2	2.0 KW 9A	230V 1 ~ 50Hz	1.6 KVA 23A	42 V3 ~ 200 Hz	Not available
AFE 2000 P	29 kg	2	2.8 KW 4A	400V 3 ~ 50Hz	1.6 KVA 23A	42 V3 ~ 200 Hz	Not available
COMPACT 1000M	20 kg	1	1.3 KW 6A	230V 1 ~ 50Hz	1.0 KVA 13A	42 V3 ~ 200 Hz	Not available
AFE 1000MT	23 kg	1	1.3 KW 6A	230V 1 ~ 50Hz	1.0 KVA 13A	42 V3 ~ 200 Hz	Optional
AFE 2000MT	32 kg	2	2.0 KW 9A	400V 3 ~ 50Hz	1.6 KVA 23A	42 V3 ~ 200 Hz	Optional
AFE 2000T	30 kg	2	2.8 KW 4A	400V 3 ~ 50Hz	1.8 KVA 25A	42 V3 ~ 200 Hz	Optional
AFE 2500T	34 kg	3	4 KW 6A	400V 3 ~ 50Hz	2.5 KVA 35A	42 V3 ~ 200 Hz	Optional
AFE 3500	59 kg	3	5 KW 7A	400V 3 ~ 50Hz	3.5 KVA 50A	42 V3 ~ 200 Hz	Integrated
AFE 4500	68 kg	4	7 KW 10A	400V 3 ~ 50Hz	4.5 KVA 61A	42 V3 ~ 200 Hz	Integrated
AFE 6000	75 kg	4	8 KW 12A	400V 3 ~ 50Hz	6 KVA 82A	42 V3 ~ 200 Hz	Integrated

SPYDER INTEGRATED ELECTRONIC CONVERTERS (Page 7)

MODEL	POKER DIAMETER	POKER LENGTH	INPUT	WEIGHT	PERFORMANCE
SPYDER PRO 38 i-SPYDER 38 ROCKET 38	38 mm	370 mm	0.75 KW	13-14 kg	Up to 20 m ³ /h
SPYDER PRO 50 i-SPYDER 50 ROCKET 50	50 mm	365 mm	1.1 KW	17-18 kg	Up to 30 m ³ /h
SPYDER PRO 60 i-SPYDER 60 ROCKET 60	58 mm	403 mm	1.5 KW	19-20 kg	Up to 35 m ³ /h
SPYDER PRO 70 i-SPYDER 70	65 mm	365 mm	1.9 KW	20-21 kg	Up to 40 m ³ /h

*All the i-SPYDERs are available both in Switch version and Button version.

**Available in 110V~50/60Hz configuration upon request.

VET/VEM/VEAF EXTERNAL VIBRATORS (Page 10)

MODEL	WEIGHT	CENTRIFUGAL FORCE	RATED CURRENT	DIMENSIONS CxDxE	DIMENSIONS AxB	CABLE
VET 100	4.6 kg	99 kg	0.2 N	212x130x126 mm	62-74x106 mm	2 m
VET 150	6.8 kg	198 kg	0.35 N	212x131x159 mm	62-74x106 mm	1 m
VET 300	9.8 kg	311 kg	0.52 N	253x155x175 mm	90x125 mm	1 m
VET 600	15.8 kg	516 kg	0.96 N	334x168x196 mm	105x140 mm	1 m
VET 800	20.6 kg	788 kg	1.45 N	321x208x210 mm	120x170 mm	1 m
VET 1600	51.6 kg	1,571 kg	2.94 N	416x229x262 mm	140x190 mm	1 m
VEM 100	2.1 kg	99 kg	0.5 N	221x130x136 mm	62-74x106 mm	2 m
VEM 150	6.8 kg	197 kg	1.1 N	231x130x259 mm	62-74x106 mm	1 m
VEM 300	9.8 kg	311 kg	1.15 N	255x130x177 mm	90x125 mm	1 m
VEAF 650	9 kg	670 kg	7.3 A	249x160x126 mm	125x90 mm	15 m

*Possibility of coupling a Spyder Pro or i-Spyder. (Those ones have a 230V~50/60Hz connection supply versus the 42v of the standard VEAF models)

PNU PNEUMATIC VIBRATORS (Page 9)

MODEL	WEIGHT	LENGTH	DIAMETER	SPEED	PERFORMANCE	CENTRIFUGAL FORCE	CONSUMPTION
PNU25	2.5 kg	220 mm	25 mm	20,000 r.p.m.	5 m ³ /h	700 N	400 l./min
PNU45	5.3 kg	330 mm	45 mm	18,000 r.p.m.	18 m ³ /h	3,200 N	750 l./min
PNU60	10 kg	340 mm	65 mm	17,000 r.p.m.	28 m ³ /h	9,000 N	1,000 l./min
PNU80	13 kg	360 mm	75 mm	15,000 r.p.m.	38 m ³ /h	12,000 N	1,250 l./min
PNU100	18 kg	390 mm	100 mm	13,500 r.p.m.	55 m ³ /h	22,000 N	2,000 l./min

*Other lengths available upon request.

PENDULUM VIBRATORS (Page 9)

MODEL	WEIGHT	LENGTH	DIAMETER	PERFORMANCE
TNR+ANR25	9.2 kg	350 mm	25 mm	10 m ³ /h
TNR+ANR38	18.3 kg	375 mm	38 mm	15 m ³ /h
TNR+ANR48	20.1 kg	445 mm	48 mm	25 m ³ /h
TNR+ANR58	22.2 kg	450 mm	58 mm	30 m ³ /h
TNR+ANR70	23.3 kg	510 mm	70 mm	35 m ³ /h

*Transmission lengths available: 4 and 6m. (Others upon request).

ENGINES FOR PENDULUM VIBRATORS (Page 8)

MODEL	WEIGHT	FUEL	ENGINE	POWER
VGH 5 VGR 6 VGE 5	21.5-22 kg	Petrol	HONDA GX160 ROBIN EX-17 DU ENAR G200	5.5-5.7 CV
VHD VVD	35-38 kg	Diesel	HATZ IB 20 YANMAR L48	4.5-4.7 CV

*Shock absorber available for VGH 5, VHD and VVD models.

ELECTRIC ENGINES FOR PENDULUM VIBRATORS (Page 8)

MODEL	TENSION	FREQUENCY	POWER	DIMENSIONS
VPA D	400V 3~			
VPAM D	230V 1~	50 Hz	1.5 CV	440x190x340 mm
VPAME D	115V 1~			

*Connection 60 Hz and different types of pins available upon request.

VOLGA WATER PUMP (Page 8)

MODEL	WEIGHT	OUTPUT DIAMETER	DIMENSIONS	SOLIDS	PRESSURE HEIGHT	MAX. FLOW
VOLGA	5 kg	3" (75mm)	265x195x240 mm	13mm Ø max.	17	900 l./min



PETROL-POWERED SCREEDS (Page 16-17-18)

MODEL	WEIGHT	ENGINE	POWER	FUEL	FUEL TANK CAPACITY	FREQUENCY	CENTRIFUGAL FORCE
QX H	9.8 kg	HONDA EHO25 4t/st	1.1 CV	Unleaded Petrol	0.5 L	Up to 9,000 v.p.m.	1,500 N
HURACAN H	14.5 kg	HONDA GX35 4t/st	1.6 CV	Unleaded Petrol	0.7 L	Up to 9,500 v.p.m.	2,000 N
TORNADO H	12.2 kg						
QZ H	9.8 kg	HONDA GX25 4t/st	1.1 CV	Unleaded Petrol	0.5 L	Up to 9,000 v.p.m.	1,500 N
MISTRAL H	10.7 kg						
QG H	47.2 kg	HONDA GX160 4t/st	5.4 CV	Unleaded Petrol	3.1 L	Up to 6,000 v.p.m.	3,000 N

"L" PROFILES

LENGTH	WEIGHT	LENGTH	WEIGHT
1.5 m	4.6 kg	2 m	8.2 kg
2 m	6.2 kg	3 m	12.6 kg
2.5 m	7.8 kg	4 m	16.8 kg
3 m	9.3 kg	5 m	21 kg
4 m	12.5 kg		

HURACAN PROFILES
ELECTRIC SCREEDS (Page 16-17-18)

MODEL	WEIGHT	ENGINE	POWER	FREQUENCY	CENTRIFUGAL FORCE
QX E TORNADO E QZ E	8-10.5 kg	External Vibrator 230V 1~	125-135 W	3,000 v.p.m.	700 N
QX E TURBO TORNADO E TURBO QZ E TURBO	+12 kg	Electric 230V 1~	500 W	12,000 v.p.m.	1,300 N
QP E	29.8 kg	External Vibrator 380V 3~	275 W	3,000 v.p.m.	3,000 N
QP E M	30 kg	External Vibrator 230V 1~	250 W		

*115V version available upon request.

DOUBLE PROFILES

LENGTH	WEIGHT	MATERIAL	DISTANCE BW. PROFILES
2.5-4.5 m	4.6 kg	Aluminium	270 mm
2.5-4.5 m	6.2 kg	Aluminium	270 mm
3.5-6 m	7.8 kg	Steel	270 mm

*Double profiles are available both in fixed-type and extensible-type configurations.

BATTERY-POWERED SCREEDS (Page 14)

MODEL	WEIGHT	ENGINE	POWER	FREQUENCY	CENTRIFUGAL FORCE	RATED CURRENT	BATTERY TENSION	CHARGING TIME
TORNADO E-BATT	12 kg	External Vibrator 24V	130 W	5,500 v.p.m.	1,400 N	14.5 hg	24 V	+3h

TIFON TROWELS (Page 19)

MODEL	DIAMETER	ENGINE	POWER	WEIGHT	SPEED
TIFON 601 602	600 mm	HONDA GX160 ENAR G200	5.5-6.5 CV	52 kg	120 r.p.m.
TIFON 909 910 907	900 mm	HONDA GX160 ENAR G200 HONDA GX270	5.5-8.4 CV	80-83.5 kg	127 r.p.m.
TIFON 1201 1203 1204	1200 mm	HONDA GX270 HONDA GX390 ENAR G390	8.4-13 CV	104-110 kg	135 r.p.m.

* Other engines available upon request.

TIFON 908 DOUBLE TROWEL (Page 19)

MODEL	WEIGHT	ENGINE	POWER	MAX SPEED	WORKING SPEED
TIFON 908	280 kg	HONDA GX690 4t/st	21-24 Hp	3,800 r.p.m.	70-127 r.p.m.
WORKING DIMENSIONS	NUMBER OF BLADES	FUEL TANKS CAPACITY	DIMENSIONS		
1,840 mm	8	17 L	2050x1800x1000 mm		

BULL FLOATS (Page 20)

MODEL	WEIGHT	LENGTH	PROFILE WIDTH	TYPE
TR 900 MG	4.4 kg	0.9 m	205 mm	Fixed
TR 1200 MG	5.6 kg	1.2 m		
TR 1800 MG	6.8 kg	1.8 m		
TRO 900 MG	4.6 kg	0.9 m		
TRO 1200 MG	5.8 kg	1.2 m	205 mm	Oscillating
TRO 1800 MG	7 kg	1.8 m		

HAND TROWELS (Page 20)

MODEL	WEIGHT	LENGTH	PROFILE WIDTH	TYPE
LR 600 A	4.1 hg	0.6 m	127 mm	Fixed
LR 750 A	4.3 hg	0.75 m		
LR 900 A	4.5 hg	0.9 m		
LR 1200 A	6 hg	1.2 m		
LRO 600 A	4.1 hg	0.6 m	127 mm	Oscillating
LRO 750 A	4.3 hg	0.75 m		
LRO 900 A	4.5 hg	0.9 m		
LRO 1200 A	6 hg	1.2 m		
B6 1200	7.4 hg	1.2 m	315 mm	Blue Glider

ACCESSORIES (Page 20)

MODEL DESCRIPTION	WEIGHT	LENGTH
EXTENDER EAL 50	0.55 hg	500x100 mm
ALUMINIUM HANDLE	0.55 hg	1.8 m
UNIVERSAL SUPPORT	-	-
BRUSH B 900	-	0.9 m
BRUSH B 1200	-	1.2 m
BRUSH B 1800	-	1.8 m
SUITCASE KIT	-	0.9/1.2/1.8 m





DEEP TAMPING RAMMERS (Page 22)

MODEL	WEIGHT WITHOUT FUEL	WORKING ELEVATION	IMPACT FORCE	ENGINE	SPEED	POWER	PERFORMANCE	FUEL
PH 60H	64 kg	60 mm	1,300 kg	HONDA GX100	4,000 r.p.m.	3 CV	190 m ²	Petrol
PH 70E 70LC	73-74 kg	70 mm	1,540 kg	HONDA GX120RT KR EE ENAR G165F 4CV	3,600 r.p.m.	4 CV	210 m ²	Petrol
PH 80YD	81 kg	70 mm	1,510 kg	YANMAR L 48 AE	3,600 r.p.m.	4 CV	205 m ²	Diesel

ZEN/ZEN-E FORWARD PLATE COMPACTORS (Page 22)

MODEL	WEIGHT WITHOUT FUEL	CENTRIFUGAL FORCE	DIMENSIONS	SPEED	PLATE LENGTH	ENGINE
ZEN 16/20 CGH/CGL DGH/DGL	90-94 kg	16-20,000 N	430x1165x958 mm 500x1165x958 mm	22-23 m/min	415 mm	HONDA GX160 ENAR G200F
ZEN 16/20 CDH DDH	106-110 kg	16-20,000 N	430x1165x958 mm 500x1165x958 mm	22-23 m/min	415 mm	HATZ DIESEL 1B 20
ZEN 16/20 CGHE/CGLE DGHE/DGLE	82-86 kg	16-20,000 N	430x952x890 mm 500x952x890 mm	22-23 m/min	415 mm	HONDA GX160 ENAR G200F

TEN/CRENA REVERSIBLE PLATE COMPACTORS (Page 23)

MODEL	WEIGHT WITHOUT FUEL	CENTRIFUGAL FORCE	FREQUENCY	DIMENSIONS	SPEED	PLATE LENGTH	ENGINE	POWER	START
TEN 2540 GR GH	134 kg	24,500 N	5,400 vib/min	400x1095x1171 mm	0-22 m/min	650 mm	ROBIN EX17 HONDA GX160	5.4-5.7 cv	Manual
TEN 2550 GR GH	140 kg	24,500 N	5,400 vib/min	500x1095x1171 mm	0-22 m/min	650 mm	ROBIN EX17 HONDA GX160	5.4-5.7 cv	Manual
TEN 3040 DH 3050 DH	148-156 kg	29,500 N	5,300 vib/min	500x1095x1171 mm	0-20 m/min	650 mm	HATZ DIESEL 1B20	4.6 cv	Manual
TEN 35 GH GHEL	205-210 kg	35,000 N	4,500 vib/min	900x550x1100 mm	0-22 m/min	650 mm	HONDA GX270	8.6 cv	Manual Electric
TEN 35 DH DHEL	215-220 kg	35,000 N	4,500 vib/min	900x550x1100 mm	0-22 m/min	650 mm	HATZ DIESEL 1B30	7.4 cv	Manual Electric
CRENA 26 GH DH	160-170 kg	26,000 N	5,700 vib/min	450x1220x1000 mm	0-22 m/min	700 mm	HONDA GX200 HATZ DIESEL 1B20	4.6-5.5 cv	Manual
CRENA 32 GH DH	210-215 kg	32,000 N	5,400 vib/min	500x1290x1040 mm	0-22 m/min	750 mm	HONDA GX200 HATZ DIESEL 1B20	4.6-5.5 cv	Manual
CRENA 52 GH	330 kg	52,000 N	4,500 vib/min	600x1420x1055 mm	0-22 m/min	895 mm	HONDA GX270	9 cv	Manual
CRENA 63 GH DH	430-440 kg	63,000 N	4,200 vib/min	750x1500x1040 mm	0-20 m/min	900 mm	HONDA GX390 HATZ DIESEL 1B50	11-12 cv	Manual
CRENA 63 GHE DHE	430-460 kg	63,000 N	4,200 vib/min	750x1500x1040 mm	0-23 m/min	900 mm	HONDA GX390 HATZ DIESEL 1B50	11-12 cv	Electric

REN WALK-BEHIND COMPACTION ROLLERS (Page 24)

MODEL	WEIGHT	CENTRIFUGAL FORCE	SPEED		POWER	FREQUENCY	ENGINE	FUEL	START
			FORWARD	BACKWARD					
REN 550GH	550 kg	12 kN	0-5 m/min	0-2 m/min	4.8 kW	60 Hz	HONDA GX200	Petrol	Manual
REN 600DH	585 kg	12 kN	0-5 m/min	0-2 m/min	3.2 kW	60 Hz	HATZ DIESEL 1B20	Diesel	Electric
REN 650DK	640 kg	10.8 kN	0-3.5 m/min	0-3.5 m/min	4 kW	60 Hz	KUBOTA E75NB3	Diesel	-



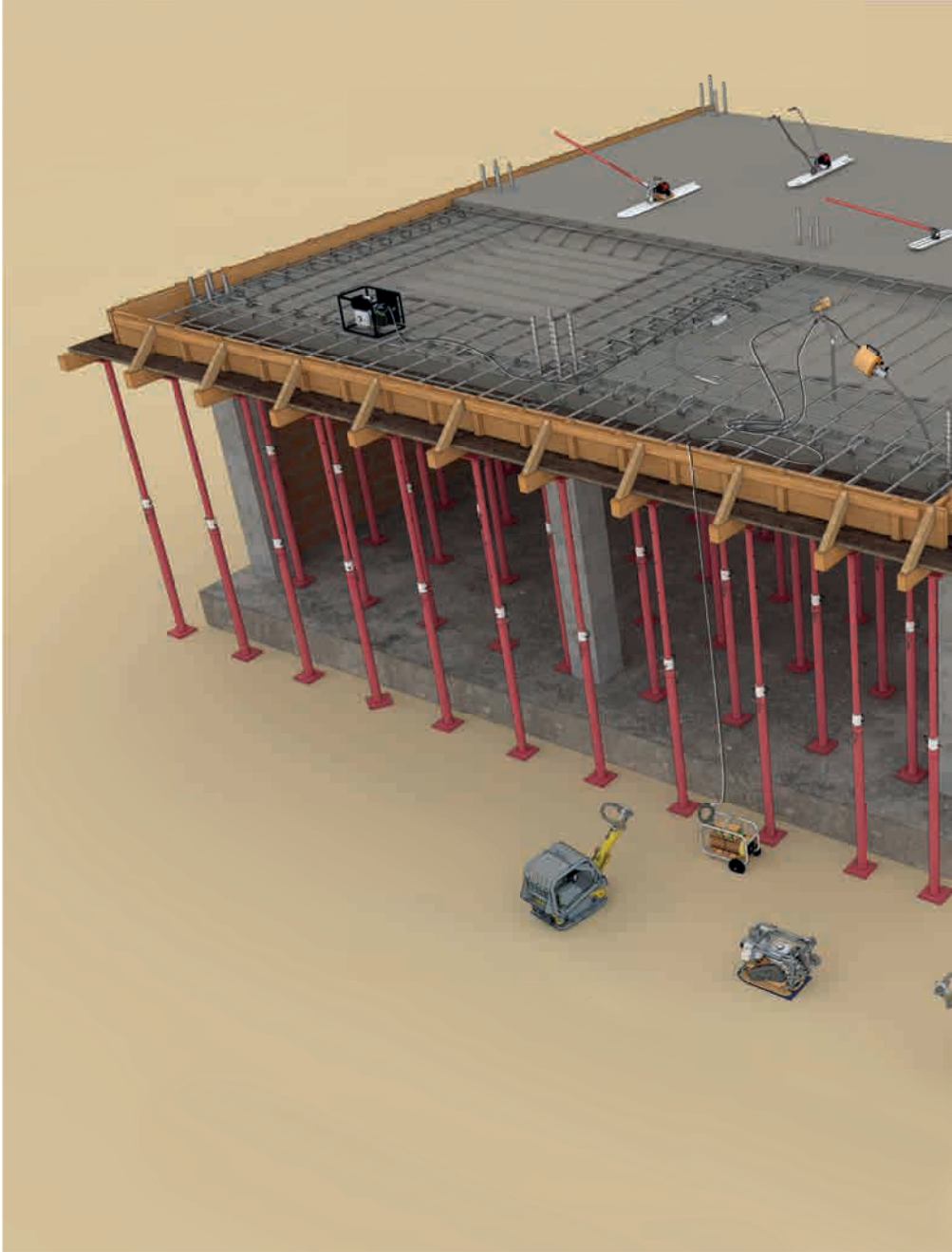





**world leader in
concrete vibrators**



ENARCO, S.A.

Calle Burtina, 16

Plataforma Logística PLAZA

50197 Zaragoza (SPAIN)



www.enargroup.com