

Dantherm[®]
CLIMATE SOLUTIONS



PORTABLE CONDENSATION DEHUMIDIFIERS

CDT 30-30S-40-40S-60-90

IDEAL FOR RENTAL AND CONSTRUCTION COMPANIES

DANTHERMGROUP

About the Dantherm Group

Originally founded in 1954, the Dantherm Group is a European leader in portable and installed climate control solutions for a wide range of industries and uses. Based on the work of more than 500 passionate climate control experts and more than three million installations, our competence centres around Europe design and build exceptional heating, cooling, dehumidification and ventilation units that form the backbone of these climate solutions. In everything they do, they remain focused on creating healthy and comfortable climate surroundings in a sustainable, energy-efficient and cost-effective way.



Five competence centres in Denmark, Germany, Italy, Spain and UK.

Competence centre
for portable drying solutions: Norderstedt, Germany.



Our drying competence centre near Hamburg, Germany, has more than 30 years of experience in developing innovative and user-friendly dehumidifiers and drying solutions that are renowned for their sturdiness, flexibility and hassle-free operation.

CDT SERIES – MOBILE DEHUMIDIFICATION

QUICK AND EASY HUMIDITY CONTROL



Dantherm mobile CDT dehumidifiers offer quick and easy control for water damage restoration companies and the construction industry. The units are renowned for their user-friendliness, superior digital control and light yet robust design.

Damage control in case of flooding, water pipes or as a side-effect from fire fighting requires fast and efficient dehumidification. This is why water damage companies all over the world prefer the Dantherm CDT range of mobile dehumidifiers for the job. They are fast and energy-efficient. They offer precise digital settings, service information, easy fault-finding and exact specification of hour and energy consumption as well as readings of temperature and relative humidity. On top of this they are designed for optimal transport and handling.

Speed up the drying process

Dantherm CDT units are also popular within the building industry, because of their user-friendly design and mobility. They offer an effective and carefully controlled means of drying out brick or concrete walls to save both time and money without forcing the process unduly. Furthermore, the CDT units are designed to meet modern demands for low energy consumption.

High-performance and digital control

The CDT range offers capacities from 29 to 86 l/24h and a maximum working temperature of 35°C, as well as superior control of settings and operations. The digital touchscreen display puts you in quick and easy control of humidity and service status. Furthermore, hours and energy consumption can be read off the display.

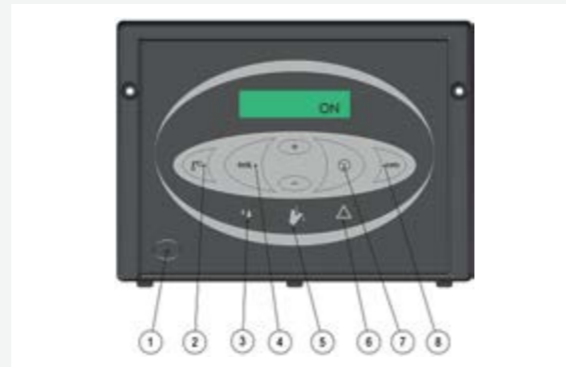

Electronic control

The digital display with integrated humidity control, energy counter, service status and easy fault finding allows optimal dehumidification:

Benefits:

- Digital touchscreen control panel with display
- Accurate hour and kWh counter (reading)
- RH and °C monitoring (reading)
- RH setting
- Easy fault-finding
- Service monitoring function

Digital touchscreen control panel:

1. On-off switch
2. Reading of room temperature
3. Indicator for normal operation (green lamp)
4. Reading of RH value/setting of RH value
5. Indicator for full water container (yellow lamp)
6. Failure indicator (red lamp)
7. Hour counter/setting of service intervals
8. kWh counter

New refrigerant

Fully complying with EU's F-gas regulation, which aims to phase out usage of HFCs, all units use the eco-friendly and durable R454C refrigerant. Ideal for a broad temperature range, it is very suitable for rental and fleet equipment subjected to frequent transportation to and from different sites and offers the flexibility needed by fleet operators. R454C is mildly flammable – check local legislation for any maximum coolant storage limits.

Easy and safe transport

The CDT units have been carefully designed for easy handling and transport. Adjustable and fixed handles ensure safe and convenient handling and operation. Big rubber wheels make the CDT's easy to move both up and down stairs and across seemingly impassable areas. The wheels are in line with the sides of the unit to make it as narrow as possible and to protect doors and panels from unnecessary knocks. During transport and storing, the CDT units can be stacked requiring as little space as possible.

Special versions with air ducts

CDT 30S and CDT 40S are fitted with a 1kW heating element, a high pressure fan and two duct spigots allowing connection of flexible air ducts. This is particularly suitable for drying out wet wooden floors.

Optional remote monitoring

Imagine not having to go on-site and check manually if a dehumidification process has been completed. With the optional integration to Dantherm Group's remote monitoring solution SIMPLIFY CLIMATE SOLUTIONS, you can check the dehumidifying status in real-time from computers, smart phones and tablets no matter where you are. In addition, the solution enables users to remotely monitor and control parameters such as power on/off, alarms, temperature and power consumption.

CDT with condensate pump

The CDT dehumidifiers can be supplied with a condensate pump cassette, which is fitted instead of the water container. It pumps the condensate water into a drain. Using this condensate pump will enable your dehumidifier to run maintenance-free, you will no longer have to empty a heavy reservoir filled with water. The lifting height is max. 3m. The condensate pump cassette is available as accessory.

Technical data

	Dehumidification capacity at		Operating range humidity	Operating range temperature	Height with handle down	Height with handle up	Width	Depth	Weight	Water tank
	20°C/60% RH	30°C/80% RH								
	l/24h	l/24h	%RH	°C	mm	mm	mm	mm	kg	l
CDT 30	15.1	31.9	40-100	3-35	736	1016	426	506	31	7
CDT 30S	14.4	34.4	40-100	3-35	736	1016	426	506	33	7
CDT 40	18.4	43.5	40-100	3-35	823	1190	542	539	40	14
CDT 40S	18.6	43.5	40-100	3-35	823	1190	542	539	43	14
CDT 60	28.4	65.0	40-100	3-35	903	1270	542	539	46	14
CDT 90	37.0	86.5	40-100	3-35	977	977	650	593	62	-



CDT 30S and CDT 40S are fitted with a 1kW heating element, a high pressure fan and two duct spigots, allowing connection of two flexible air ducts Ø100, each up to 5m long.



Big rubber wheels ensure safe and easy manoeuvring.

Applications

- Water damage restoration
- Building drying
- Waterworks
- Dry storing

PORTABLE CONDENSATION DEHUMIDIFIERS CDT 30-30S



- Electronic control display
- Water container with handles
- Automatic stop when water container is full or removed
- High capacity
- Low energy consumption
- F-gas regulation 2020 compliant refrigerant
- Strong and robust cabinet of powder-coated hot galvanized steel with active defrosting
- Epoxy-coated evaporator and condenser
- Adjustable handle
- Plastic bumpers
- Low weight
- Stackable
- Big wheels
- Can be integrated with Remote Monitoring Solution from Dantherm Group

The CDT 30/CDT 30S is a robust, cost-effective and energy-efficient, reliable mobile dehumidifier. It works in accordance with the condensation principle. A fan draws the humid air into the dehumidifier and through an evaporator coil. When passing through the evaporator the air is cooled down to below its dew point temperature, and its content of water vapour is condensed into water, which is collected in the water container.

- CDT 30S:**
- Fitted with a 1kW heating element
 - High pressure fan
 - Two duct spigots, allowing connection of two flexible air ducts Ø100, each up to 5m long

Optional accessories

- Hygrostat with 0.4m cable, jack plug and fitting 396242
- Hygrostat with 3m cable and jack plug 396241
- 1/2" draining tap and screwed hose connector 396243
- Wall bracket CDT 30/CDT 30S: 396247
- Spare filter CDT 30/CDT 30S: 035862
- Cassette with built-in condensate pump CDT 30/CDT 30S: 075616

Specifications	Units	CDT 30	CDT 30S
Capacity (30°C/80% RH)	l/24h	31.9	34.4
Capacity (20°C/60% RH)	l/24h	15.1	14.4
Air flow	m³/h	250	350*
Operating temperature range	°C	3-35	3-35
Operating humidity range	% RH	40-100	40-100
Max. power consumption	W	800	1800 with heating element/800 without
Power supply	V/Hz	230/50	230/50
Sound level @1m	dB(A)	56	56**
Refrigerant		R454c	R454c
Water tank	l	7	7
Protection class		IP X4	IP X4
Height with handle down	mm	736	736
Width	mm	426	426
Depth	mm	506	506
Weight	kg	31	33

*Measured without air ducts mounted.**Measured with air ducts mounted.

PORTABLE CONDENSATION DEHUMIDIFIERS CDT 30-30S

Dimensions

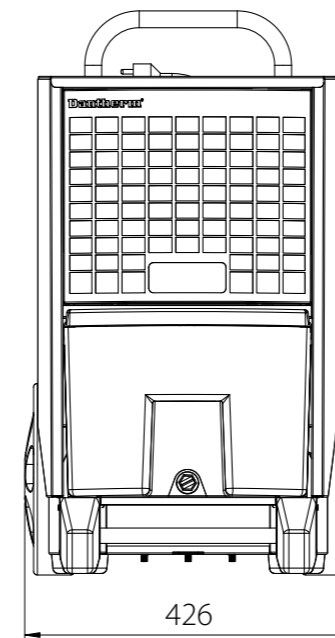

CDT 30

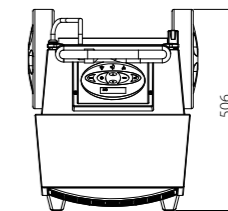
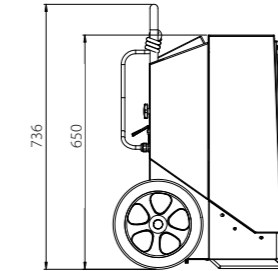

CDT 30S

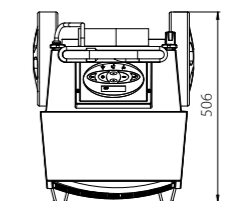
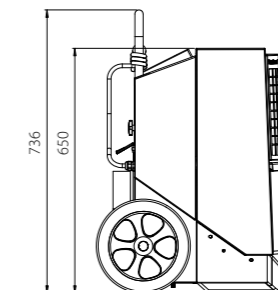

All measurements are in mm

Performance data

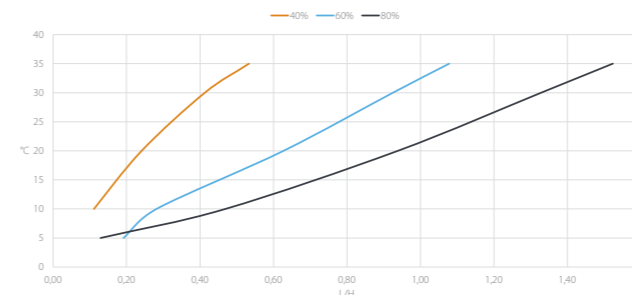

CDT 30
Specific energy consumption (SEC)
0.53 kWh/l at 30°C & 80% RH
0.85 kWh/l at 20°C & 60% RH

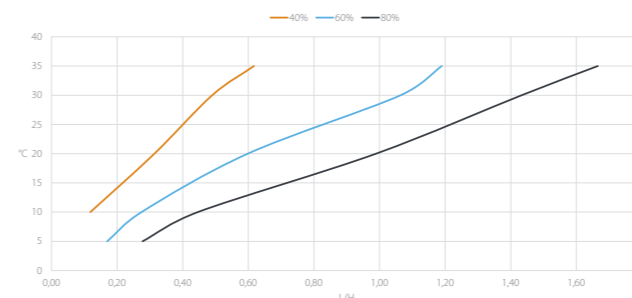

CDT 30S
Specific energy consumption (SEC)
0.51 kWh/l at 30°C & 80% RH
0.86 kWh/l at 20°C & 60% RH

The active, demand-controlled defrosting is activated through a temperature sensor on the evaporator. Defrosting is done by means of hot refrigerant being fed through the evaporator.

PORTABLE CONDENSATION DEHUMIDIFIERS CDT 40-40S



- Electronic control display
- Water container with handles
- Automatic stop when water container is full or removed
- High capacity
- Low energy consumption
- F-gas regulation 2020 compliant refrigerant
- Strong and robust cabinet of powder-coated hot galvanized steel
- Epoxy-coated evaporator with active defrosting and condenser
- Adjustable handle
- Plastic bumpers
- Low weight
- Stackable
- Big wheels
- Can be integrated with Remote Monitoring Solution from Dantherm Group

The CDT 40 is a robust, cost-effective and energy-efficient, reliable mobile dehumidifier. It works in accordance with the condensation principle. A fan draws the humid air into the dehumidifier and through an evaporator coil. When passing through the evaporator the air is cooled down to below its dew point temperature, and its content of water vapour is condensed into water, which is collected in the water container.

CDT 40S:

- Fitted with a 1kW heating element
- High pressure fan
- Two duct spigots, allowing connection of two flexible air ducts Ø100, each up to 5m long

Optional accessories

Hygrostat with 0.4m cable, jack plug and fitting 396242

Hygrostat with 3m cable and jack plug 396241

1/2" draining tap and screwed hose connector 396243

Wall bracket CDT 40/40S: 396248

Spare filter CDT 40/CDT 40S 035973

Cassette with built-in condensate pump CDT 40/CDT 40S 075617

Specifications	Units	CDT 40	CDT 40S
Capacity (30°C/80% RH)	l/24h	43.5	43.5
Capacity (20°C/60% RH)	l/24h	18.4	18.6
Air flow	m ³ /h	350	560*
Operating temperature range	°C	3-35	3-35
Operating humidity range	% RH	40-100	40-100
Max. power consumption	W	900	1900 with heating element/900 without
Power supply	V/Hz	230/50	230/50
Sound level @1m	dB(A)	57	58**
Refrigerant		R454c	R454c
Water tank	l	14	14
Protection class		IP X4	IP X4
Height with handle down	mm	823	823
Width	mm	542	542
Depth	mm	539	539
Weight	kg	40	43

*Measured without air ducts mounted.**Measured with air ducts mounted.

PORTABLE CONDENSATION DEHUMIDIFIERS CDT 40-40S

Dimensions

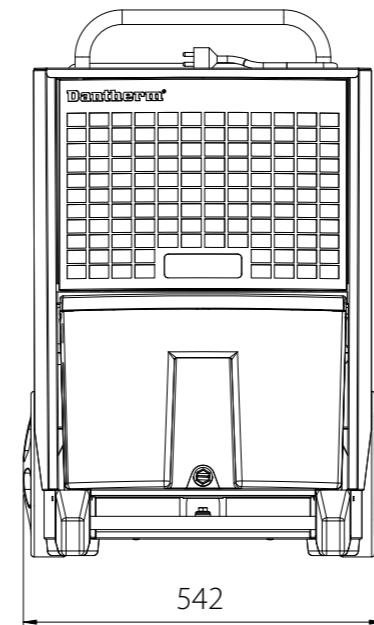

CDT 40

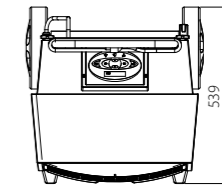
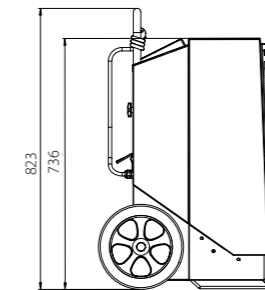

CDT 40S

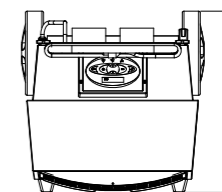
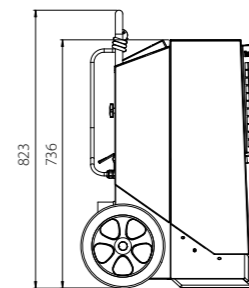

All measurements are in mm

Performance data

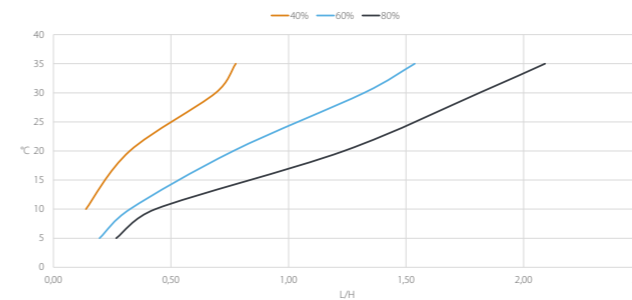

CDT 40

Specific energy consumption (SEC)

0.44 kWh/l at 30°C & 80% RH
0.78 kWh/l at 20°C & 60% RH

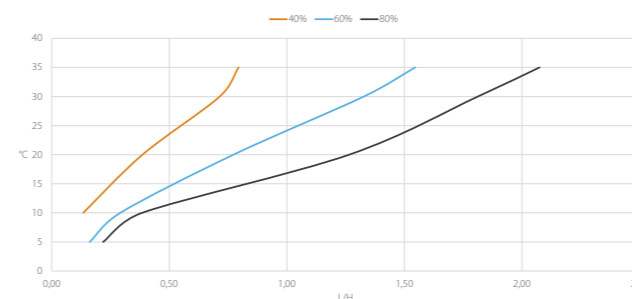

CDT 40S

Specific energy consumption (SEC)

0.44 kWh/l at 30°C & 80% RH
0.77 kWh/l at 20°C & 60% RH

The active, demand-controlled defrosting is activated through a temperature sensor on the evaporator. Defrosting is done by means of hot refrigerant being fed through the evaporator.

PORTABLE CONDENSATION DEHUMIDIFIERS CDT 60



CDT 60



- Electronic control display
- High capacity
- Low energy consumption
- F-gas regulation 2020 compliant refrigerant
- Strong and robust cabinet of powder-coated hot galvanized steel
- Epoxy-coated evaporator with active defrosting and condenser
- Adjustable handle
- Plastic bumpers
- Low weight
- Stackable
- Big wheels
- Can be integrated with Remote Monitoring Solution from Dantherm Group
- Fitted with a drain outlet for connection to a 1/2" water hose

The CDT 60 is a robust, cost-effective and energy-efficient, reliable mobile dehumidifier. It works in accordance with the condensation principle. A fan draws the humid air into the dehumidifier and through an evaporator coil. When passing through the evaporator the air is cooled down to below its dew point temperature, and its content of water vapour is condensed into water, which is led via a drip tray to a drain.

The active, demand-controlled defrosting is activated through a temperature sensor on the evaporator. Defrosting is done by means of hot refrigerant being fed through the evaporator.

Optional accessories

	Hygrostat with 0.4m cable, jack plug and fitting 396242		1/2" draining tap and screwed hose connector 396243
	Hygrostat with 3m cable and jack plug 396241		Cassette with built-in condensate pump 075617
	Wall bracket 396248		Spare filter 036452

PORTABLE CONDENSATION DEHUMIDIFIERS CDT 60

Dimensions

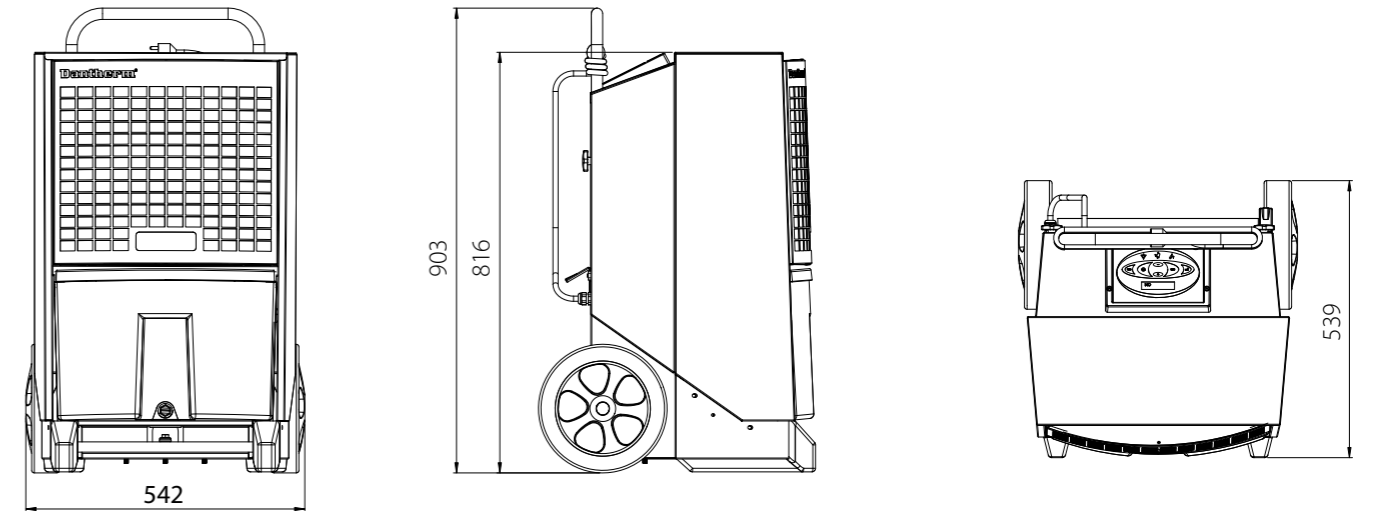

All measurements are in mm

Performance data

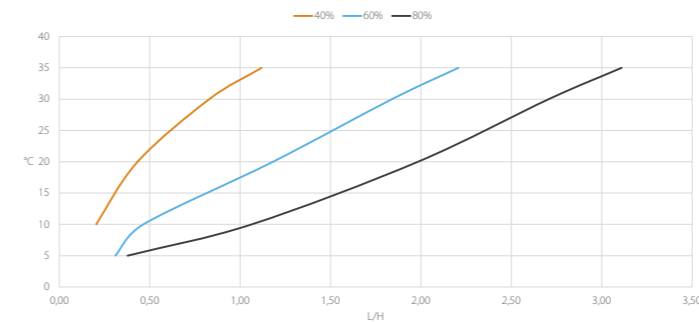

CDT 60

Specific energy consumption (SEC)
0.42 kWh/l at 30°C & 80% RH
0.75 kWh/l at 20°C & 60% RH

Specifications	Units	CDT 60
Capacity (30°C/80% RH)	l/24h	65.0
Capacity (20°C/60% RH)	l/24h	28.4
Air flow	m ³ /h	725
Operating temperature range	°C	3-35
Operating humidity range	% RH	40-100
Max. power consumption	W	1300
Power supply	V/Hz	230/50
Sound level @1m	dB(A)	57
Refrigerant		R454c
Water tank	l	14
Protection class		IP X4
Height with handle down	mm	903
Width	mm	542
Depth	mm	539
Weight	kg	46

PORTABLE CONDENSATION DEHUMIDIFIERS CDT 90



CDT 90



- Electronic control display
- Water container with handles
- Automatic stop when water container is full or removed
- High capacity
- Low energy consumption
- F-gas regulation 2020 compliant refrigerant
- Strong and robust cabinet of powder-coated hot galvanized steel
- Epoxy-coated evaporator with active defrosting and condenser
- Adjustable handle
- Plastic bumpers
- Low weight
- Big wheels
- Can be integrated with Remote Monitoring Solution from Dantherm Group

The CDT 90 is a robust, cost-effective and energy-efficient, reliable mobile dehumidifier. It works in accordance with the condensation principle. A fan draws the humid air into the dehumidifier and through an evaporator coil. When passing through the evaporator the air is cooled down to below its dew point temperature, and its content of water vapour is condensed into water, which is collected in the water container.

The active, demand-controlled defrosting is activated through a temperature sensor on the evaporator. Defrosting is done by means of hot refrigerant being fed through the evaporator.

Optional accessories



Hygrostat with 0.4m cable, jack plug and fitting 396242



Hygrostat with 3m cable and jack plug 396241

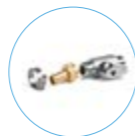

1/2" draining tap and screwed hose connector 396243



Spare filter 036849

PORTABLE CONDENSATION DEHUMIDIFIERS CDT 90

Dimensions

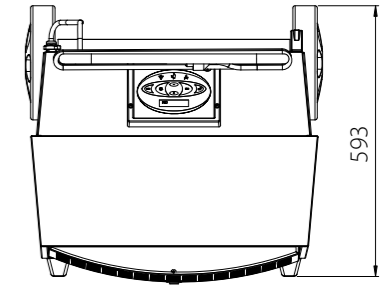
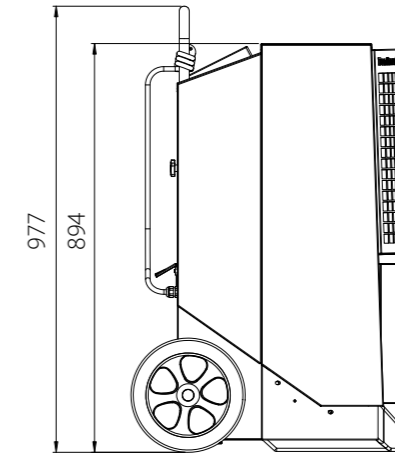
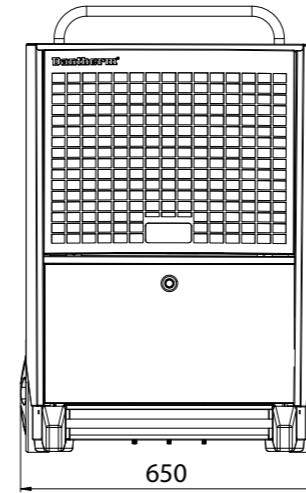

All measurements are in mm

Performance data

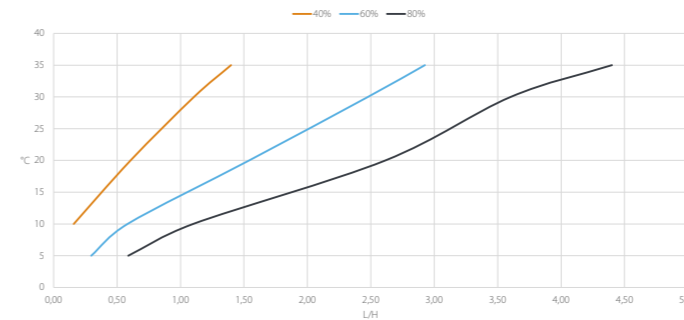

CDT 90







Specific energy consumption (SEC)

0.48 kWh/l at 30°C & 80% RH
0.81 kWh/l at 20°C & 60% RH

Specifications	Units	CDT 90
Capacity (30°C/80% RH)	l/24h	86.5
Capacity (20°C/60% RH)	l/24h	37
Air flow	m ³ /h	1000
Operating temperature range	°C	3-35
Operating humidity range	% RH	40-100
Max. power consumption	W	1900
Power supply	V/Hz	230/50
Sound level @1m	dB(A)	57
Refrigerant		R454c
Water tank	l	drain outlet for connection to a 1/2" water hose
Protection class		IP X4
Height with handle down	mm	977
Width	mm	650
Depth	mm	593
Weight	kg	62

ACCESSORIES

CDT 30-30S-40-40S-60-90

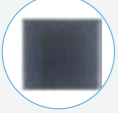
Illustration	Accessory	Products	Code
	Hygrostat with 0.4m cable, jack plug and fitting	ALL	396242 396241
	Hygrostat with 3m cable and jack plug		
	1/2" draining tap and screwed hose connector	ALL	396243
	Remote monitoring solution Simplify Climate Solutions	ALL	Please contact sales for more information
	Condensate pump in a cassette	CDT 30/30S CDT 40/40S/60	075616 075617
	Wall bracket	CDT 30/30S CDT 40/40S/60	396247 396248
	Spare filter	CDT 30/CDT 30S CDT 40/CDT 40S CDT 60 CDT 90	035862 035973 036452 036849

Dantherm®

CLIMATE SOLUTIONS

Dantherm A/S

Marienlystvej 65
DK-7800 Skive
Denmark
t. +45 96 14 37 00

Dantherm Ltd.

Unit 12, Galliford Road
Maldon CM9 4XD
United Kingdom
t. +44 (0)1621 856611

Dantherm GmbH

Oststraße 148
22844 Norderstedt
Germany
t. +49 40 526 8790

Dantherm S.p.A.

Via Gardesana 11
37010 Pastrengo (VR)
Italy
t. +39 045 6770533

Dantherm Sp. z o.o.

ul. Magazynowa 5a
62-023 Gądki
Poland
t. +48 61 65 44 000

Dantherm SP S.A.

C/Calabozos 6
(Polígono Industrial)
28108 Alcobendas, Madrid
Spain
t. +34 91 661 45 00

Dantherm SAS

23 rue Eugène Hénaff
69694 Vénissieux Cedex
France
t. +33 4 78 47 11 11

Dantherm AS

Løkkeåsveien 26
3138 Skallestad
Norway
t. +47 33 35 16 00

Dantherm AB

Fridhemsvägen 3
602 13 Norrköping
Sweden
t. +46 (0)11 19 30 40

Dantherm LLC

Transportnaya 22/2
142800, Stupino
Moscow
Russia
t. +7 (495) 642 444 8

MCS China

Unit 2B, No. 512
Yunchuan Road
Baoshang, Shanghai, 201906
China
t. +8621 61486668

AirCenter AG

Täferstrasse 14
CH-5405 Baden Dättwil
Switzerland
t. +41 43 500 00 50

Heylo GmbH

Im Finigen 9
28832 Achim
Germany
t. +49 4202 97550

SET Energietechnik GmbH

August-Blessing-Straße 5
71282 Hemmingen
Germany
t. +49 7150 94540

Dealer:

KEEP UPDATED
FOLLOW US ON:



danthermgroup.com